



# COLUMNS

Featuring Poly-Classic Columns and Wood Columns  
by Turncraft

# WE MAKE COLUMNS EASY

**1** PICK A  
SHAFT

**2** PICK HEIGHT  
& WIDTH

**3** PICK A CAP  
& BASE

**4** TAKE IT  
HOME

**5** INSTALL  
WITH EASE



## WE TURN OUT QUALITY

### A LITTLE ABOUT US

- Began manufacturing wood columns in 1963
- Added wood porch posts in 1969.
- The Architectural division was added in 1989.
- Introduced the Poly-Classic® Composite Products in 1994.
- PVC Craftsman's Products added in 2004.
- Introduced the DuraGlass Pultruded Products in 2006.

Architects and builders have chosen Turncraft® columns because of our thoughtful design, exceptional materials, fine workmanship, superior assembly, and extensive selection. Precise historical research and authentic architectural specifications reflect our dedication to the quality you can expect from all of our products from in-stock columns to custom-built solutions.

## TURNCRAFT PRODUCTS MADE IN THE U.S.A



### DID YOU KNOW?

- All Turncraft products, wood and composite, are manufactured in the U.S.A. in our own factories.
- Our experienced craftsmen take extreme care and pride in the products we produce for our customers, all the way from making our own molds to the finished products.
- Turncraft® provides the largest selection of products from any manufacturer. Period!
- All Turncraft® products are designed to work together for perfectly matched columns regardless of the type of materials used.

# TURNCRAFT MIX-N-MATCH

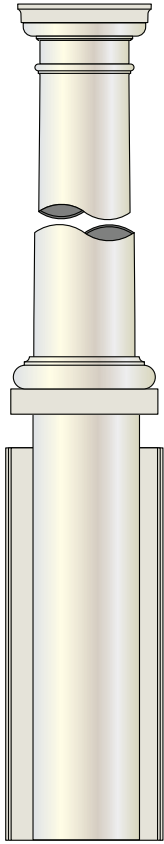

**FRP structural round and square column with Craftsman pedestal.**  
 No load support is required since the FRP column is load bearing (unless split). The column should be installed following our normal installation instructions with the exception that the base is not placed and attached. The base should be held above the height of the pedestal. Then the Craftsman pedestal is installed around the FRP column. To finish the installation, the base is then lowered to the top of the pedestal and attached.

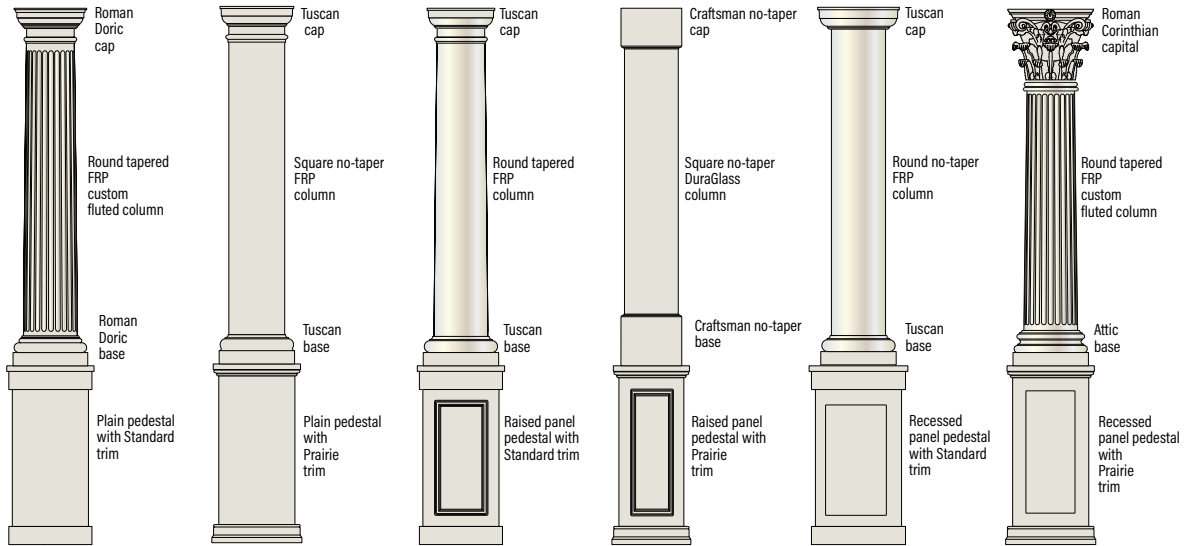

## Craftsman non-structural column with a Craftsman pedestal.

Load support is required. Manufactured using an E-Z lock joint design, Craftsman Series columns are made from expanded cellular PVC, so like their wooden precursors, they can be trimmed, drilled, and fastened with traditional carpentry tools. Unlike traditional wooden columns that required exceptional joinery work and assembly, Craftsman Series columns are ready for quick and simple installation. Their hollow centers are also useful as channels for downspouts, wiring, and plumbing.

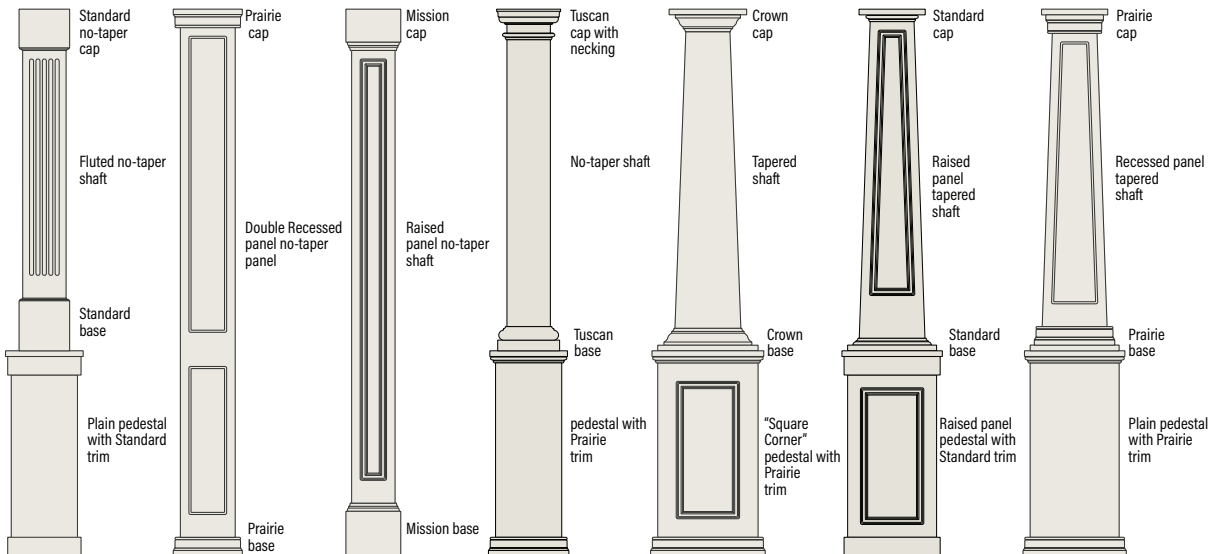
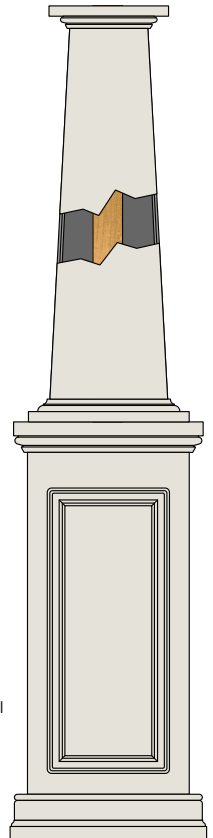

# POLY-CLASSIC® FRP ROUND COLUMNS

## TRANSFORMING STRUCTURES WITH FRP COLUMNS

Turncraft Poly-Classic® FRP columns are the product of choice for homeowners and builders who demand beauty, value, and performance. Poly-Classic® FRP columns are architecturally proportioned from rotocast fiberglass-reinforced polymer—the most advanced construction material in the world—so that pound for pound they are stronger than concrete, steel, or aluminum.

## TIMESAVER CAP AND BASE

Our TimeSaver cap and base offers the easiest and quickest installation in the industry.

- Quick-Fit pressure tabs
- Made out of fiber-reinforced recycle ABS (acrylonitrile butadiene styrene)
- Designed for use on tapered round FRP columns in 8", 10", and 12" sizes.
- Extremely strong and durable
- Self-aligning with no fasteners
- Excellent paint adhesion
- Fast installation



## ORNAMENTAL CAPITALS

Designed with crisp, true architectural detail, Turncraft ornamental capitals artfully capture natural themes and images. Made from composite materials that offer increased durability and low maintenance, ornamental capitals are available for round and square Poly-Classic® columns. Visit [Turncraft.com](http://Turncraft.com) to see the large selection of ornamental capitals available.



## PLAN TYPES

Poly-Classic® FRP round columns are available in the below plan types. Please specify when you order. (Fractional components shown are typical. Customer may specify actual returns, wall thicknesses, etc.)

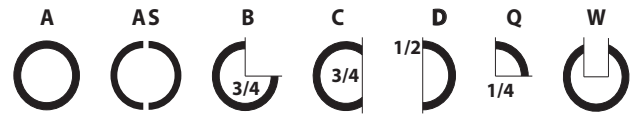

FRP  
Tuscan  
Tapered  
Round Smooth

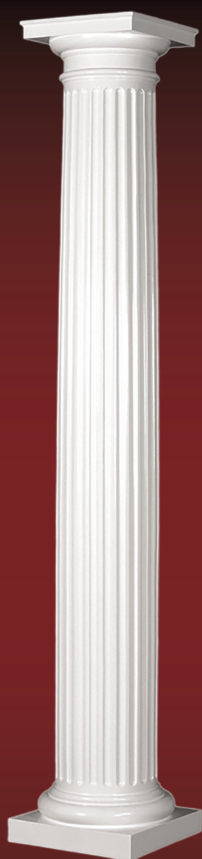

FRP  
Tuscan  
Tapered  
Round Fluted



FRP  
Tuscan  
Non-Tapered  
Round Smooth

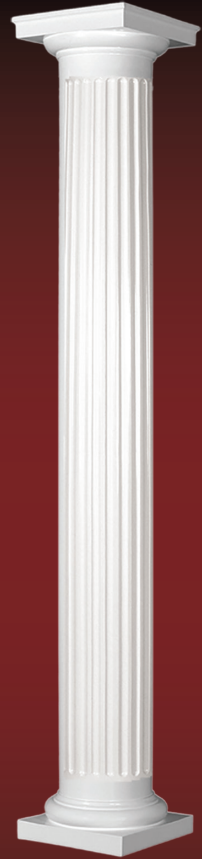

FRP  
Tuscan  
Non-Tapered  
Round Fluted

## POLY-CLASSIC® FRP ROUND TAPERED COLUMNS

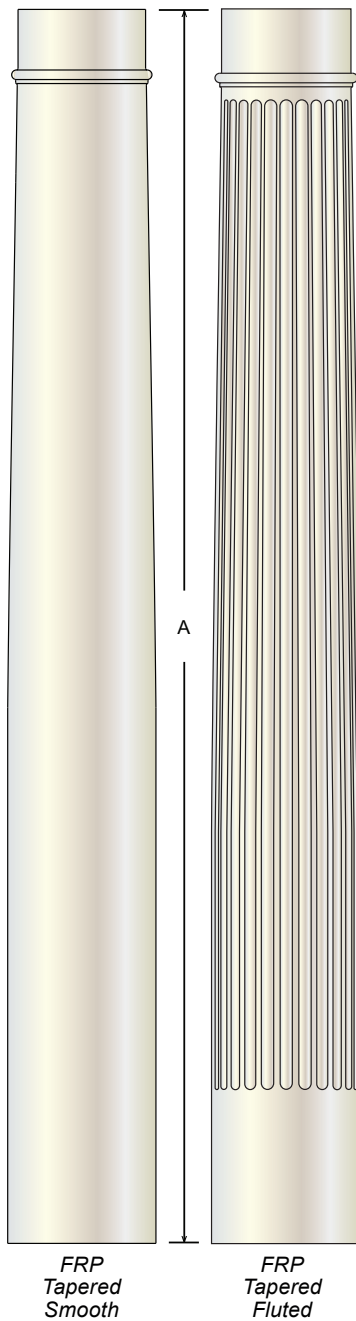

Bottom Diameter	Available Heights (A)												Load (pounds)		
	4'	5'	6'	8'	9'	10'	12'	14'	16'	18'	20'	22'	24'	Concentric	Eccentric
6"		✓	✓	✓										6,000	6,000
8"		✓	✓	✓	✓	✓								10,000	6,600
10"	✓	✓	✓	✓	✓	✓	✓							14,000	10,720
12"		✓	✓	✓	✓	✓	✓	✓						18,000	13,200
14"			✓	✓	✓	✓	✓	✓	✓	✓				20,000	11,520
16"		✓	✓	✓	✓	✓	✓	✓	✓	✓				20,000	13,200
18"				✓	✓	✓	✓	✓	✓	✓	✓	✓		20,000	9,040
20"			✓	✓	✓	✓	✓	✓	✓	✓	✓	✓		20,000	18,960
24"				✓		✓	✓	✓	✓	✓	✓	✓		20,000	13,200

- Weatherproof, insect-proof, rot-proof - virtually maintenance free.
- Use acrylic-latex primer and paint for best results.
- Tuscan caps and Tuscan or Attic bases install around shaft.
- Tuscan cap and base sets for 8", 10" and 12" columns are recycled ABS. For 6" & 14" through 24" columns, bases are FRP, caps are polyurethane.
- All FRP columns are available custom fluted - please specify cap and base style plus finished height when ordering.

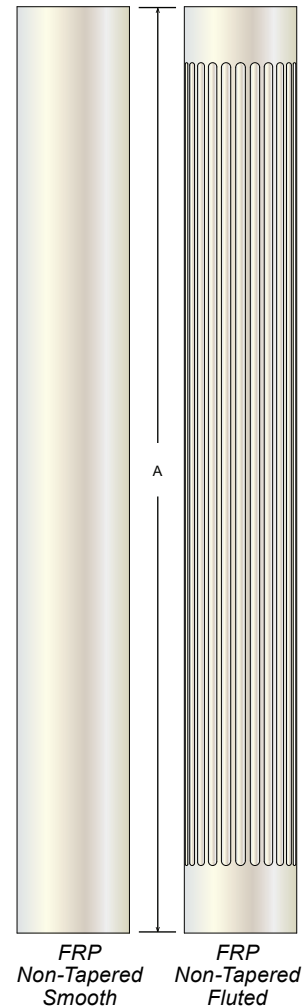
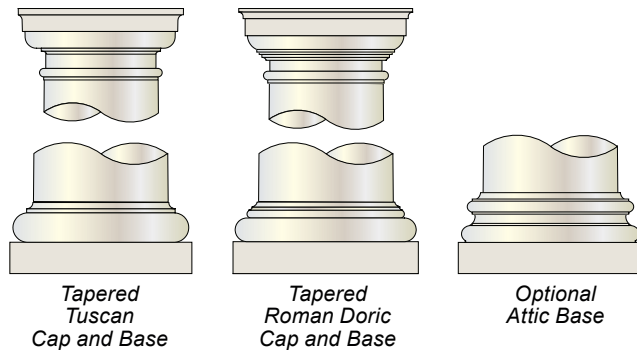

## POLY-CLASSIC® FRP ROUND NON-TAPERED COLUMNS

Column Diameter	Available Heights (A)							Load (pounds)	
	8'	9'	10'	11'	12'	14'	15'	Concentric	Eccentric
8"	✓	✓	✓					10,000	8,240
10"	✓	✓	✓					14,000	11,520
12"	✓	✓	✓		✓			18,000	11,520
14"	✓		✓		✓	✓		20,000	18,120
16"	✓	✓	✓					20,000	13,200
18"	✓	✓	✓	✓				20,000	9,040
20"	✓	✓	✓	✓				20,000	18,960
24"	✓	✓	✓		✓	✓	✓	20,000	13,200

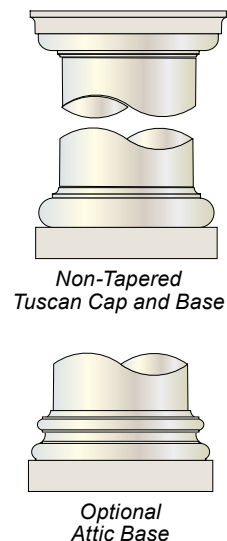

# POLY-CLASSIC® FRP PRO SERIES SQUARE COLUMNS

## LIMITED LIFETIME WARRANTY

Poly-Classic® FRP columns are virtually maintenance-free. They are impervious to termite and carpenter ant attack as well as staining and decaying fungi. High-humidity environments have no effect on these non-porous, waterproof columns. All Turncraft Poly-Classic® columns are covered by a limited lifetime warranty to the original purchaser. Warranty details are available from your distributor or our website-[Turncraft.com](http://Turncraft.com).

## ORNAMENTAL CAPITALS

Designed with crisp, true architectural detail, Turncraft ornamental capitals artfully capture natural themes and images. Made from composite materials that offer increased durability and low maintenance, ornamental capitals are available for round and square Poly-Classic® columns. Visit [Turncraft.com](http://Turncraft.com) to see the large selection of ornamental capitals available.



## PLAN TYPES

Poly-Classic® FRP Pro Series square columns are available in the below plan types. Please specify when you order.

(Fractional components shown are typical. Customer may specify actual returns, wall thicknesses, etc.)



Pro Series  
Tuscan  
Smooth

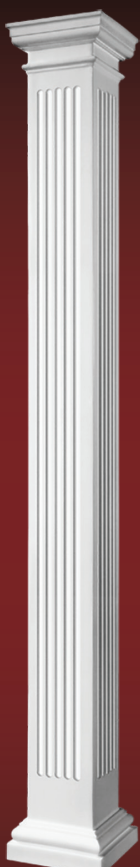

Pro Series  
Tuscan  
Fluted



Pro Series  
Craftsmn  
Smooth



Pro Series  
Tuscan  
with Pedestal

**POLY-CLASSIC® FRP PRO SERIES SQUARE NON-TAPERED COLUMNS**

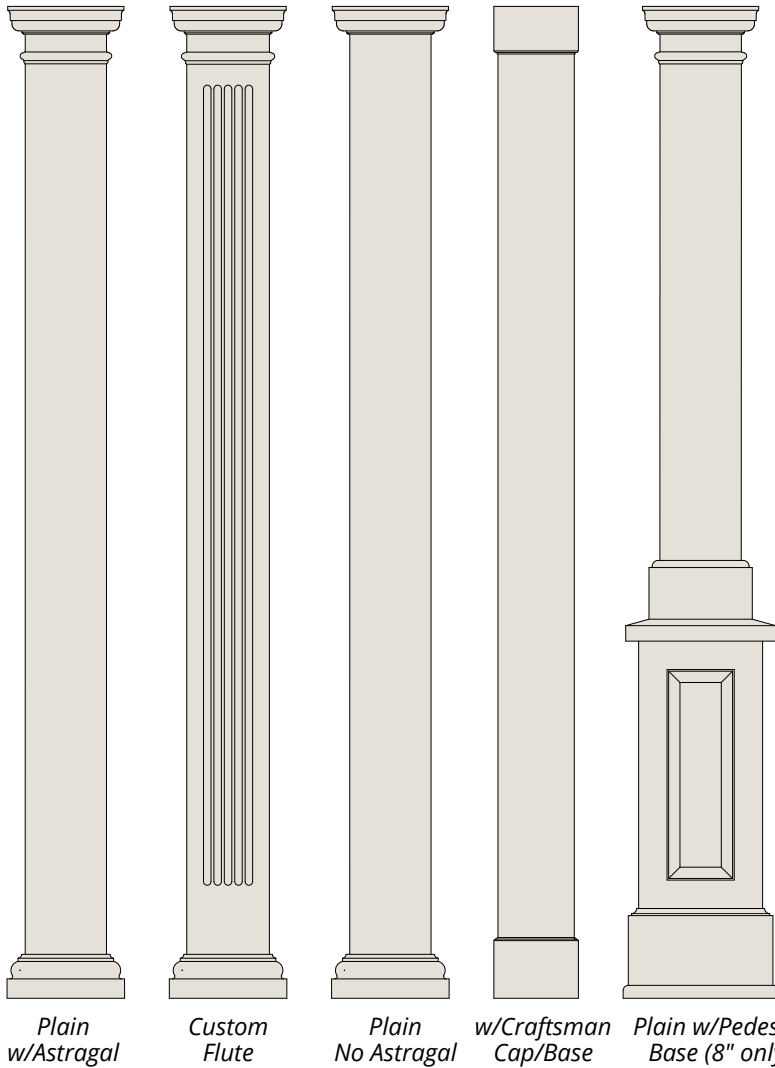

# Pro-Series

The New Square Pro-Series FRP Columns is lighter and cost less with the same load bearing capacity as the Standard Square FRP Column.

- Optional Adjustable Neck Ring
- Craftsman & Tuscan Cap & Base Options including Timesaver (8" & 10")

Column Nominal Width	Net Width	Inside Width (maximum)	Shaft Height	Number of Flutes	Width of Flutes	Load Bearing Capacity*
6"	5 5/8"	4 5/8"	8'	20	1/2"	6,000 lb.
			9'			
			10'			
8"	7 5/8"	6 7/8"	8'	20	11/16"	10,000 lb.
			9'			
			10'			
			12'			
10"	9 5/8"	8 7/8"	8'	20	1"	12,800 lb.
			9'			
			10'			
			12'			
12"	11 3/4"	11"	8'	20	1 5/16"	18,000 lb.
			9'			
			10'			
			12'			
			14'			
			16'			
14"	14"	12 3/4"	8'	20	1 1/2"	20,000 lb.
			9'			
			10'			
			12'			
			14'			
			15'			

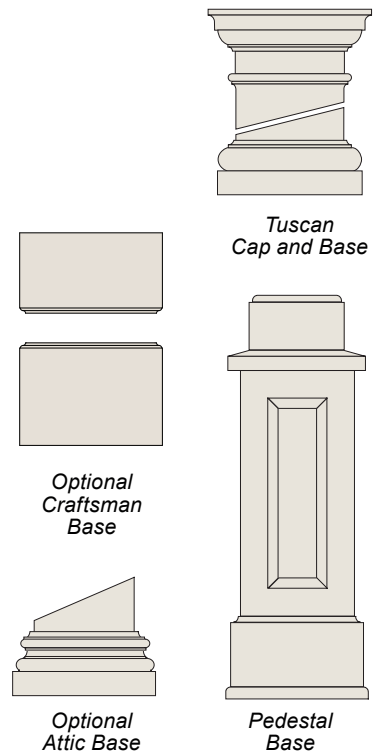

\* Load capacities are reduced when loads are not centered. Full documentation online at [turncraft.com](http://turncraft.com)

# POLY-CLASSIC® DURAGLASS™ SQUARE COLUMNS

## LIGHTWEIGHT FIBERGLASS COLUMNS

Poly-Classic® DuraGlass™ square columns from Turncraft offer the classic beauty that homeowners and commercial property owners appreciate. Made from lightweight fiberglass, these columns are easy to cut, easy to install, and strong enough to carry heavy loads. Like other Poly-Classic® columns, DuraGlass™ square columns are decay resistant and require little maintenance. They are simply beautiful. Don't let the lightweight material fool you. DuraGlass™ columns have an extremely high strength-to-weight ratio, and pound-for-pound are stronger than steel.

## PLAN TYPES

Poly-Classic® Duraglass™ columns are available in the following plan types. Please specify when you order. (Fractional components shown are typical. Customer may specify actual returns, wall thicknesses, etc.)



## TIMESAVER FOR 8" NON-TAPERED COLUMNS

New to the Turncraft product line is our 8" square TimeSaver cap and base product. This new cap and base employs the same quick-fit installation as our round 8", 10", and 12" TimeSaver.

Our TimeSaver cap and base offers the easiest and quickest installation in the industry.

*Customers claim:  
"The TimeSaver cap  
and base has cut our  
installation time in half."*



DuraGlass™  
Tuscan  
Non-tapered  
Square



DuraGlass™  
Tuscan  
Non-tapered  
Square with Neck Molding



DuraGlass™  
Bungalow  
Tapered  
Square



2014 DWM  
Magazine Readers  
Choice Award  
Winner



  
**TURNCRAFT®**  
 THE WORLD'S FINEST COLUMNS AND POSTS



Introducing the  
**ALL NEW**  
**MODERN FARMHOUSE**  
 DuraGlass™  
 Square Column



- Modern style
- Structural, Load-Bearing
- Cap, Base & Installation Kit included

**Easy 3 Step Installation:**

1. Measure & Cut to length
2. Attach Mounting Plates & Slide C&B into Position
3. Clean, Prime then Paint

Nominal Width	Available Heights				Load Capacity
	8'	9'	10'	12'	
8"	✓	✓	✓	✓	5,000

Patent Pending  
 ©2024 Turncraft, All Rights Reserved

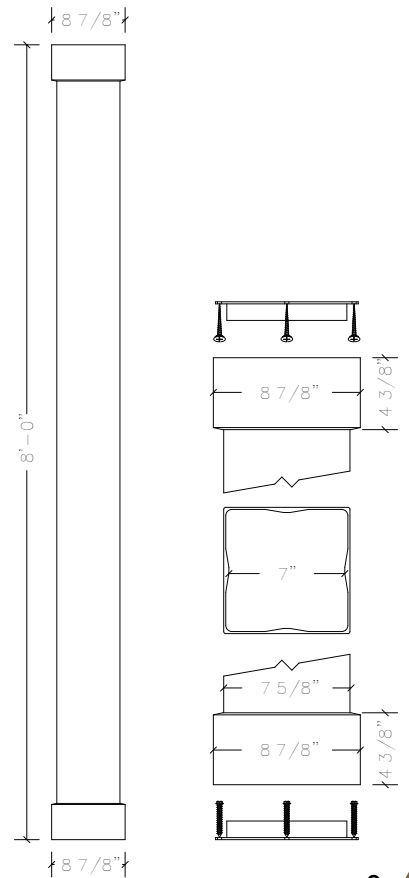

## DURAGLASS™ PULTRUDED NON-TAPER SQUARE COLUMNS

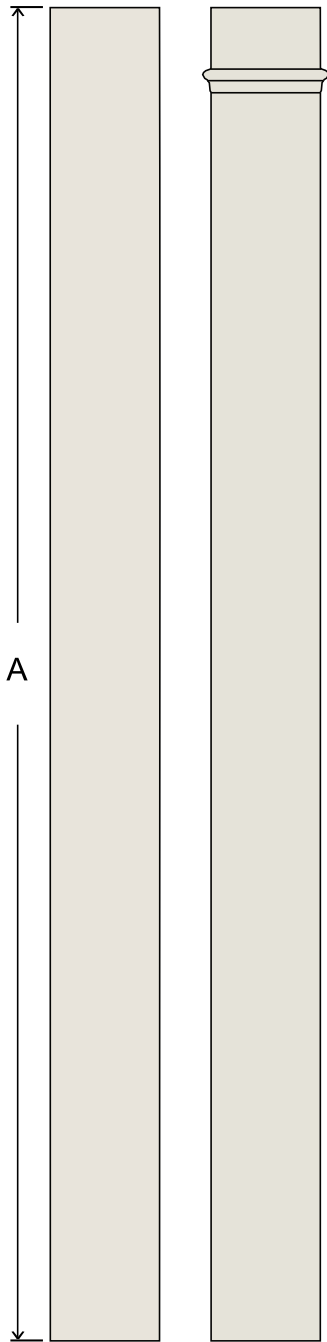

DuraGlass™ Square

DuraGlass™ Square with Neck

Nominal Width *	Shaft		Available Heights (A)												Load Capacity
	Outside	Inside	6'	8'	9'	10'	12'	14'	16'	18'	20'	22'	24'		
	B	C													
8"	7 5/8"	7 1/8"	✓	✓	✓	✓	✓							5,000	
10"	9 5/8"	9 1/8"	✓	✓	✓	✓	✓							6,000	
12"	11 3/4"	11 1/4"	✓	✓	✓	✓	✓							7,000	
14"	14"	11 3/4"	✓	✓	✓	✓	✓	✓	✓	✓	✓			10,000	
16"	16"	13 3/4"	✓	✓	✓	✓	✓	✓	✓	✓	✓			10,000	
18"	18"	15 3/4"		✓	✓	✓	✓	✓	✓	✓	✓	✓	✓	10,000	
20"	20"	17 3/4"		✓	✓	✓	✓	✓	✓	✓	✓	✓	✓	10,000	

\* Actual width is 3/8 less than nominal

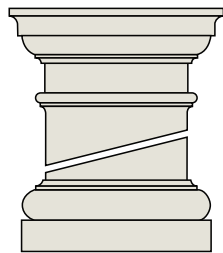

DuraGlass™ Square Cap and Base

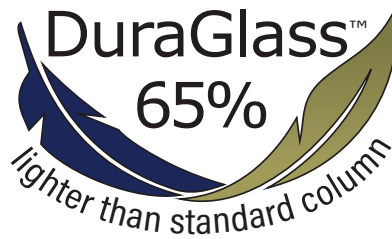
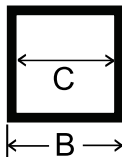

Structural  
(10,000 lb)

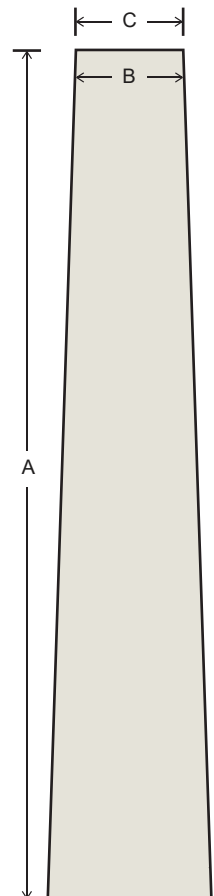

DuraGlass™ Tapered

## DURAGLASS™ TAPERED SQUARE BUNGALOW COLUMNS

Nominal Width *	Shaft		Available Heights (A)				Load Capacity
	Inside	Outside	5'	6'	8'	10'	
	B	C					
10" > 6"	5"	5 5/8"	✓	✓	✓	✓	10,000
12" > 8"	7"	7 5/8"	✓	✓	✓	✓	10,000
16" > 12"	11"	11 5/8"	✓	✓	✓	✓	10,000

\* Actual width is 3/8 less than nominal

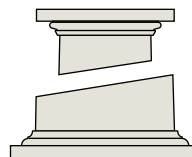

Bungalow PVC Cap and Base

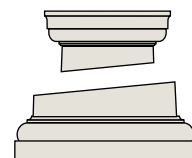

Pulltruded Tuscan Cap and Base

# POLY-CLASSIC® POLY POST

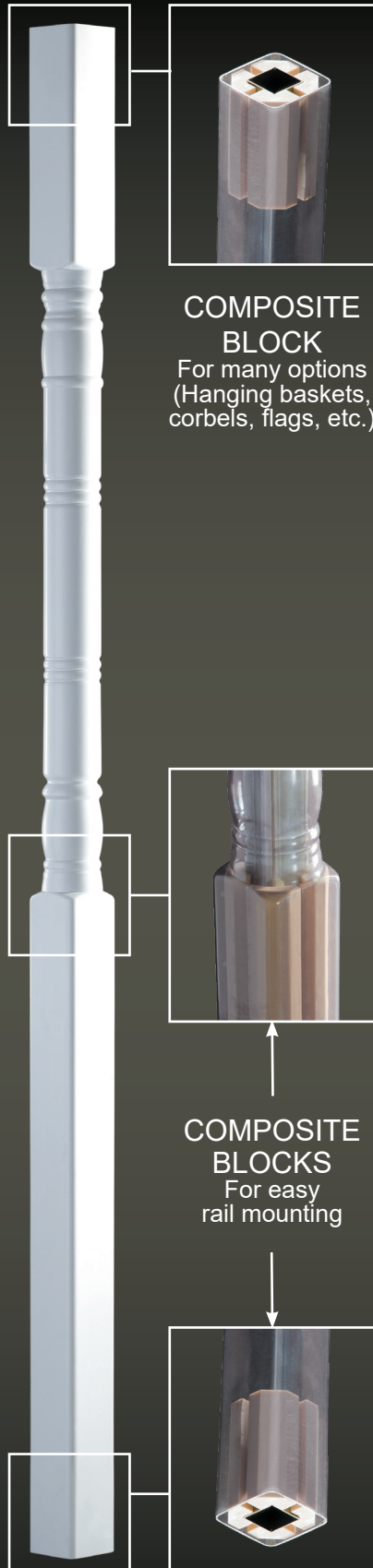

## COMPOSITE BLOCK

For many options  
(Hanging baskets,  
corbels, flags, etc.)

## COMPOSITE BLOCKS

For easy  
rail mounting

## POLY-CLASSIC® PORCH POSTS

Excellent design, performance, and low maintenance are built into every Turncraft Poly-Classic® porch post. For easy rail attachment and substantial load-bearing strength, each Poly-Classic® porch post has a galvanized steel square core and sturdy inserts at critical connection points. Constructed from seamless window grade vinyl with UV inhibitor, Poly-Classic® porch posts are delivered with a matte white finish but can be painted to match your project. They will deliver eye-catching beauty for many years to come without the maintenance of traditional products. Installation hardware is included with the post.

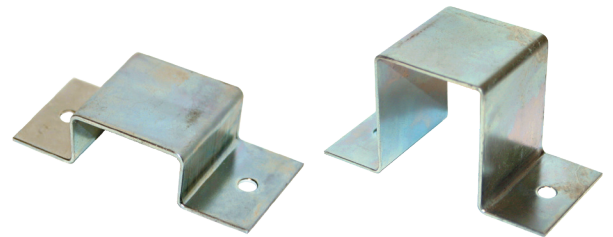

Includes two  
standard brackets.

Larger brackets  
for uplift (1500 lb.)  
sold separately.

## POLY POSTS

Nominal Width	Height	Actual Width	Load (pounds)
5"	8'	4 1/4"	3,000
5"	9'	4 1/4"	3,000

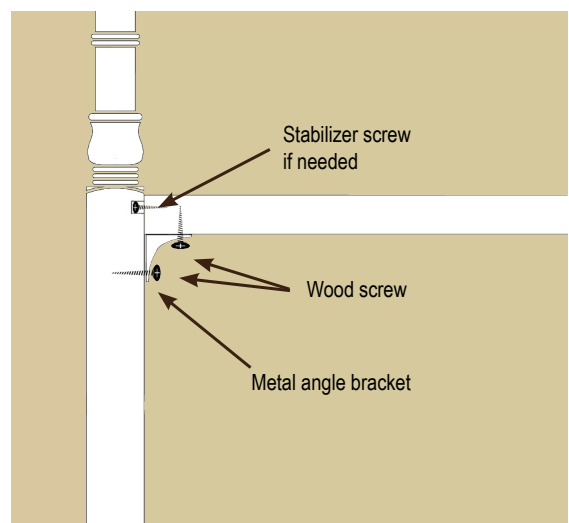

# POLY-CLASSIC® CRAFTSMAN TAPERED COLUMNS

## CRAFTSMAN SERIES

Craftsman Series column panels are not prone to the same environmental damage as real wood, like splitting or cracking. Their E-Z Lock joints will not separate due to disproportionate changes in panel dimensions common to wooden Craftsman columns. With two coats of acrylic latex paint, Poly-Classic® Craftsman Series columns will deliver years of service as promised by their limited lifetime warranty.

## PLAN TYPES

Craftsman Series are available in the following plan types. Please specify when you order. (Customer may specify actual returns, wall thicknesses, etc.) Plans O & N are available only as non-tapered.

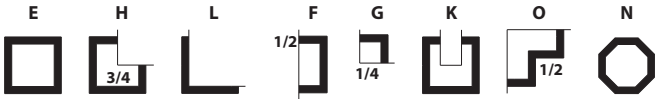

## PRECISION MITER JOINTS

Vertical edges of Craftsman shafts (tapered, non-tapered, pedestal and newel post styles) all incorporate the E-Z Lock miter joint for consistently straight miters.

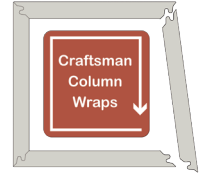

## PANEL STYLES

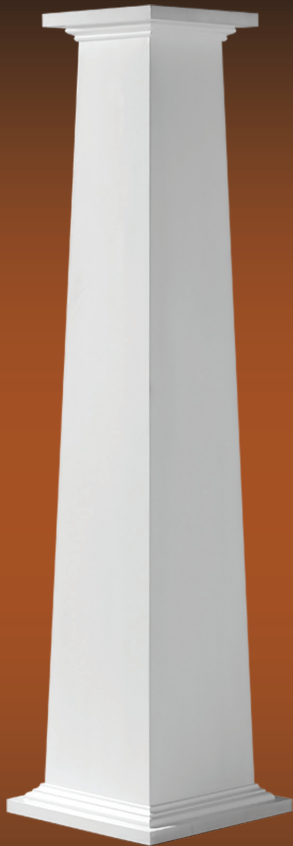
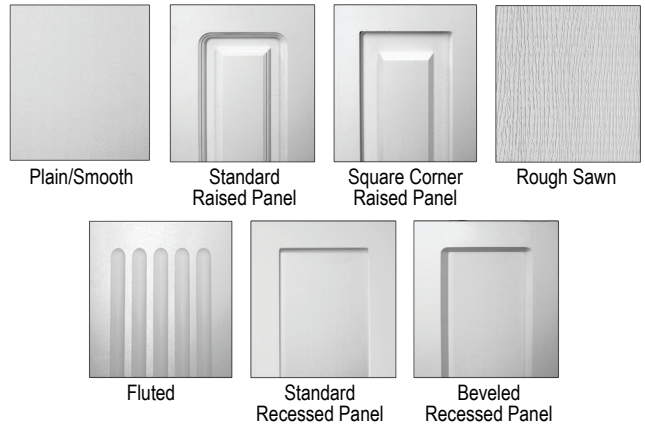

Craftsman  
Standard  
Tapered  
Square

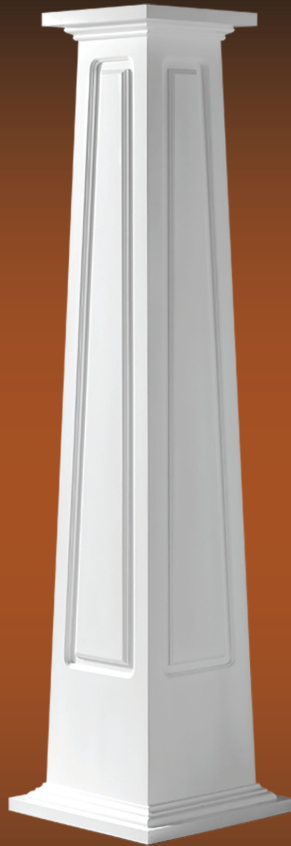

Craftsman  
Standard  
Tapered  
Square with Raised Panels

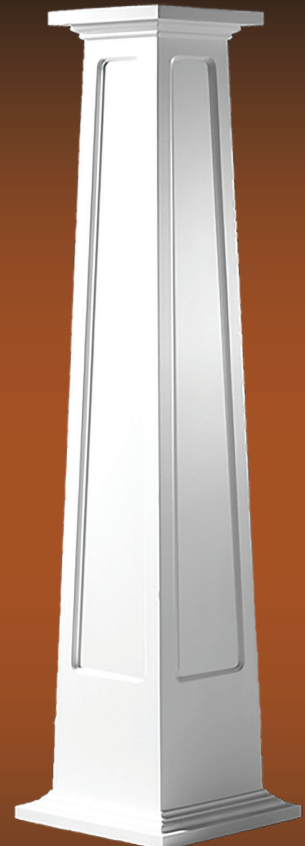

Craftsman  
Standard  
Tapered  
Square with Recessed Panels

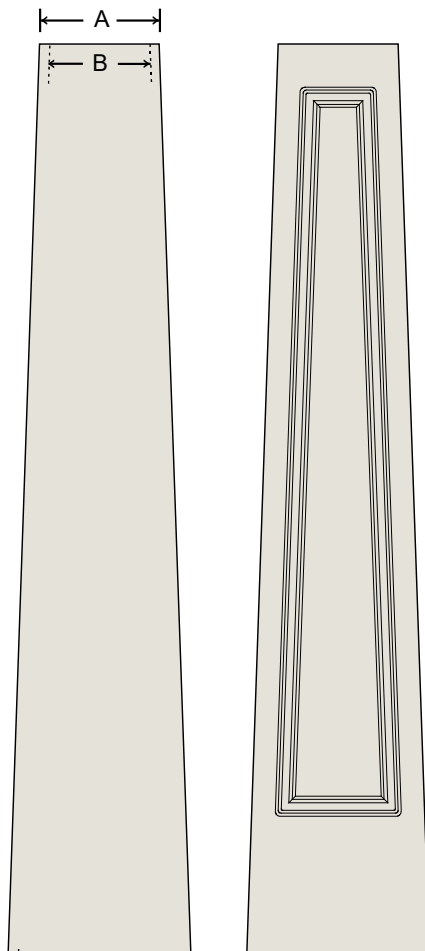

## PVC CRAFTSMAN SERIES TAPERED COLUMN WRAP

Bottom Width x Top Width	Width		Available Heights (A)					
	A	B	4'	5'	6'	8'	9'	10'
10" > 6"	5 5/8"	4 3/8"	✓	✓	✓	✓	✓	✓
12" > 8"	7 5/8"	6 3/8"	✓	✓	✓	✓	✓	✓
16" > 12"	11 5/8"	10 3/8"	✓	✓	✓	✓	✓	✓
20" > 14"	13 5/8"	12 3/8"	✓	✓	✓	✓	✓	✓
24" > 16"	15 5/8"	14 3/8"	✓	✓	✓	✓	✓	✓

## NEW! ROUGH SAWN PVC CRAFTSMAN SERIES TAPERED COLUMN WRAP



Bottom Width x Top Width	Width		Available Heights (A)					
	A	B	4'	5'	6'	8'	9'	10'
10" > 6"	5 5/8"	4 3/8"	✓	✓	✓	✓	✓	✓
12" > 8"	7 5/8"	6 3/8"	✓	✓	✓	✓	✓	✓

- \* Limited Lifetime Warranty
- \* Shipped KD (knockdown) and palletized.
- \* E-Z Lock joints for easy installation.
- \* Precision milled expanded cellular PVC
- \* Low maintenance, rot proof, water proof, insect proof

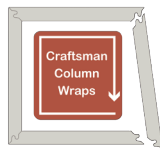

Craftsman are non-load bearing columns

The cap and base sets for tapered Craftsman Series columns consist of a platform and a molding. The platforms are factory cut in a "V" shape to allow easy installation around an existing load support. This "V" is reassembled using joster biscuits (included), PVC cement or polyurethane glue, and nails or screws. (As with all exterior products, non-corrosive fasteners must be used, such as double hot-dipped galvanized screws or nails). This same "V" cut construction is used for the top platform of Craftsman pedestals. Pedestals being used as newels may be ordered without the platform being "V" cut.

Edge view of "V" cut - shows where the joster biscuits install:

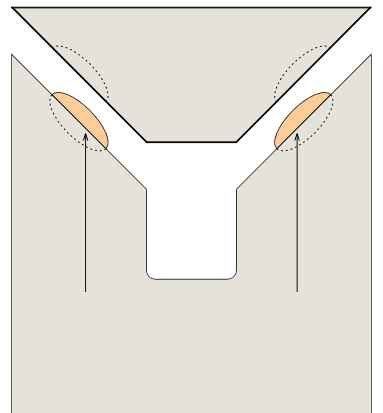

Plan view of "V" cut - shows joster biscuit recessed into edge

## POLY-CLASSIC® PVC CRAFTSMAN SERIES TAPERED CAP AND BASE

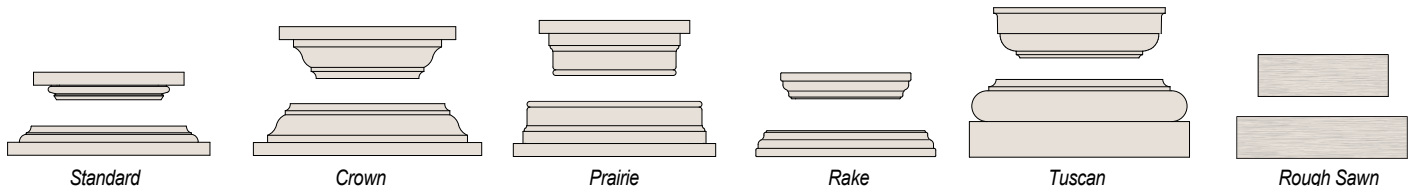

Standard

Crown

Prairie

Rake

Tuscan

Rough Sawn

# POLY-CLASSIC®

## CRAFTSMAN NON-TAPERED COLUMNS

### CRAFTSMAN SERIES

Craftsman Series column panels are not prone to the same environmental damage as real wood, like splitting or cracking. Their E-Z Lock joints will not separate due to disproportionate changes in panel dimensions common to wooden Craftsman columns. With two coats of acrylic latex paint, Poly-Classic® Craftsman Series columns will deliver years of service as promised by their limited lifetime warranty.



### PLAN TYPES

Craftsman Series are available in the following plan types. Please specify when you order. (Customer may specify actual returns, wall thicknesses, etc.) Plan O & N are available only as non-tapered.

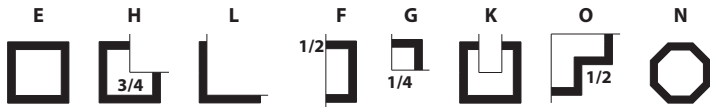

Designed to wrap around a structural support using our EZ-Lock joint design.

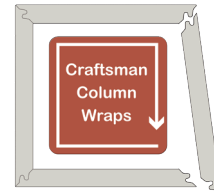

Craftsman  
Non-Tapered  
Square  
Smooth



Craftsman  
Non-Tapered  
Square  
Fluted



Craftsman  
Non-Tapered  
Square  
Raised Panels



Craftsman  
Non-Tapered  
Square  
Recessed Panels

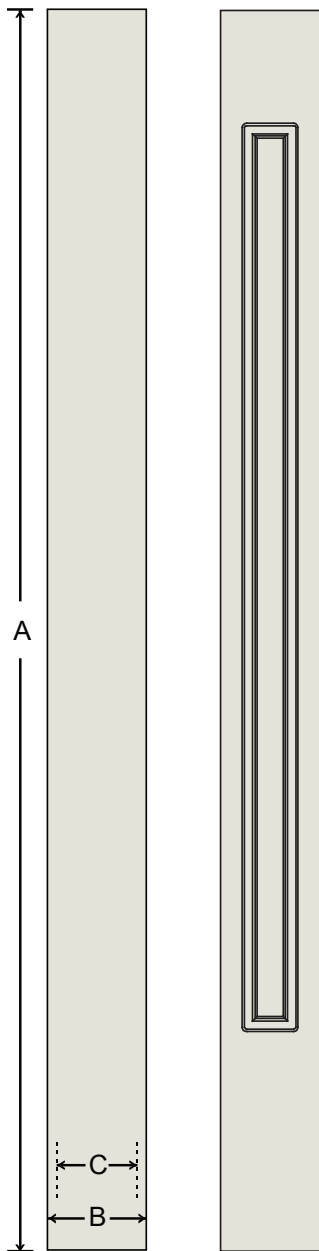

### POLY-CLASSIC® PVC CRAFTSMAN SERIES TAPERED COLUMN WRAP

Bottom Width	Width		Available Heights (A)												
	B	C	4'	5'	6'	8'	9'	10'	12'	14'	16'	18'	20'	22'	24'
6"	5 5/8"	4 3/8"	✓	✓	✓	✓	✓	✓	✓						
8"	7 5/8"	6 3/8"	✓	✓	✓	✓	✓	✓	✓						
10"	9 5/8"	8 3/8"	✓	✓	✓	✓	✓	✓	✓						
12"	11 5/8"	10 3/8"	✓	✓	✓	✓	✓	✓	✓						
14"	13 5/8"	12 3/8"				✓		✓	✓	✓					
16"	15 5/8"	14 3/8"				✓		✓	✓	✓	✓				
18"	17 5/8"	16 3/8"				✓		✓	✓	✓	✓	✓			
20"	19 5/8"	18 3/8"				✓		✓	✓	✓	✓	✓	✓		
22"	21 5/8"	20 3/8"				✓		✓	✓	✓	✓	✓	✓	✓	
24"	23 5/8"	22 3/8"				✓		✓	✓	✓	✓	✓	✓	✓	✓

### NEW! ROUGH SAWN PVC CRAFTSMAN SERIES NON-TAPERED COLUMN WRAP

Bottom Width	Width		Available Heights (A)							
	B	C	4'	5'	6'	8'	9'	10'	12'	
6"	5 5/8"	4 3/8"	✓	✓	✓	✓	✓	✓	✓	
8"	7 5/8"	6 3/8"	✓	✓	✓	✓	✓	✓	✓	
10"	9 5/8"	8 3/8"	✓	✓	✓	✓	✓	✓	✓	
12"	11 5/8"	10 3/8"	✓	✓	✓	✓	✓	✓	✓	

### CRAFTSMAN CAP AND BASE FOR NON-TAPERED COLUMN

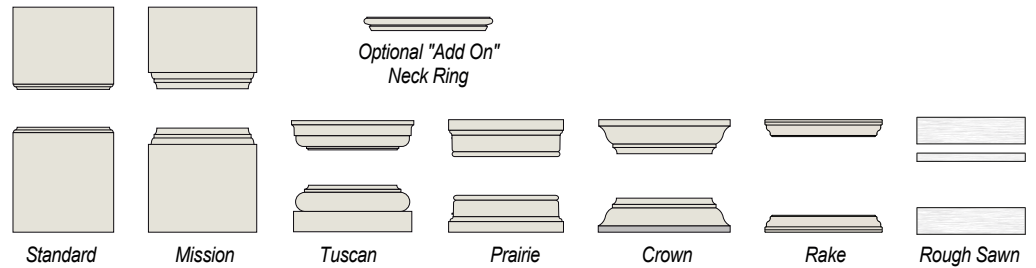

### CRAFTSMAN PEDESTAL

Bottom Width *	Available Heights							
	32"	36"	40"	42"	44"	48"	54"	60"
6"	✓	✓	✓	✓	✓	✓	✓	✓
8"	✓	✓	✓	✓	✓	✓	✓	✓
10"	✓	✓	✓	✓	✓	✓	✓	✓
12"	✓	✓	✓	✓	✓	✓	✓	✓
14"	✓	✓	✓	✓	✓	✓	✓	✓
16"	✓	✓	✓	✓	✓	✓	✓	✓
18"	✓	✓	✓	✓	✓	✓	✓	✓
20"	✓	✓	✓	✓	✓	✓	✓	✓
22"	✓	✓	✓	✓	✓	✓	✓	✓
24"	✓	✓	✓	✓	✓	✓	✓	✓
26"	✓	✓	✓	✓	✓	✓	✓	✓
28"	✓	✓	✓	✓	✓	✓	✓	✓
30"	✓	✓	✓	✓	✓	✓	✓	✓

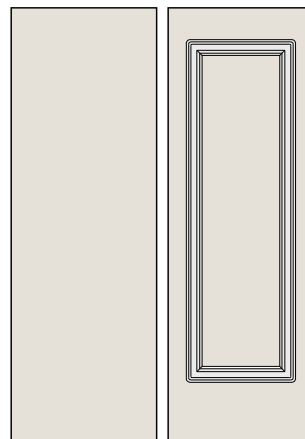

- Smooth
- Raised Panel
- Square Corner Raised Panel
- Recessed Panel

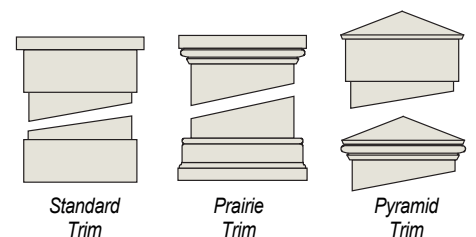

# TURNCRAFT WOOD COLUMNS

## ORNAMENTAL CAPITALS

Designed with crisp, true architectural detail, Turncraft ornamental capitals artfully capture natural themes and images. Made from composite materials that offer increased durability and low maintenance, ornamental capitals are available for round tapered Colonial columns. Visit [Turncraft.com](http://Turncraft.com) to see the large selection of ornamental capitals available.



We also offer  
**TURNCRAFT ARCHITECTURAL**  
custom wood columns  
on special order  
ask for quote

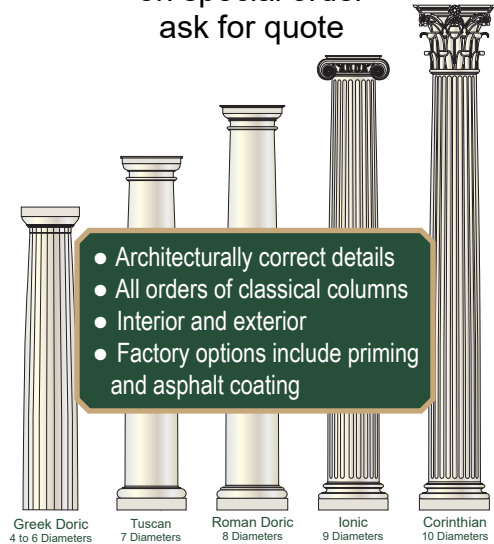

## PLAN TYPES

Colonial columns are available in the following plan types. Please specify when you order. Columns other than Plan Type A are not load bearing. Split or reassembled columns are not load bearing.

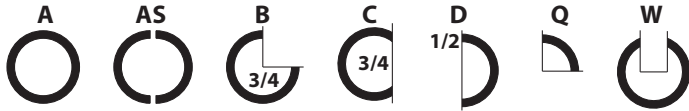

Wood Colonial  
Tapered  
Round  
Smooth



Wood Colonial  
Tapered  
Round  
Fluted

## COLONIAL WOOD ROUND TAPERED COLUMNS

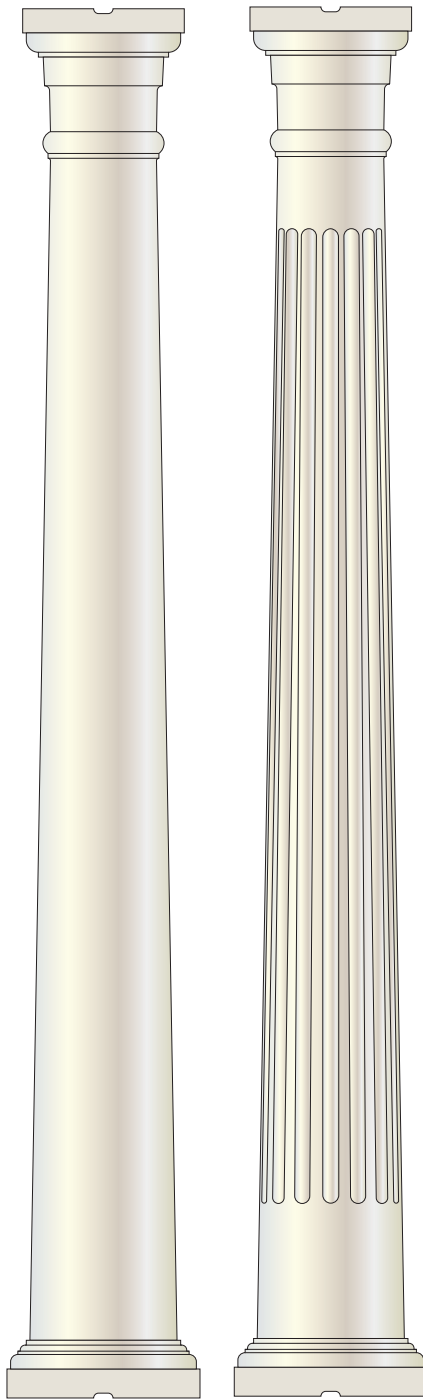

Colonial  
Polyurethane  
Cap and Base

Bottom Diameter	Heights										Capacity (pounds)
	6'	8'	10'	12'	14'	16'	18'	20'	22'	24'	
6"		✓	✓								2,095
8"		✓	✓								3,258
10"		✓	✓	✓							4,268
12"		✓	✓	✓	✓	✓					5,173
14"	✓	✓	✓	✓	✓	✓	✓	✓			6,808
16"	✓	✓	✓	✓	✓	✓	✓	✓			8,618
18"	✓	✓	✓	✓	✓	✓	✓	✓			10,624
20"		✓	✓	✓		✓	✓	✓			11,915
24"		✓	✓	✓		✓	✓	✓	✓	✓	20,974

## COLONIAL CAP AND BASES

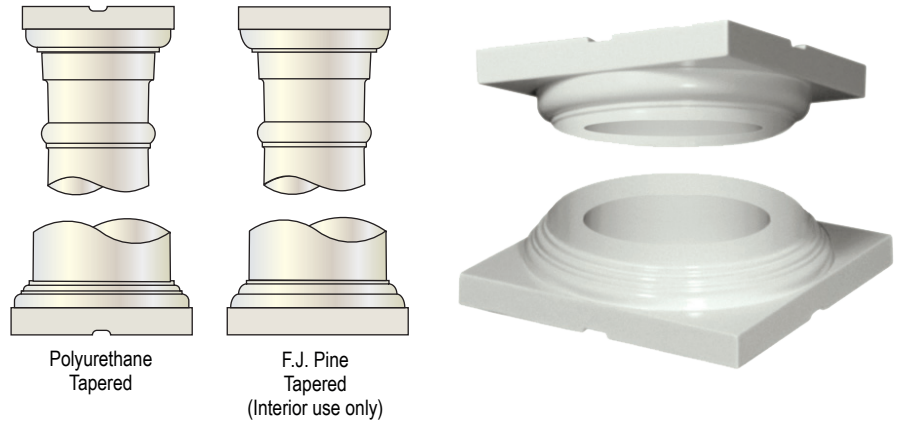

Polyurethane  
Tapered

F.J. Pine  
Tapered  
(Interior use only)

### Upon request:

Priming is applied in two coats, using a specially formulated primer developed exclusively for Turncraft. The column is sanded before each coat.

Asphalt coating of the shaft interior is applied to the bottom three feet of the shaft.

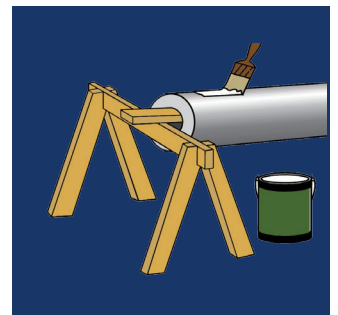

Turncraft Colonial columns begin with the milling of finger-jointed or solid staves to exacting dimensions. The staves are then assembled into a raw shaft using proprietary gluing process. Torque bands are wrapped around the shaft applying 90 to 100 pounds of pressure per square inch, transforming the individual staves into a single unit, ready for precision turning.

# TURNCRAFT WOOD SQUARE COLUMNS

LIMITED  
**LIFETIME**  
**COLUMN**  
**DEFENSE™**  
WARRANTY

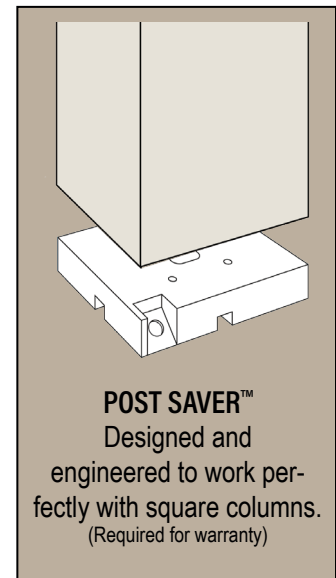
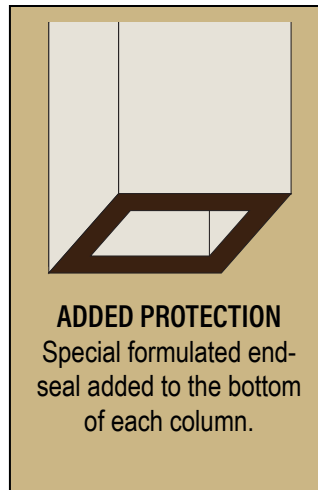

## COLUMN SHAFTS

Column Width x Height	Net Width	Load Capacity
4" x 8'	3 3/16"	1,000
4" x 9'	3 3/16"	1,000
4" x 10'	3 3/16"	1,000
5" x 8'	4 3/16"	3,000
5" x 9'	4 3/16"	3,000
5" x 10'	4 3/16"	3,000
6" x 8'	5 3/16"	5,800
6" x 9'	5 3/16"	5,800
6" x 10'	5 3/16"	5,800

## STANDARD CAP AND BASE (PVC)

Size	Width	Height
4"	4 5/8"	3"
5"	5 5/8"	3"
6"	6 5/8"	3"

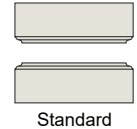

## CROWN CAP AND BASE (PVC)

Size	Width	Height
6"	11"	3"

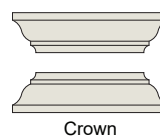

## MISSION CAP AND BASE (PVC)

Size	Width	Height
6"	7"	5 1/4"

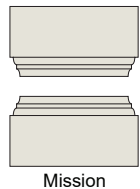

## PRAIRIE CAP AND BASE (PVC)

Size	Width	Height
6"	7 1/2"	3 1/4"

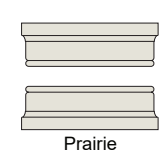

## TUSCAN CAP AND BASE (polyurethane)

Size	Width	Height
6"	7 3/8"	3 1/4"

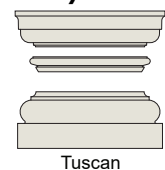

## POSTSAVER™ (required for warranty)

Size
4"
5"
6"



Wood Square Columns

# TURNCRAFT WOOD PORCH POSTS

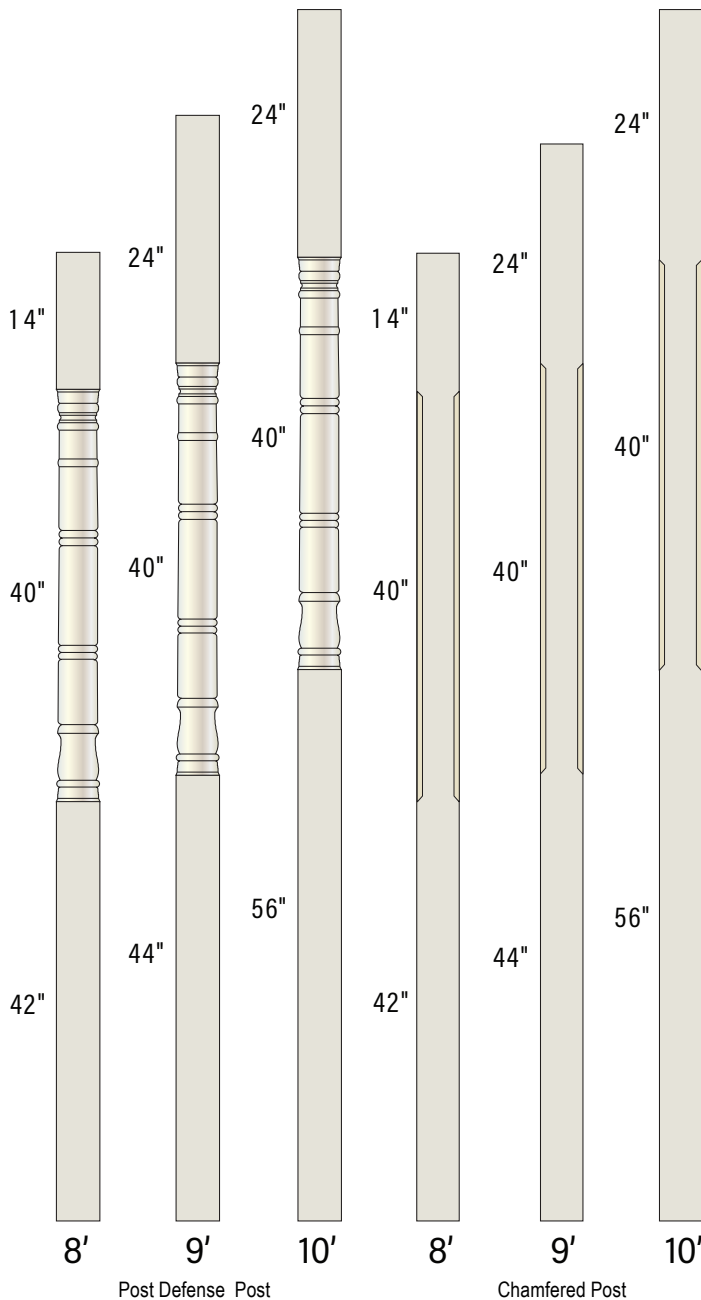

## POST DEFENSE PORCH POSTS

Column Width x Height	Base Height	Load Capacity
4" x 8'	42"	1,000
4" x 9'	44"	1,000
4" x 10'	56"	1,000
5" x 8'	42"	3,000
5" x 9'	44"	3,000
5" x 10'	56"	3,000
6" x 8'	42"	5,800
6" x 9'	44"	5,800
6" x 10'	56"	5,800

## CHAMFERED PORCH POSTS

Column Width x Height	Base Height	Load Capacity
5" x 8'	42"	3,000
5" x 9'	44"	3,000
5" x 10'	56"	3,000
6" x 8'	42"	5,800
6" x 9'	44"	5,800
6" x 10'	56"	5,800

## POSTSAVER™ (required for warranty)

Size
4"
5"
6"

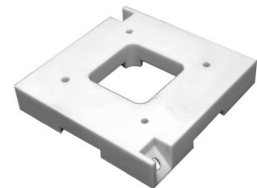

## POST TRIM KIT

Size
4"
5"
6"



The new PVC porch post Trim kit is designed to wrap around the porch post and mounting (PostSaver™, plinth, etc.) for a finished look.



Turncraft.com

PO Box 2429  
White City, Oregon 97503  
T 541 826 2911  
T 800-423-3311  
info@turncraft.com



Turncraft Column Builder App Available in App Store



find us on:



@2024 Turncraft. All rights reserved. Turncraft and Poly-Classic® are registered trademarks of Cascade Wood Products, Inc. DuraGlass™, and Post Defense are trademarks of Cascade Wood Products, Inc. All other trademarks mentioned herein are the property of their respective owners. Information and specifications in this catalog are subject to change without notice.

www.turncraft.com | (800) 423-3311

