



Crown[®]
Heritage



3404 Balusters
& 4097 Box Newel

TABLE OF CONTENTS

Quick Reference Guide	2-3	Box Newels	45-52
Handcrafted Forged Iron	3-22	Stain Grade Box Newels	45-46
Forged Iron Finish Options	4	Primed Box Newels	45-38
Forged Iron Collections	5-20	Design Your Own Box Newels	49-50
Palermo	5-6	Box Newel Accessories	51-52
Hollow Knee-Wall Balusters	7	Sierra	53-54
Extra Large	8	Williamsburg	55
Sicily	9-10	Jefferson	56
Milan	11-12	1800s	57-58
Vicenza	13-14	Carolina	59-60
Marsala	15-16	Hampton	61-62
Florence	17-18	Colonial	63-64
Forma	19-20	Craftsman	65-66
Iron Components	21-22	Custom Products	67-70
Euro-Slim Tubes	23-24	Fittings & Components	71-79
Cable and Aluminum Railings	25-40	Fittings	71-72
Flex Cable	25-28	Handrail and Shoerails	73
102 Series	29-30	Wall Rails, Rail Accessories and Rosettes	74
224 Series	31-32	Treads and Risers	75-76
200 Surface Mount	33-34	Starting Steps	77
250 Surface Mount	35-36	False Tread Kits, Mouldings, Brackets and Skirtboard	78
200 Fascia Mount	37-38	Accessories & Hardware	79
250 Rail Components	39-40	Stair Part Terms Illustrated & Defined .	81-82
Open Rise Stair Systems	41-42	Architecturally Correct Stairways	83-84
Spiral Stairways	43	Over-the-Post Take-off Guide	83
Hardwood Collections	44-66	Post-to-Post Take-off Guide	84
		Index	85-88

GEARScan is a patent pending sales tool by Crown Heritage. For more information contact your local Crown Heritage Representation.



PALERMO COLLECTION

Pages 5-6



XL HOLLOW BALUSTERS

Page 8

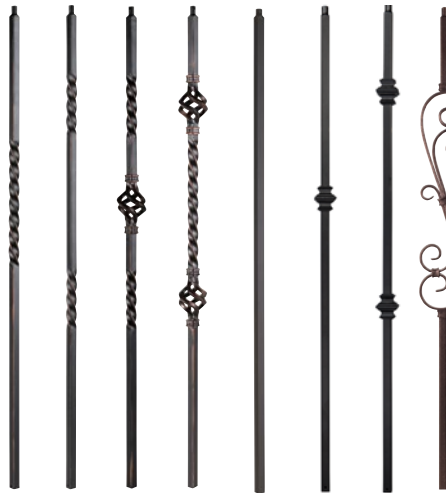

SICILY COLLECTION

Pages 9-10



MILAN COLLECTION

Page 11



WOOD BALUSTERS

SIERRA COLLECTION

Page 53

WILLIAMSBURG COLLECTION

Page 55

JEFFERSON COLLECTION

Page 56

1800s COLLECTION

Page 57

CAROLINA COLLECTION

Page 59



NEWELS

SIERRA COLLECTION

Page 54

WILLIAMSBURG COLLECTION

Page 55

JEFFERSON COLLECTION

Page 56

1800s COLLECTION

Page 58

CAROLINA COLLECTION

Page 60

HAMPTON COLLECTION

Page 62

COLONIAL COLLECTION

Page 64



VICENZA
COLLECTION

Pages 13-14



MARSALA
COLLECTION

Page 15



ROMA
COLLECTION

Page 16



FLORENCE
COLLECTION

Pages 17-18

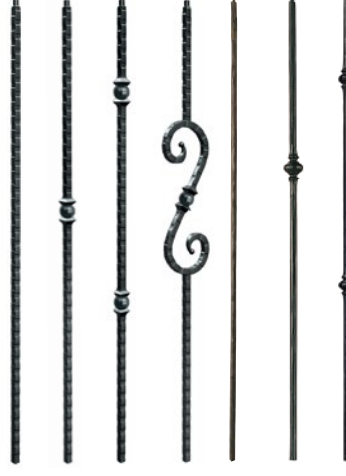

FORMA
COLLECTION

Page 19-20

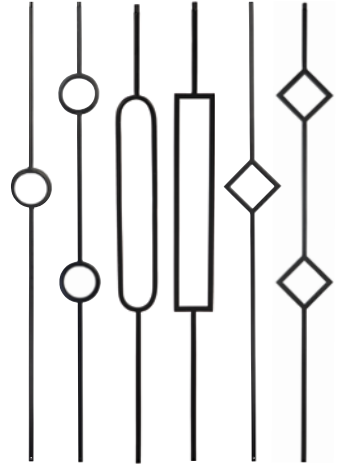

HAMPTON
COLLECTION

Page 61



COLONIAL
COLLECTION

Page 63

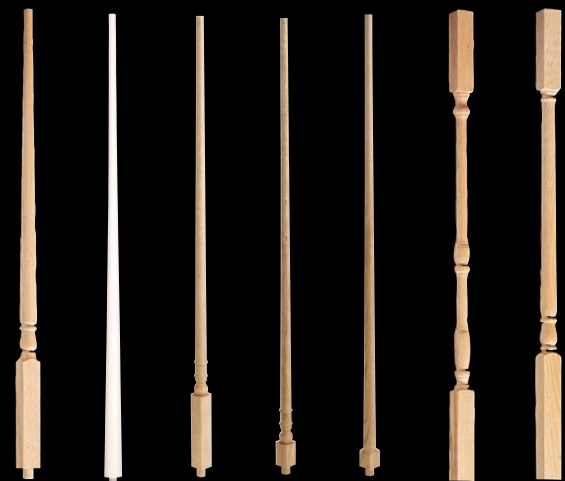

CRAFTSMAN
COLLECTION

Page 65



CRAFTSMAN
COLLECTION

Page 66



STAIN GRADE AND
PRIMED BOX NEWELS

Page 45-47



HANDCRAFTED IRON BALUSTERS



*Pictured here with Satin Nickel balusters
3700, 3701 and 4086 newel.*

HANDCRAFTED IRON BALUSTERS

Available in nominal sizes of 12mm = 1/2", 14mm = 9/16", 19mm = 3/4" and 30mm = 1-3/16"

Satin Black



Satin Nickel



Rubbed Copper



Oil Rubbed Bronze



Ash Gray



AVAILABLE IN
FIVE COLOR FINISHES

PALERMO COLLECTION





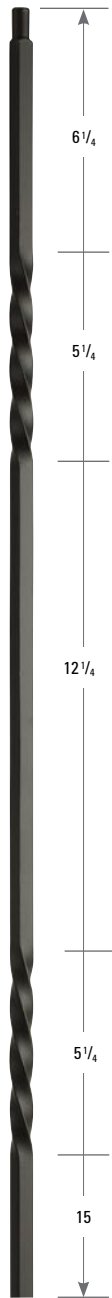

1101 (Solid)
3101 (Hollow)
12mm

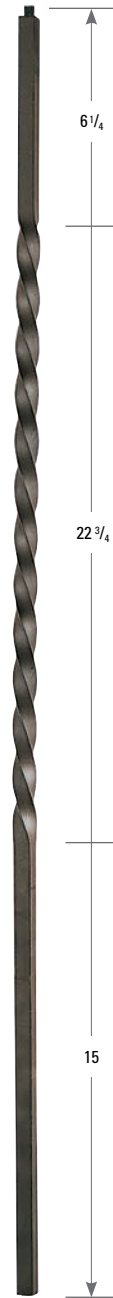

1102 (Solid)
3102 (Hollow)
12mm



1103 (Solid)
12mm

Item Number	 Satin Black	 Satin Nickel	 Rubbed Copper	 Oil Rubbed Bronze
1101	•			
3101	•	•	•	•
1102	•			
3102	•	•	•	•
1103	•			
1121	•			
3121	•	•	•	•
1122	•			
3122	•	•	•	•
1190	•			

PALERMO COLLECTION

Note: Not all images are to scale. | All dimensions in inches unless specified.

NEWELS

3/4" is included in the overall height for the pin tops on the balusters.

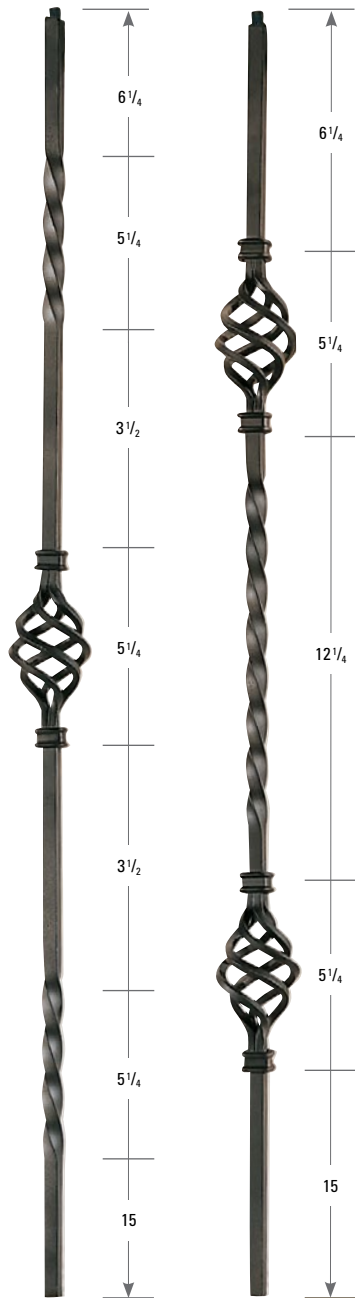

1121 (Solid)
3121 (Hollow)
12mm

1122 (Solid)
3122 (Hollow)
12mm



1190 (Solid)
30mm



1190
Newel
detail



Pictured here with balusters 3101 and 3102.



36" Iron Balusters

For your convenience 3101, 3102, 3121, 3122 and 3700 profiles are also available in 36" lengths. Ideal for balconies... just unwrap, install and go! Available in Satin Black.





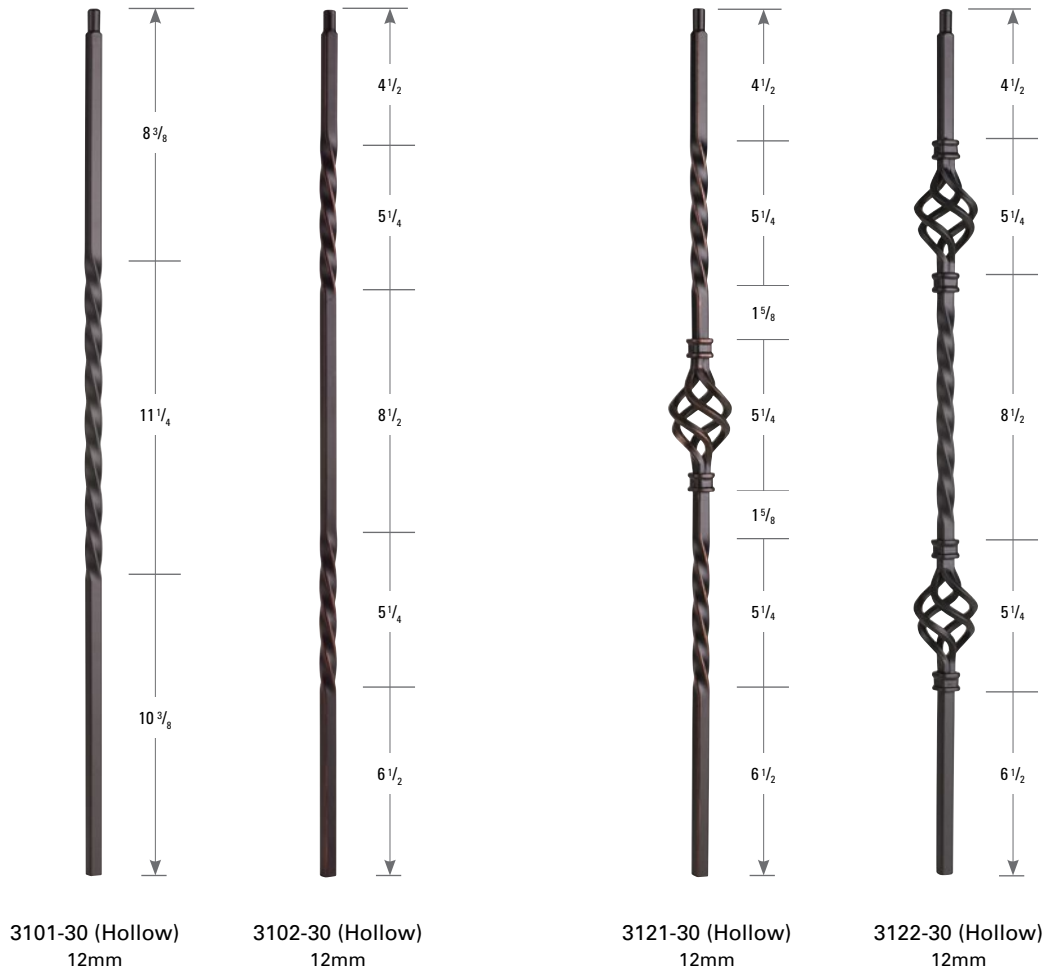

KNEE WALL BALUSTERS



30" balusters are designed with tighter dimensions *specifically* for knee walls.

30" balusters are perfect for creating great visual style and alignment in a knee wall installation, while 44" balusters complement traditional landing heights.

Item Number	 Satin Black	 Satin Nickel	 Rubbed Copper	 Oil Rubbed Bronze
3101	•		•	
3102	•		•	
3121	•		•	
3122	•		•	

EXTRA LARGE HOLLOW BALUSTERS

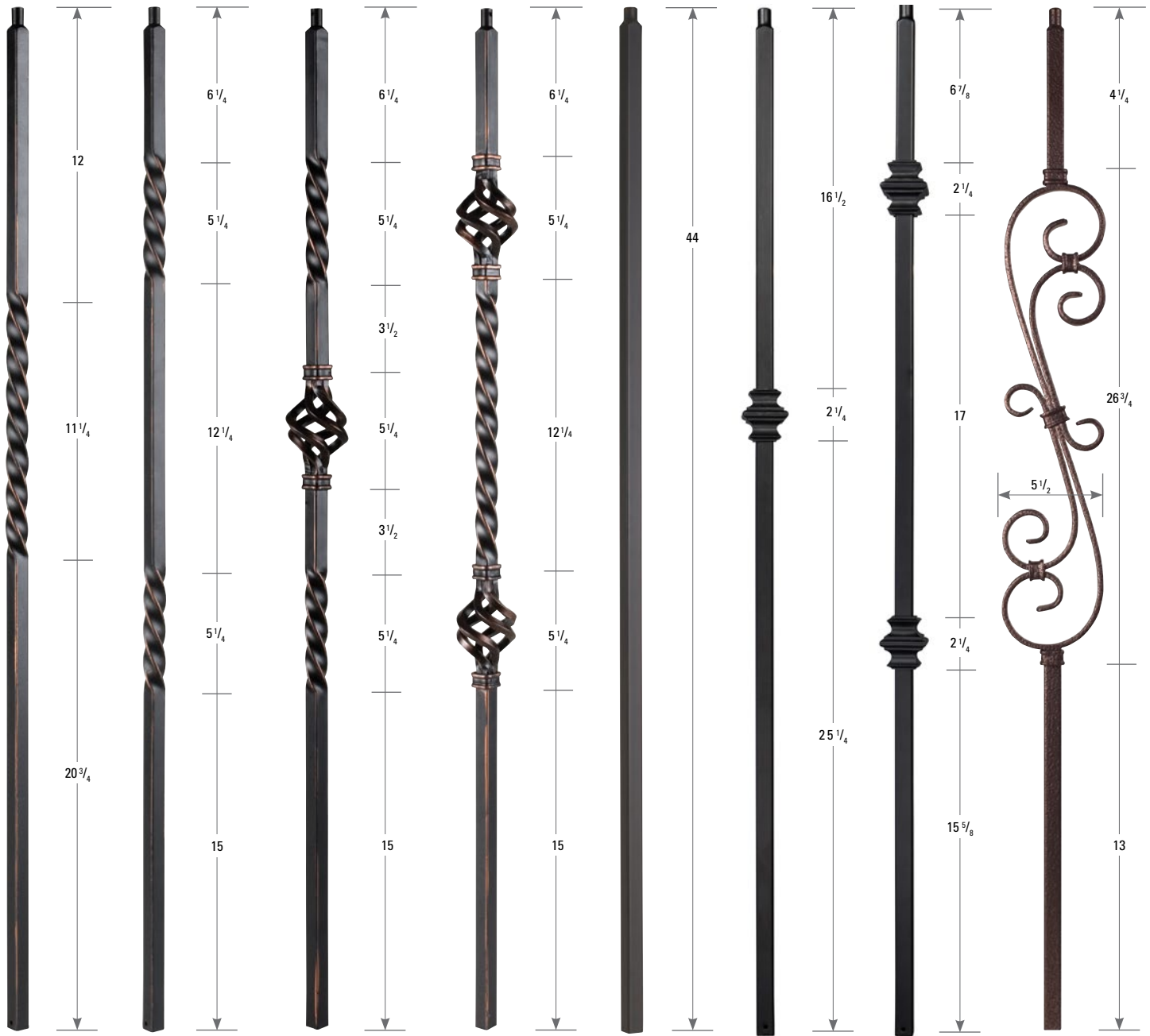

2101 (Hollow)
19mm

2102 (Hollow)
19mm

2121 (Hollow)
19mm

2122 (Hollow)
19mm

2700 (Hollow)
19mm

2701 (Hollow)
19mm

2702 (Hollow)
19mm

2708 (Hollow)
19mm

Item Number	Satin Black	Satin Nickel	Rubbed Copper	Oil Rubbed Bronze
2101	•		•	
2102	•		•	
2121	•		•	
2122	•		•	
2700	•		•	
2701	•		•	
2702	•		•	
2708	•		•	



SICILY COLLECTION

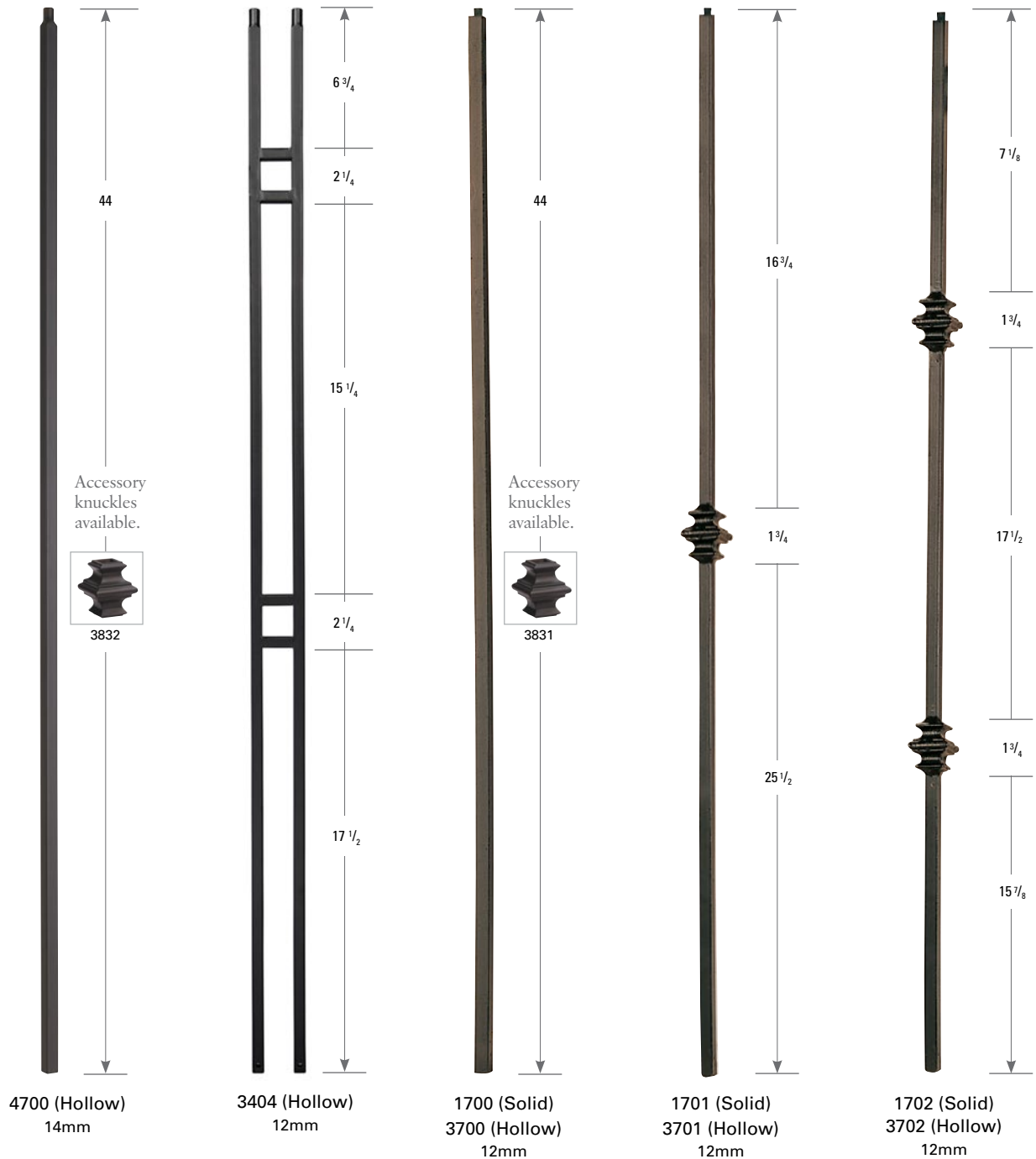

Item Number	Satin Black	Satin Nickel	Rubbed Copper	Oil Rubbed Bronze	Ash Gray
4700	•		•		
3404	•				
1700	•				
3700	•	•	•	•	•
1701	•				
3701	•	•	•	•	
1702	•				
3702	•	•	•	•	

SICILY COLLECTION

Note: Not all images are to scale. | All dimensions in inches unless specified.

3/4" is included in the overall height for the pin tops on the balusters.





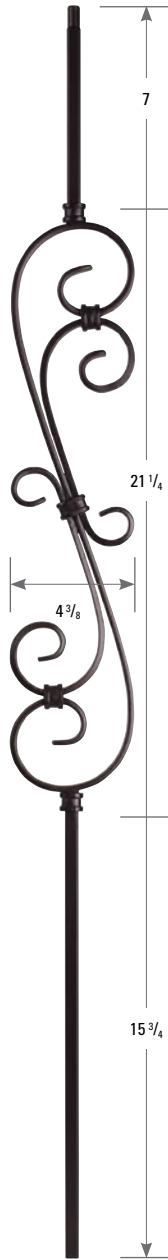

1707 (Solid)
14mm

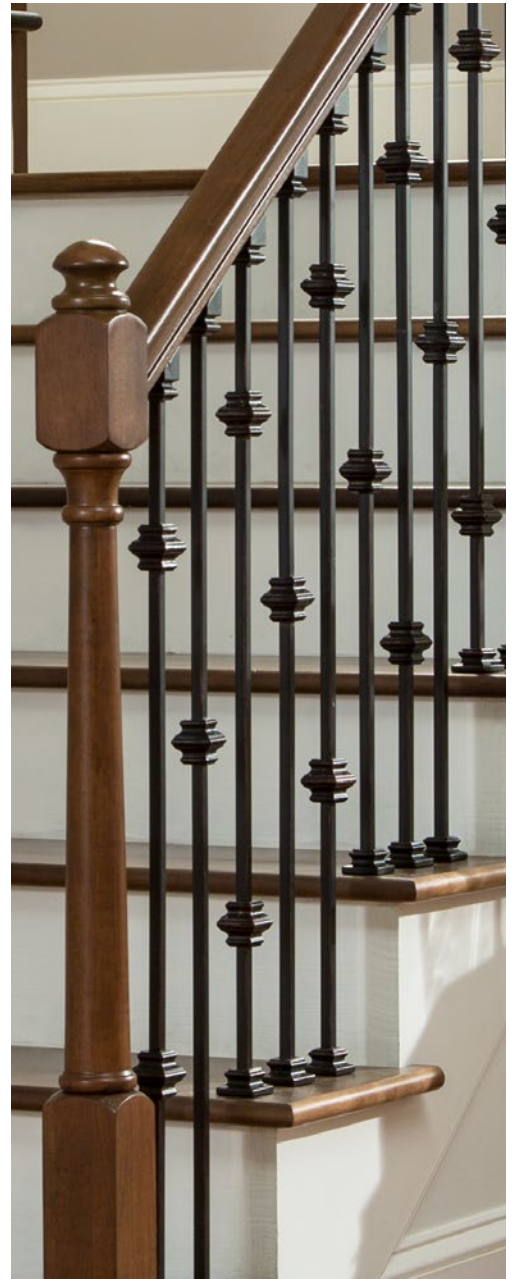

3708 (Hollow)
12mm



*Pictured here with
3701 & 3702 balusters.*

Item Number	 Satin Black	 Satin Nickel	 Rubbed Copper	 Oil Rubbed Bronze
1707	•			
3708	•		•	•



MILAN COLLECTION



1000 (Solid)
14mm

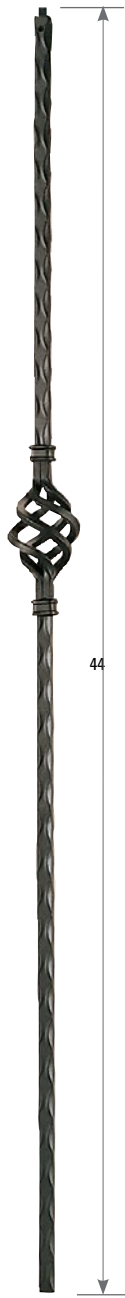

1001 (Solid)
14mm

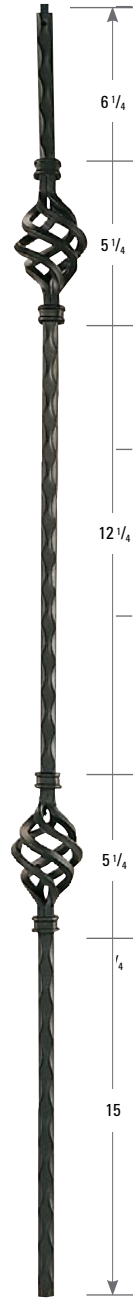





1002 (Solid)
14mm

NEWELS



1090 (Solid)
30mm

Item Number	 Satin Black	 Satin Nickel	 Rubbed Copper	 Oil Rubbed Bronze
1000	•		•	
1001	•		•	
1002	•		•	
1090	•			

MILAN COLLECTION

*Note: Not all images are to scale. | All dimensions in inches unless specified.
3/4" is included in the overall height for
the pin tops on the balusters.*



VICENZA COLLECTION

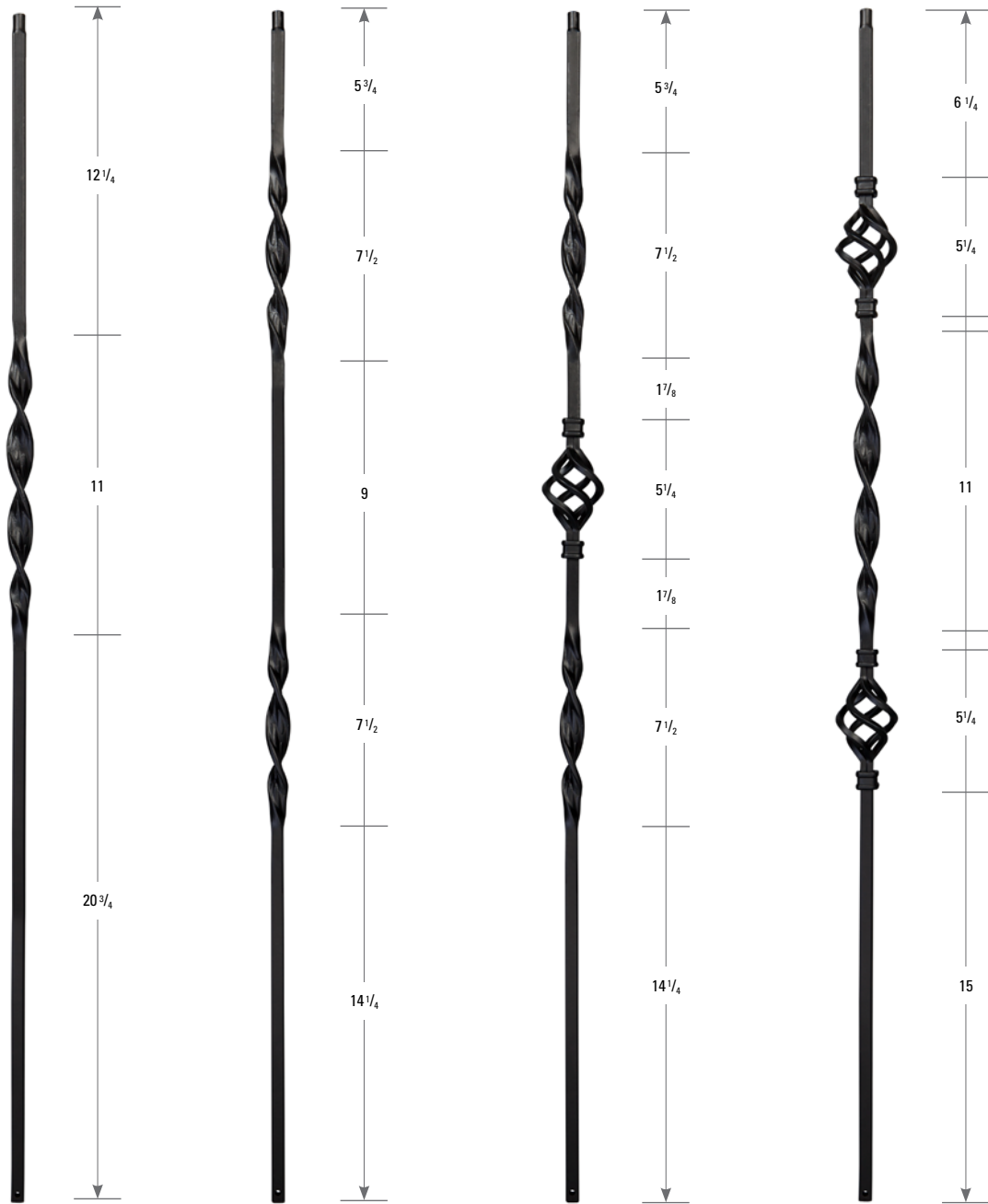

3301 (Hollow)
12mm

3302 (Hollow)
12mm

3321 (Hollow)
12mm

3322 (Hollow)
12mm

Item Number	Satin Black	Satin Nickel	Rubbed Copper	Oil Rubbed Bronze
3301	•			
3302	•			
3321	•			
3322	•			

VICENZA COLLECTION

Note: Not all images are to scale. | All dimensions in inches unless specified.

3/4" is included in the overall height for the pin tops on the balusters.



Pictured here with 1301 & 1302 balusters and 3821 & 3811 shoes.



MARSALA COLLECTION

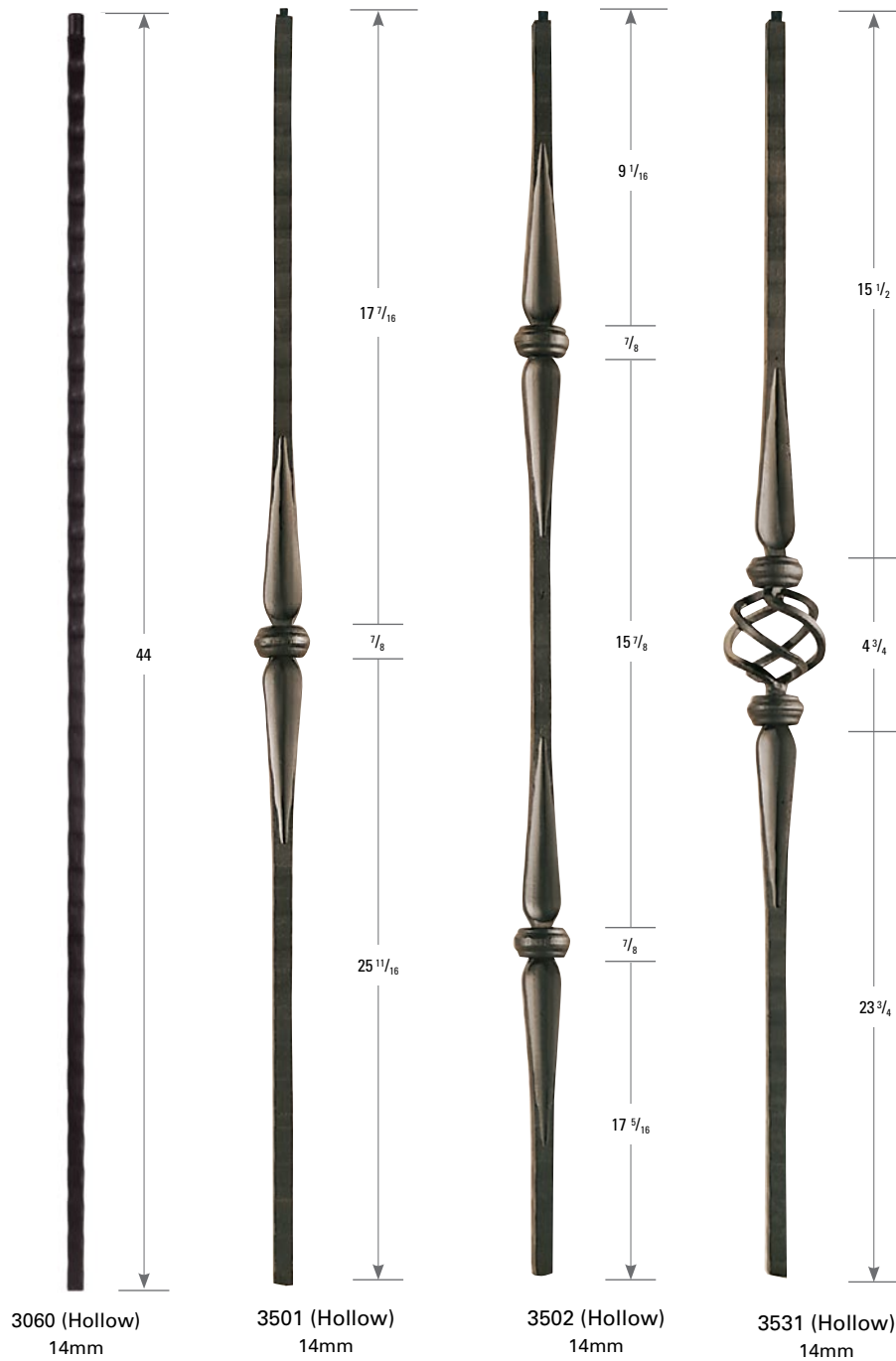

Pictured here with 1501 & 1502 balusters and 6210 handrail.

Item Number	Satin Black	Satin Nickel	Rubbed Copper	Oil Rubbed Bronze
3060	•		•	•
3501	•		•	•
3502	•		•	•
3531	•		•	•

ROMA COLLECTION

Note: Not all images are to scale. | All dimensions in inches unless specified.

3/4" is included in the overall height for the pin tops on the balusters.

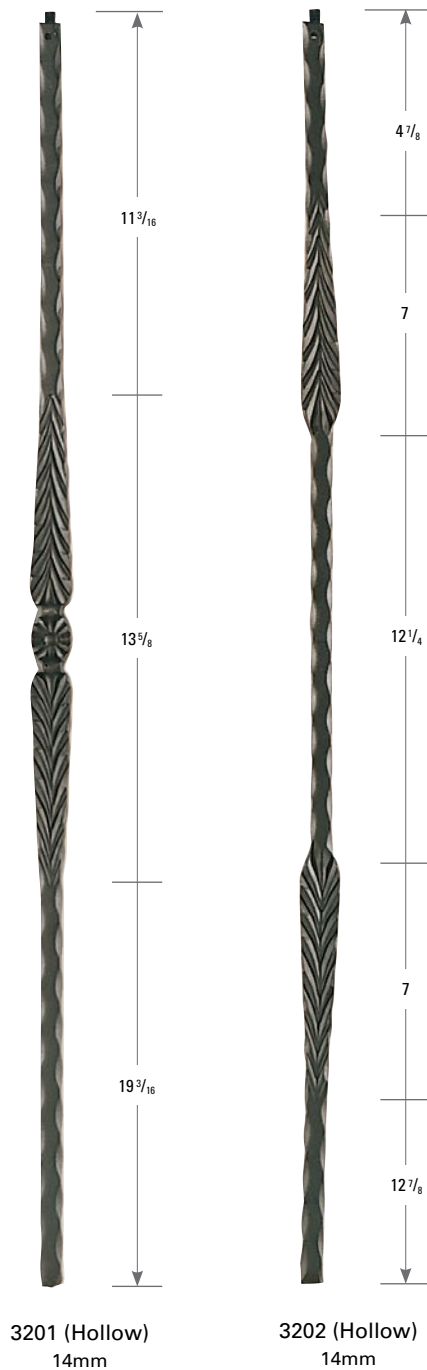

Item Number	Satin Black	Satin Nickel	Rubbed Copper	Oil Rubbed Bronze
3201	•			
3202	•			



FLORENCE COLLECTION

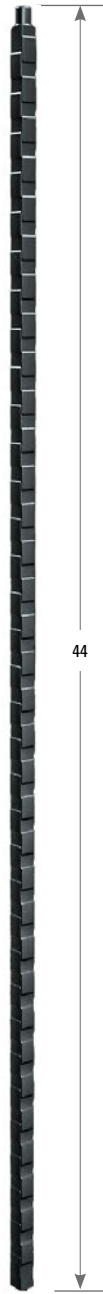

1060 (Solid)
14mm

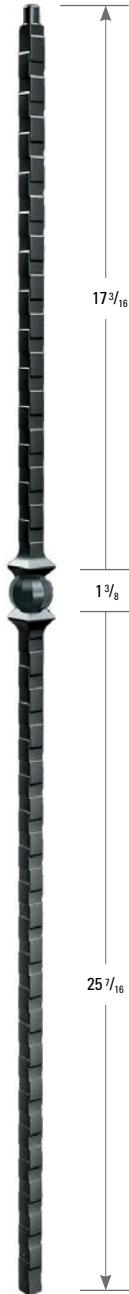



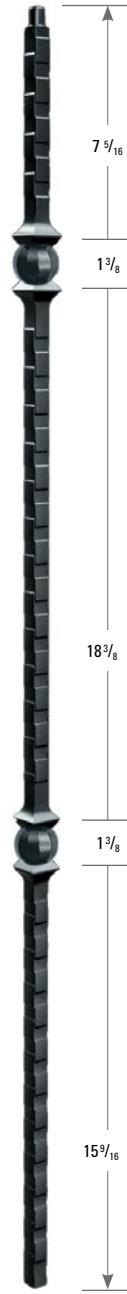

1061 (Solid)
14mm

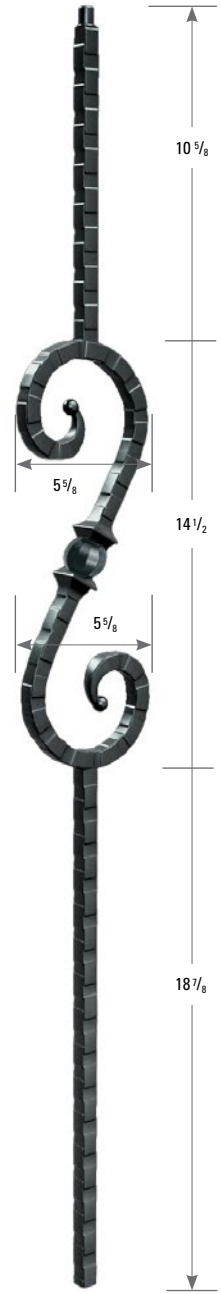

1062 (Solid)
14mm



1068 (Solid)
14mm

Item Number	 Satin Black	 Satin Nickel	 Rubbed Copper	 Oil Rubbed Bronze
1060	•		•	
1061	•		•	
1062	•		•	
1068	•			

ROUND BALUSTERS

Note: Not all images are to scale. | All dimensions in inches unless specified.

3/4" is included in the overall height for the pin tops on the balusters.

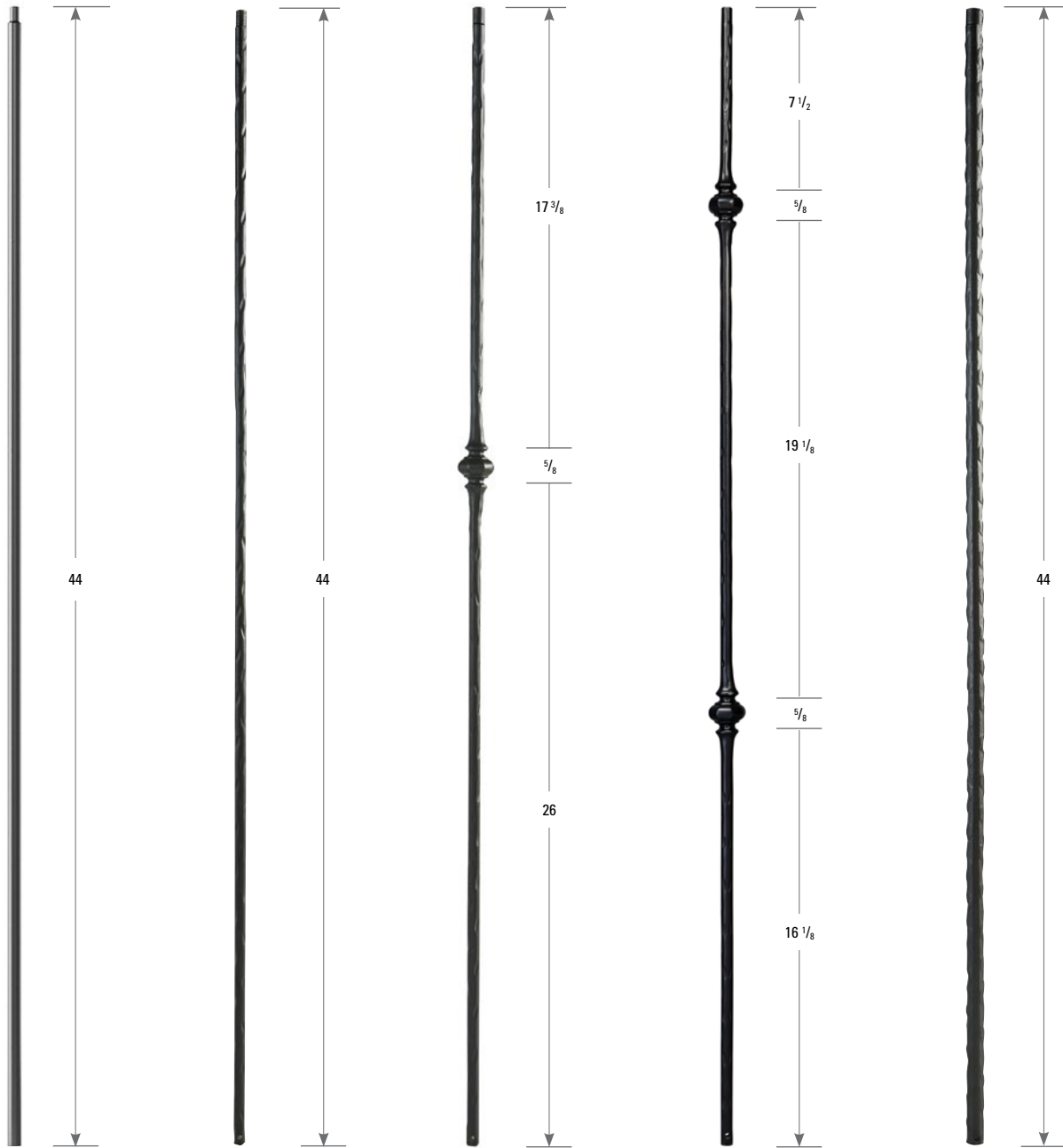

3600 (Hollow)
12mm
Smooth Round

1070 (Solid)
12mm
Hammered
Round

1071 (Solid)
12mm
Hammered Round

1072 (Solid)
12mm
Hammered Round

1074 (Solid)
16mm
Hammered Round

Item Number	Satin Black
3600	●
1070	●
1071	●
1072	●
1074	●

Hammered Round Balusters

NOTE: 1070, 1071, 1072 and 1074 are hammered.



FORMA COLLECTION

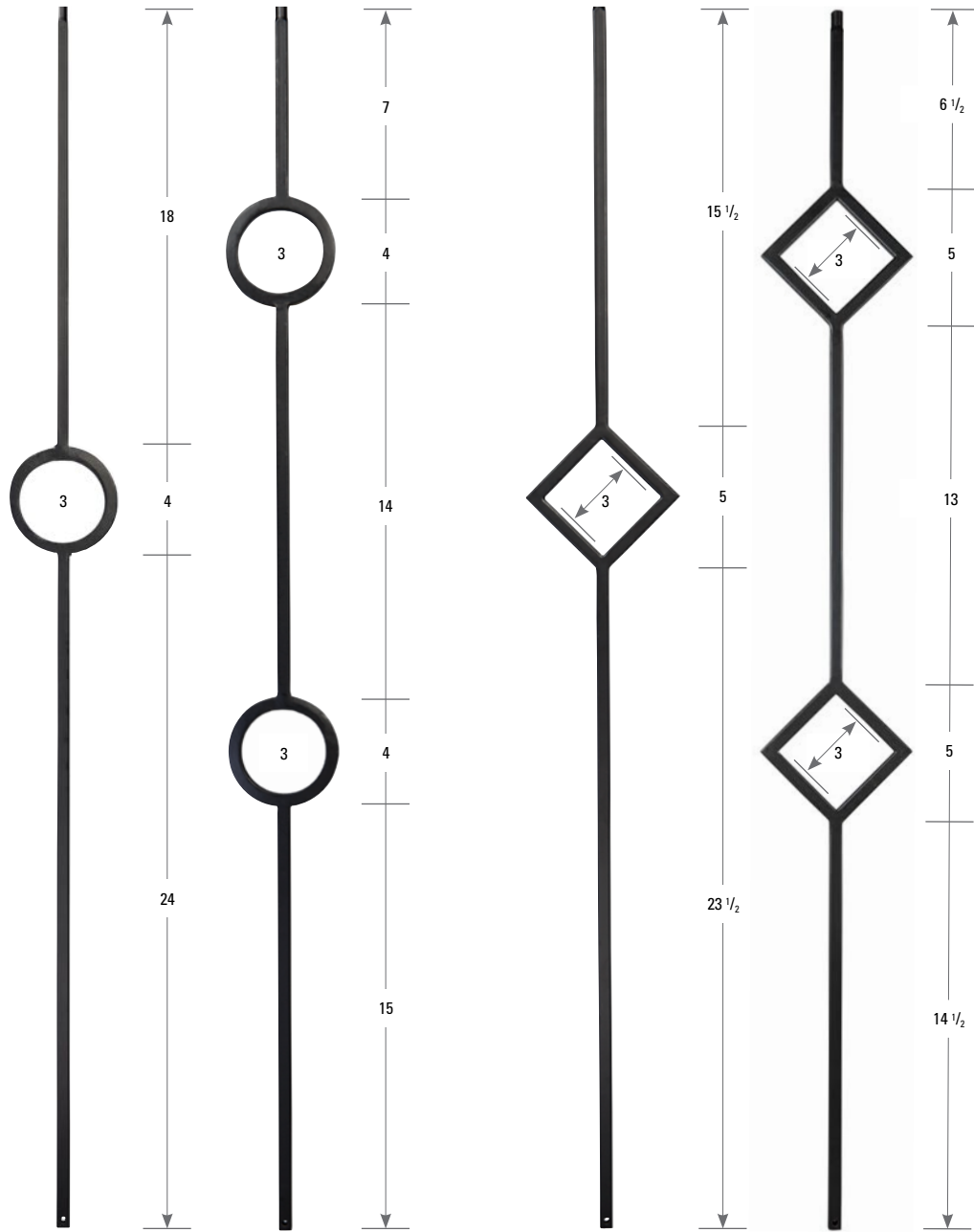

3401 (Hollow)
12mm

3402 (Hollow)
12mm

3406 (Hollow)
12mm

3407 (Hollow)
12mm

Item Number	Satin Black	Satin Nickel	Rubbed Copper	Oil Rubbed Bronze
3401	•			
3402	•			
3406	•			
3407	•			
3408	•			
3409	•			
3410	•			
3790	•			

Note: Not all images are to scale. | All dimensions in inches unless specified.

3/4" is included in the overall height for the pin tops on the balusters.

NEWELS

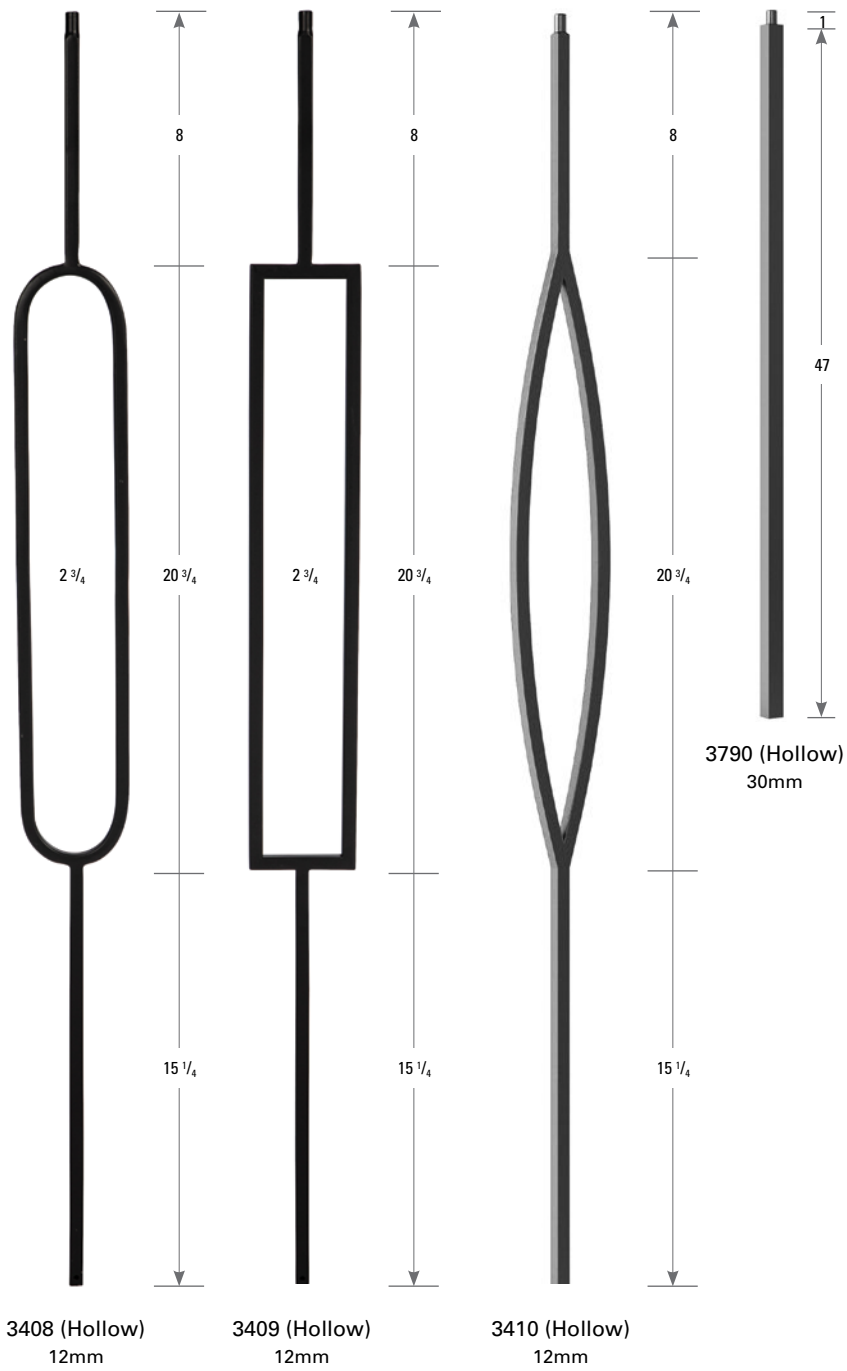

Pictured here with 3700 & 3409 balusters.

IRON COMPONENTS

SHOES



3811
(12mm)

3812
(14mm)

2811
(19mm)



3816
(12mm)
FB/RC

3817
(14mm)
FB/RC



3821
(12mm)

3822
(14mm)

2821
(19mm)



3910
(12mm)



3911
(12mm)

STRAIGHT BAR ACCESSORIES



1866
(12mm)



3831
(12mm)
FB/RC/RB

3832
(14mm)
FB/RC

NEWEL HARDWARE



1843
Newel
installation
hardware.



1844
(30mm)



3844
(30mm)
Low Profile
Newel Shoe

HARDWARE

3037
2-Pack Epoxy tips
for 3039



3039
Epoxy Refill
Used with 3038 gun
(Includes 2 tips)



3038
Epoxy Gun



3137
6-Pack Epoxy Tips
Use with 3139



3139
15 Minute Epoxy
Works in standard
caulking gun
(Tips not included)





*Pictured with 3410 and 3911
Low Profile baluster shoe*

EURO-SLIM TUBES

HOLLOW ROUND
TUBES FEATURE
A THIN PROFILE
FOR AN ELEGANT
FINISH

BLACK
(ITEM #9058BK)

STAINLESS
(ITEM #9058SS)

*Pictured here with 4000 newel
4113 intermediate post and
6002 handrail.*



CONTEMPORARY

TOUCH TO A TRADITIONAL DESIGN



SLIM DESIGN PROVIDES
AN ALTERNATIVE TO OTHER
HORIZONTAL OPTIONS



MULTIPLE APPLICATIONS FOR
HORIZONTAL AND A VERTICAL
CONTEMPORARY LOOK

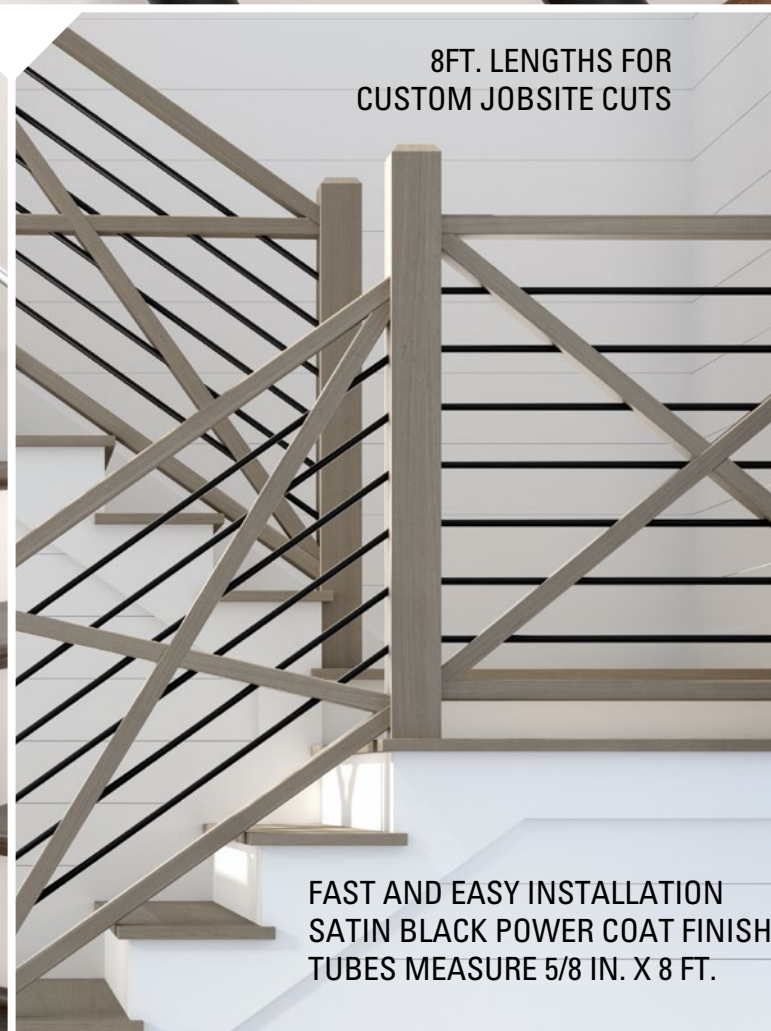

8FT. LENGTHS FOR
CUSTOM JOBSITE CUTS

FAST AND EASY INSTALLATION
SATIN BLACK POWER COAT FINISH
TUBES MEASURE 5/8 IN. X 8 FT.

FLEX CLASSIC SERIES

INSIDE MOUNT SYSTEM



FITTINGS & TOOLS

Available in level spans or stairways. Each section requires at least one tension fitting. All fittings available in single or 10 packs.



Level Tension End
(#3058)



Level Non-Tension
(#3059)



Stair Tension
(#3056)



Stair
Non-Tension
End
(#3057)



Cable Cutters
(#3068)



Cable Spools available in:
100' (#4909100)
500' (#4909500)

Note: Cable fittings not shown at actual size.

FLEX FX SERIES

INSIDE MOUNT SYSTEM



FITTINGS & TOOLS

Use for level or stair applications.
Each section requires at least one tension fitting.
All fittings are available in single or 10 packs.



Tension Fitting
(#9558)



Non-Tension Fitting
(#9559)



Cable Cutters
(#3068)



Cable Spools available in:
100' (#4909100)
500' (#4909500)



Installation Kit
(#3053FLX)

Includes:
Release Keys (#3066)
(Also Sold Separately)
Wrenches
Drill Bits

CABLE-102 SERIES

OUTSIDE MOUNT SYSTEM



3" THREADED STUD COMPLETELY CONCEALED INSIDE THE POST



- Budget friendly option
- Traditional stud system design
- All caps are included in kit
- Includes stud bushing to speed installation
- Cable kit lengths available in 5', 10', 15', 20', 30', 40' and 50'.



102 EXPRESS MOUNT OPTION

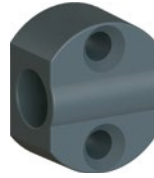

End Bracket
(#490102XEBK)
20pk



Intermediate Bracket
(#490102XIBK)
10pk



Corner Bracket
(#490102XCBK)
10pk

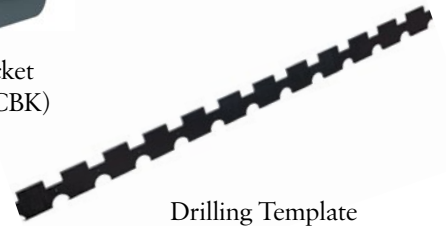

Drilling Template
(#4900912)



102 / 224 Installation Kit
(#3053-224)

Includes:
Cut-off Wheel
Cable Gripping Tool
Release Keys (#3066)
(Also Sold Separately)
Wrenches
Drill Bits

- Retrofits on new or existing wood posts, both level and stair applications
- Save Time- Brackets install on the exterior face of the post, no drilling through posts required
- Save Money- Ability to turn a single corner post with a continous run cuts down number of cable kits
- Patent pending design backed by a Limited Lifetime Warranty

CABLE-224 SERIES

OUTSIDE MOUNT SYSTEM



FITTINGS & TOOLS

CABLE DESIGNED SPECIFICALLY FOR
2-3/8" METAL POST



- Low-profile end caps
- Simple tensioning using only a hex key
- Kit includes washers for both wood and metal installations
- Cable kit lengths available in 5', 10', 15', 20', 30', 40', 50' and 60'



102 / 224
Installation Kit
(#3053-224)
Includes:
Cut-off Wheel
Cable Gripping Tool
Release Keys
(#3066)
(Also Sold Separately)
Wrenches
Drill Bits



ALUMINUM SURFACE MOUNT SYSTEMS OVER THE POST



ALUMINUM OPTIONS

Aluminum is stocked in black, silver, bronze and white

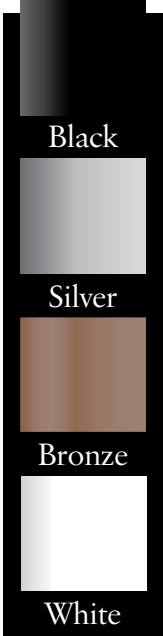

200 Handrail Over-the-Post
(Available in 14' and 10' sections depending on color)

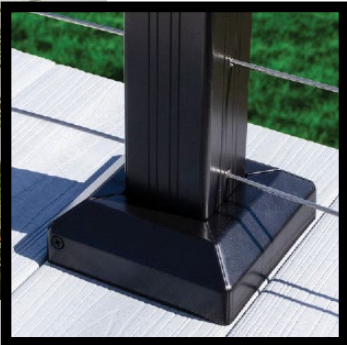

Surface Mount Base Plate Trim Kit (#0120)
Optional kit to cover base plate



400 Handrail Over-the-Post
Allows for adding a custom decking board as top

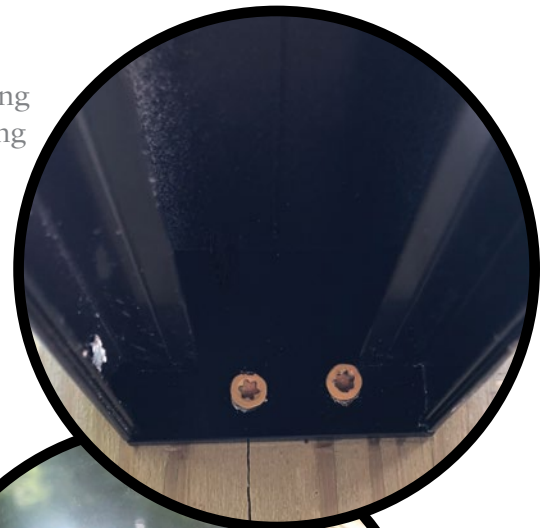

DID YOU KNOW?

A 200 profile rail can be attached to a wood post using an end cap (#0112).



ALUMINUM-250 SURFACE MOUNT POST TO POST





RAIL PROFILES



250 Handrail
Post-to-Post
(Available in 20' sections)

Aluminum is
stocked in
black only.

Silver,
Bronze and
White are
special order



Connector Block (#0118)
Attach a 250 rail to post.



Aluminum fascia mount stocked in black only

Black



200 Handrail Over-the-Post
(Available in 14' and 10' sections depending on color)



400 Handrail Over-the-Post
Allows for adding a custom decking board as top



Fascia Bracket (#0415)
Required for fascia installation



Double Post Corner Fascia Bracket (#0423)
Required for fascia installation



ALUMINUM-200 FASCIA MOUNT OVER THE POST



STAIR COMPONENTS FOR 250 RAILING



Connector Block - Stairs
(#011812)

Attach a 250 rail to post.
12" block to easily cut
angles. Makes up to
10 connections.



Post Fitting
(#0412)

Continuous run over
intermediate post
using a 250 rail.



Post Cap
(#0410)







OPEN RISE STAIR SYSTEM

CONFIGURATION OPTIONS

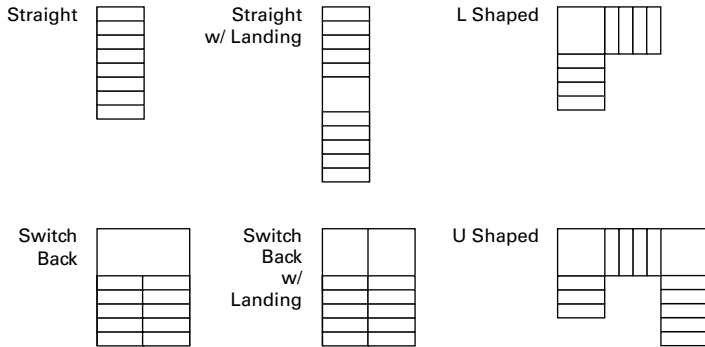

COLOR OPTIONS

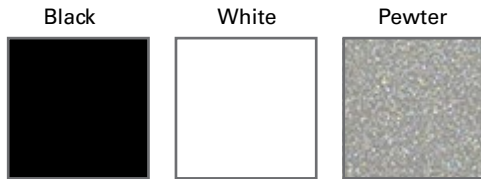

TREAD OPTIONS



Post Fitting (Item# 0421)
For attaching a wood handrail continuous over posts.



Paris



Seattle



Tokyo

Check with local building codes concerning open rise stairs. Some systems may require thicker treads

SPIRAL STAIRWAYS

Crown Heritage Spirals are designed to your specifications and completely assembled at the factory with a custom formed handrail, then re-packaged for easy assembly at the job site. Crown Heritage Spiral Stairs provide an easier installation and a more appealing look than typical kit stairs. Choose from 20 models. See all models and options at www.crownheritage.com.



Model D100



Model D105



Model D154

WOOD COLLECTIONS

Nothing compares to the natural beauty and timeless appeal of a wood balustrade. From traditional turned newel designs to handcrafted box newels, Crown Heritage offers what you need for your beautiful stair.



*Pictured here with 9015 baluster,
4102 newel and 6002 handrail*

STAIN GRADE BOX NEWELS



4074 - 3-1/4"

PRIMED BOX NEWELS

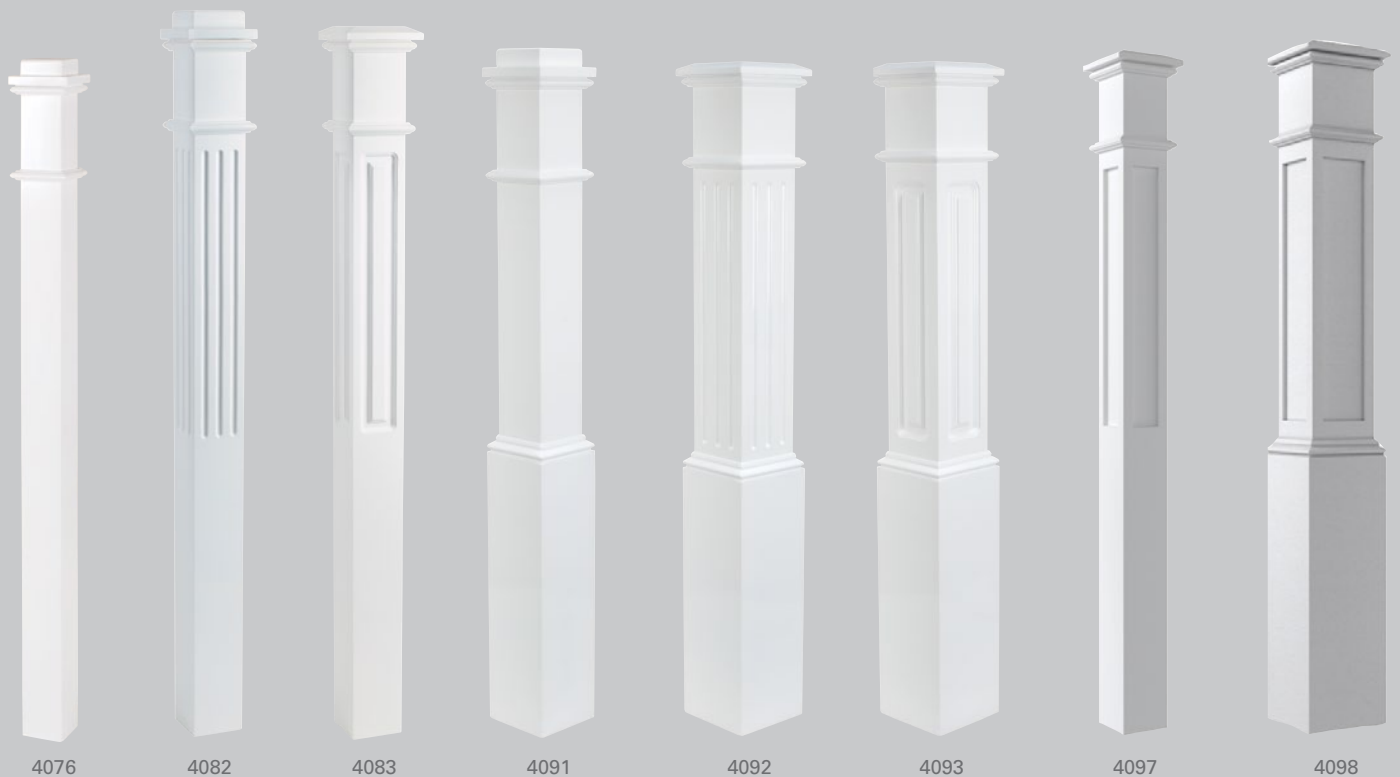



INTERCHANGEABLE NEWEL CAP SYSTEM

Most box newels come with two interchangeable caps.



Bevel Cap



Square Cap

Box Newel Details

Hollow Bottom Newels	Installation Blocks	Sleeve	Two caps
Product #			
4082	Included	Order Separate	Included
4083	Included	Order Separate	Included
4091	Included	Included	Included
4092	Included	Included	Included
4093	Included	Included	Included
4097	Included	Order Separate	Included
4098	Included	Included	Included
4191	Included	Included	Included

4083 newel with 1061 and 1062 balusters



PRIMED BOX NEWELS

4" PRIMED BOX NEWELS

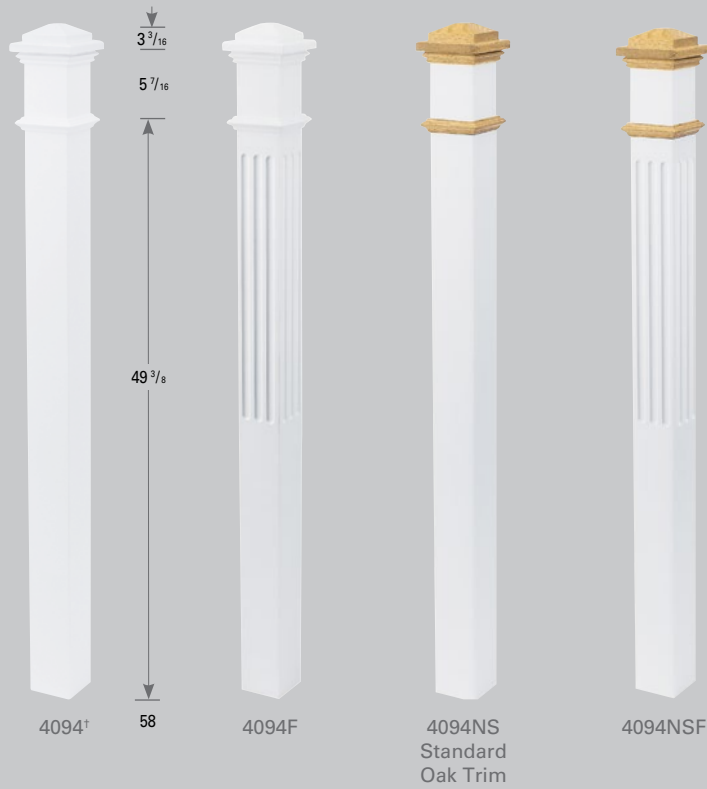

ALL 4094 / 4095 NEWELS HAVE SOLID BOTTOMS

5" PRIMED BOX NEWELS

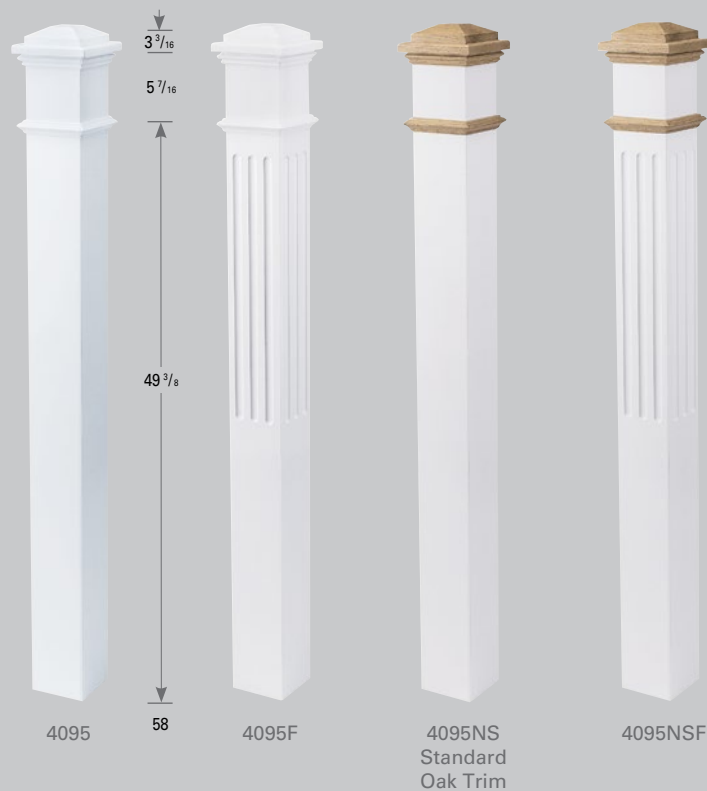



*Pictured with 5360 balusters
and 6310 handrail.*

design your own
NEWEL POSTS 

NCT (NO CAP OR TRIM) BOX NEWELS

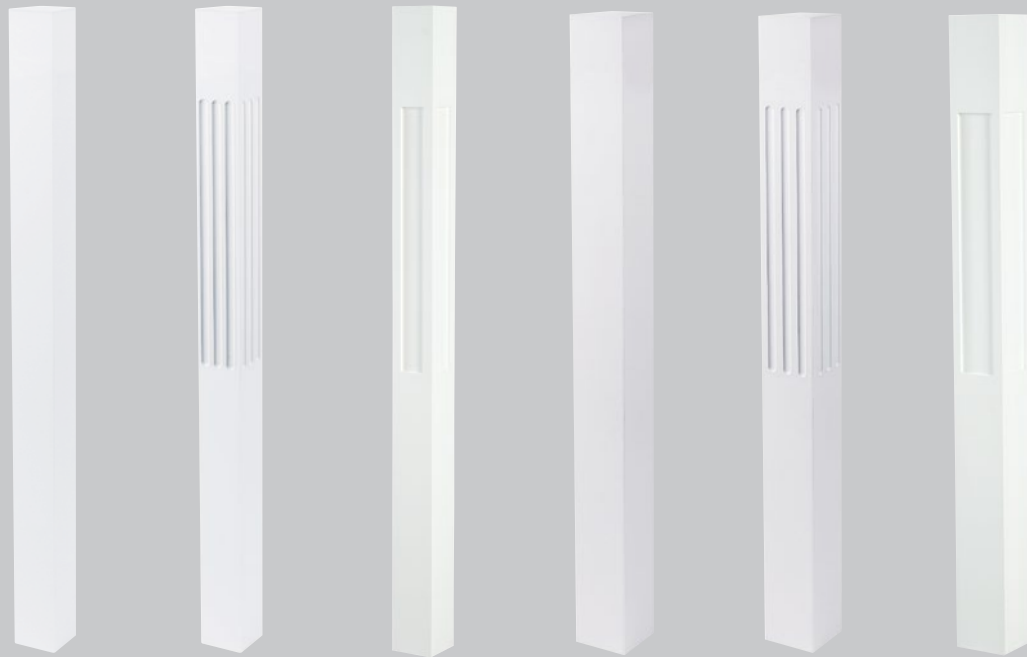

4094NCT
 (4" Post)
 ALSO AVAILABLE IN
 RED OAK AND
 WHITE OAK

4094FNCT
 (4" Post)

4094CNCT
 (4" Post)

4095NCT
 (5" Post)
 ALSO AVAILABLE IN
 RED OAK AND
 WHITE OAK

4095FNCT
 (5" Post)

4095CNCT
 (5" Post)

STAIN GRADE CAP AND TRIM OPTIONS

4094 / 4095 trim kit species options to be used with NCT newels available in plain, fluted or craftsman.



4094CCT (4" Post)
 or 4095CCT (5" Post)
 Craftsman Cap and Trim
 Available in Red Oak,
 White Oak
 or Poplar



4094CT (4" Post)
 or 4095CT (5" Post)
 Peaked Cap and Trim
 Available in Red Oak,
 White Oak, Beech
 or Maple



4094RCT (4" Post)
 or 4095RCT (5" Post)
 Raised Cap and Trim
 Available in Red Oak,
 White Oak
 or Poplar



*Pictured here with 5360 balusters
and 4094CNCT newel post
with 4094CCT cap and trim.*

**Crown[®]
Heritage**

design your own
NEWEL POSTS



BOX NEWEL ACCESSORIES

STAIN GRADE BASE SLEEVES

PRIMED BASE SLEEVES

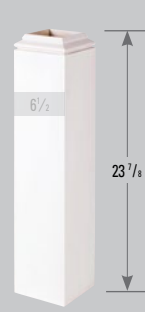
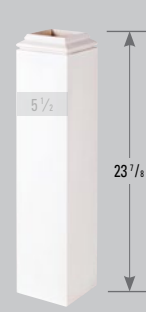
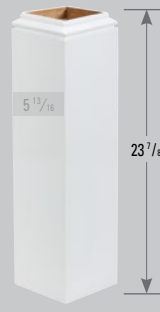
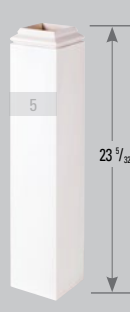
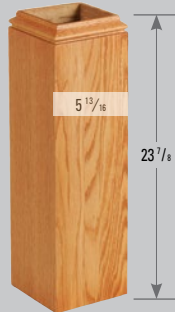

HARDWARE

7-1/4" LANDING TREAD

3094 Starting Newel Attachment Kit

3074 12" Lag Screw



3094 assembly is required when a floor is hollow and no joist is available.

3074 is required for joist installations. This 12" lag screw ensures a stronger bond with the joist.

Warning: Standard 10" lag screws are not long enough to provide as secure a bond with the floor joist.

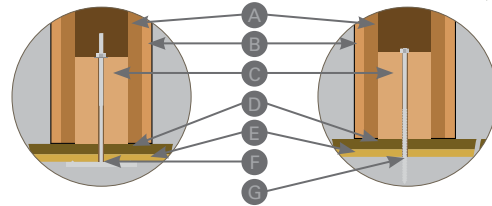

BOX NEWEL FITTINGS*



* FITS WITH 6210 HANDRAIL AND 4091 BOX NEWELS



*Pictured with 4091 newel,
5370 balusters, 6210 handrail
and box newel fittings.*

WOOD SIERRA COLLECTION

CROWN SYSTEM

3 LENGTH SYSTEM

HANDRAILS-NOT PLOWED

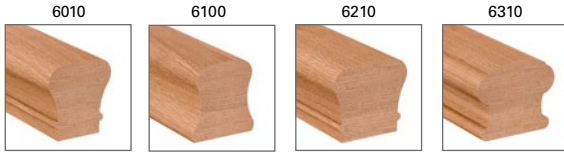

This collection is most commonly paired with these not-plowed and plowed handrail profile options.

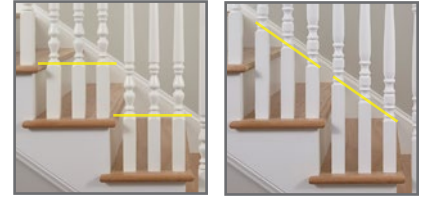

PIN TOP BALUSTERS

2011 3-length System 1 1/4"

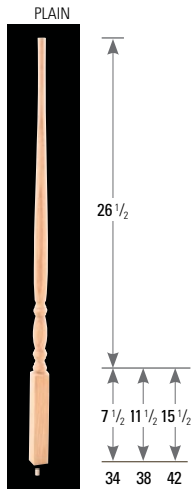

2013 Crown System* 1 1/4"

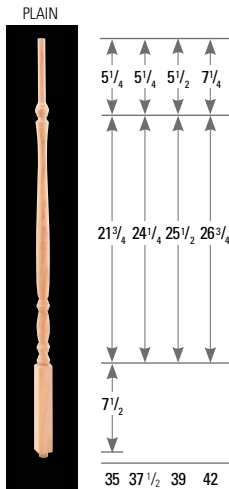

2111 3-length System 1 3/4"

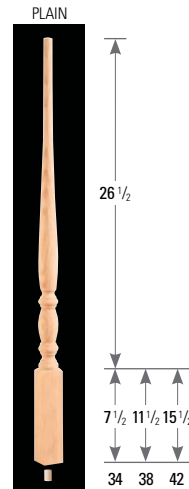

2115 Crown System 1 3/4"

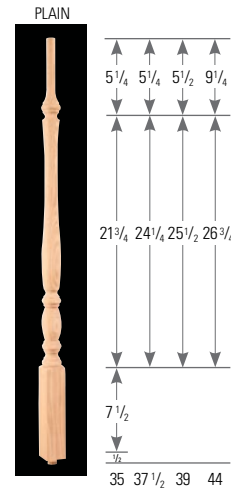

HANDRAILS-PLOWED



SQUARE TOP BALUSTERS

2025 Crown System 1 1/4"

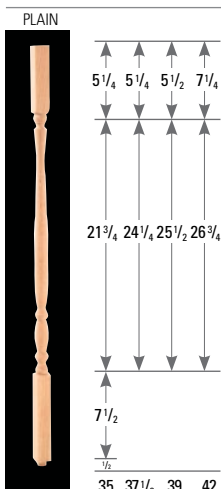

2105 Crown System 1 3/4"

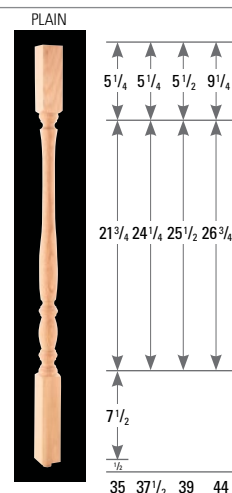

Pictured with 2013 balusters and 3242 newel.

OVER-THE-POST NEWELS - WITH PIN TOP

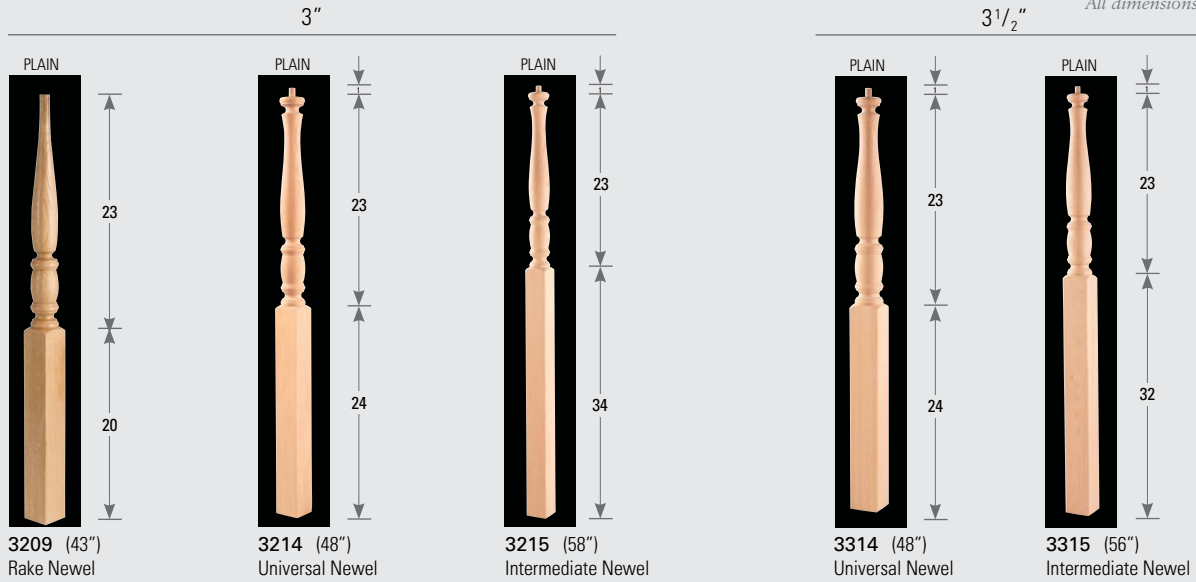

POST-TO-POST NEWELS - WITH BALL TOP

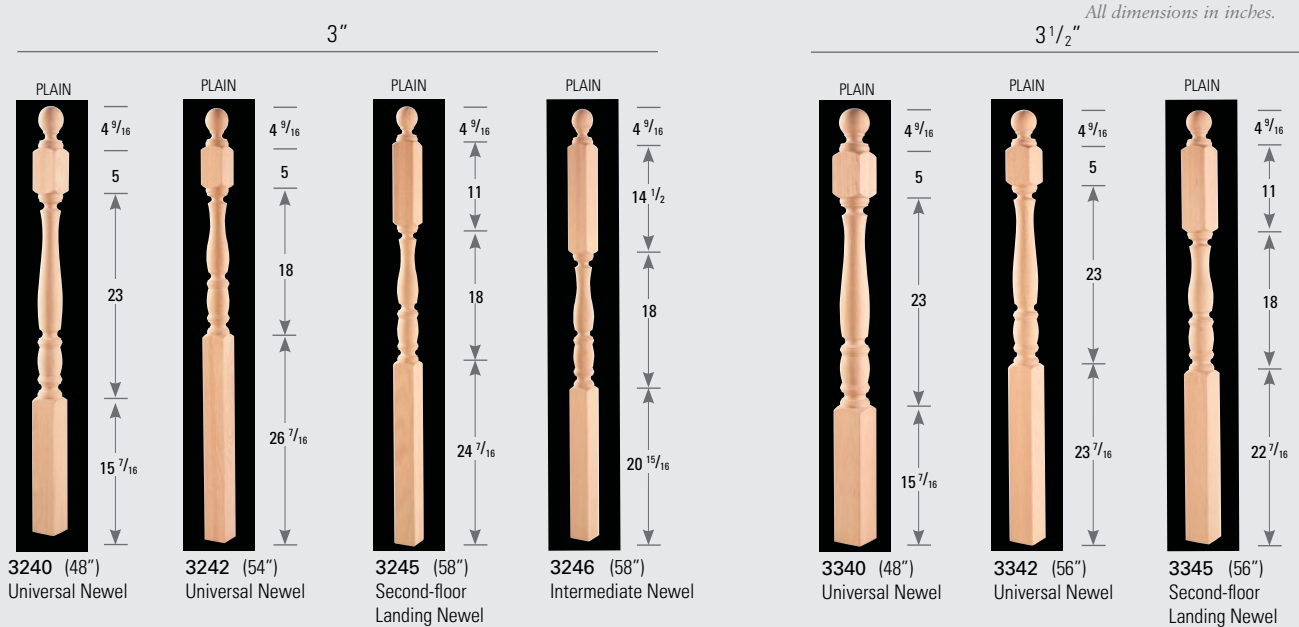

JEFFERSON COLLECTION

HANDRAILS - NOT PLOWED

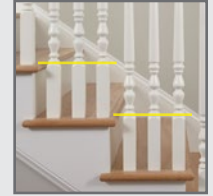

PIN TOP BALUSTERS - 1 3/4"

OVER-THE-POST NEWELS - WITH PIN TOP

8515 Crown System*

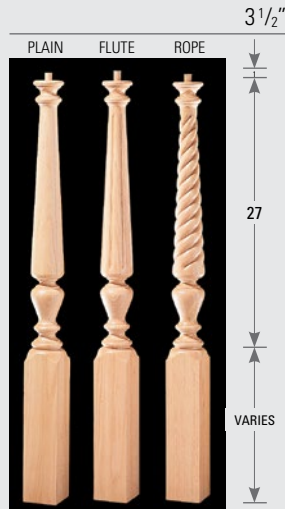
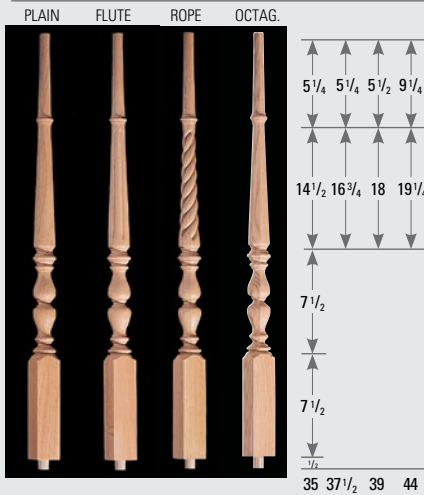

8510 (43") Universal Newel
 8514 (48") Universal Newel
 8525 (56") Intermediate Newel

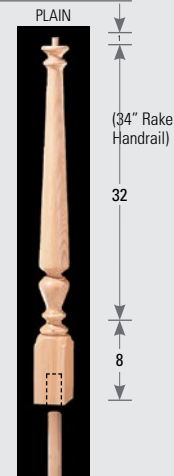

8513 (41") Volute Newel
Dowel is removable.

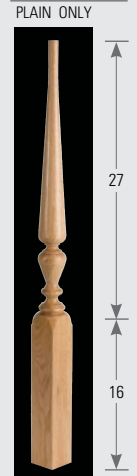

8512 (43") Rake Newel

POST-TO-POST NEWELS - 3 1/2" WITH SPADE TOP

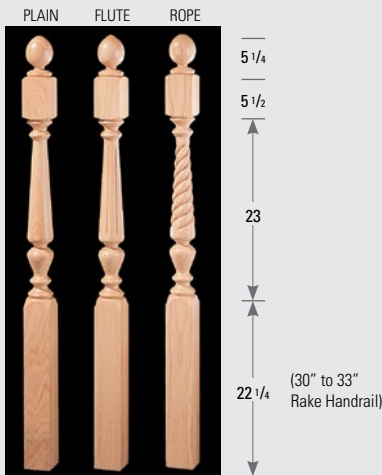

8542 (56") Universal Newel



8545 (56") Second-floor Landing Newel

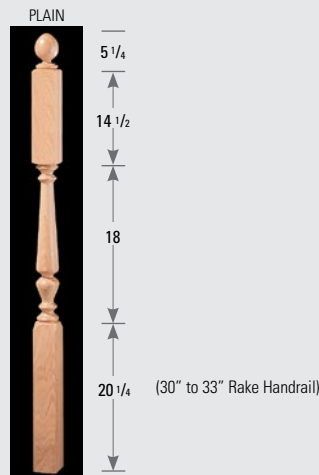

8547 (58") Intermediate Newel



8515 Balusters & 8542 Newel

Jefferson Post-to-Post

1800s COLLECTION

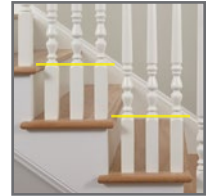

HANDRAILS-NOT PLOWED



This collection is most commonly paired with these not-plowed and plowed handrail profile options.

PIN TOP BALUSTERS

1815 Crown System* 1 3/4"

1825 Crown System 2 1/4"

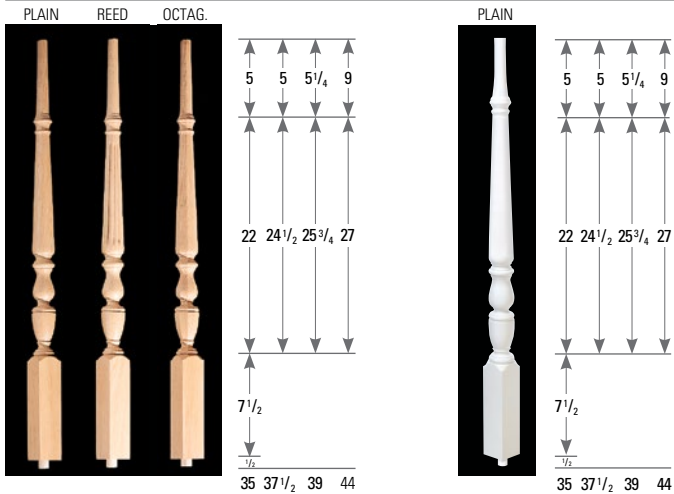

HANDRAILS-PLOWED



SQUARE TOP BALUSTERS - 1 3/4"

1805 Crown System

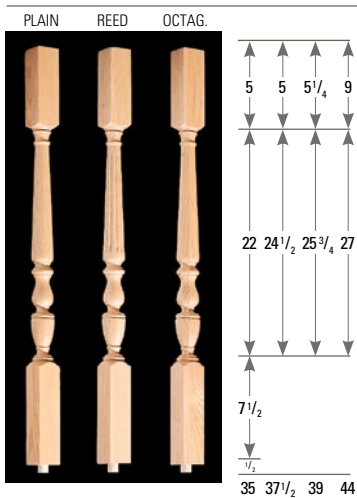

Pictured with 1815 Balusters

OVER-THE-POST NEWELS - WITH PIN TOP

All dimensions in inches.

3 1/2"

27

15" - 4810
20" - 4814
28" - 4825

VARIES

4810 (43") Universal Newel
4814 (48") Universal Newel
4825 (56") Intermediate Newel

33 (34" Rake Handrail)

6 1/2

4813 (40 1/2") Volute Newel
Dowel is removable.

3"

27

16

4812 (43") Rake Newel

POST-TO-POST NEWELS - 3 1/2" WITH URN TOP

All dimensions in inches.

5

5

23

23 (30" to 36" Rake Handrail)

4842 (56") Universal Newel

PLAIN

5

11

18

22

4845 (56") Second-floor Landing Newel

PLAIN

5

14 1/2

18

20 1/2

4866 (58") Intermediate Newel



CAROLINA COLLECTION



3 LENGTH SYSTEM

HANDRAILS-NOT PLOWED

6310

6519

6210



This collection is most commonly paired with these not-plowed and plowed handrail profile options.

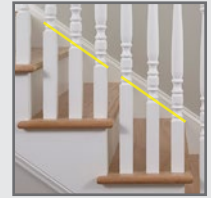
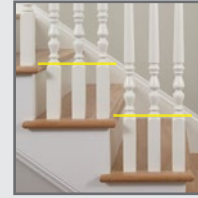

PIN TOP BALUSTERS - 1 3/4"

2015 3-length System

PLAIN FLUTE TWIST OCTAG.



2016 Crown System*

PLAIN FLUTE TWIST



HANDRAILS-PLOWED

6310P

6519P

6210P



SQUARE TOP BALUSTERS - 1 3/4"

2005 3-length System

PLAIN FLUTE TWIST OCTAG.



2006 Crown System

PLAIN FLUTE TWIST

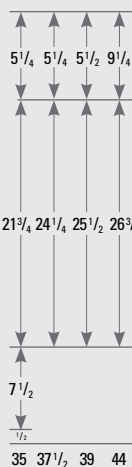

Pictured with 2016 fluted balusters and 4091 newel.

OVER-THE-POST NEWELS - WITH PIN TOP

All dimensions in inches.

$3\frac{1}{2}''$

PLAIN FLUTE TWIST OCTAG.

27

VARIES 15" - 3010
20" - 3014
28" - 3015
44" - 3018

3010 (43") Universal Newel
3014 (48") Universal Newel
3015 (56") Intermediate Newel
3018 (72") Winder Newel

PLAIN

32 (34" Rake Handrail)

8

3013 (41") Volute Newel
Dowel is removable.

PLAIN ONLY

27

16

3012 (43") Rake Newel

POST-TO-POST NEWELS - $3\frac{1}{2}''$ WITH ACORN TOP

All dimensions in inches.

PLAIN FLUTE TWIST OCTAG.

5

5

23

VARIES 15" - 3040 (30" to 33" Rake Handrail)
23" - 3042 (34" to 38" Rake Handrail)
39" - 3055 (Either 30" or 34" Rake Handrail)

3040 (48") Universal Newel
3042 (56") Universal Newel
3055 (72") Winder Newel

PLAIN

5

11

18

24

3045 (58")
Second-floor
Landing Newel

PLAIN

5

14 1/2

18

VARIES 34 1/2" - 3046
20 1/2" - 3047

3046 (72") Winder Newel
3047 (58") Intermediate Newel

HAMPTON COLLECTION



3 LENGTH SYSTEM

HANDRAILS - NOT PLOWED



This collection is most commonly paired with these not-plowed and plowed handrail profile options.

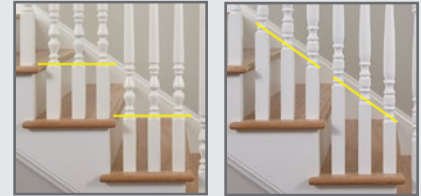

PIN TOP BALUSTERS

5200 3-length System 1 1/4" 5300 3-length System 1 3/4" 5301 Crown System* 1 3/4"

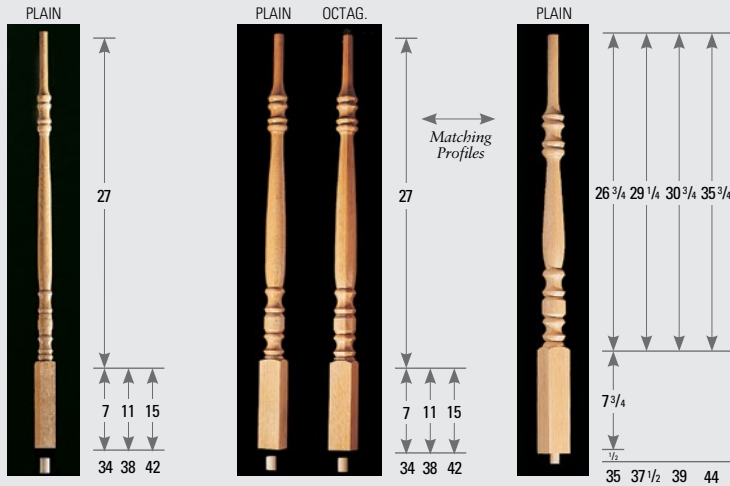

5200 Balusters & 4270 Newel

Hampton Over-the-Post

HANDRAILS - PLOWED

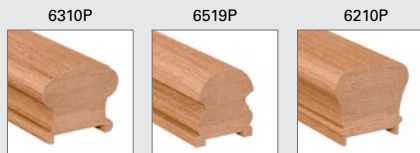

SQUARE TOP BALUSTERS

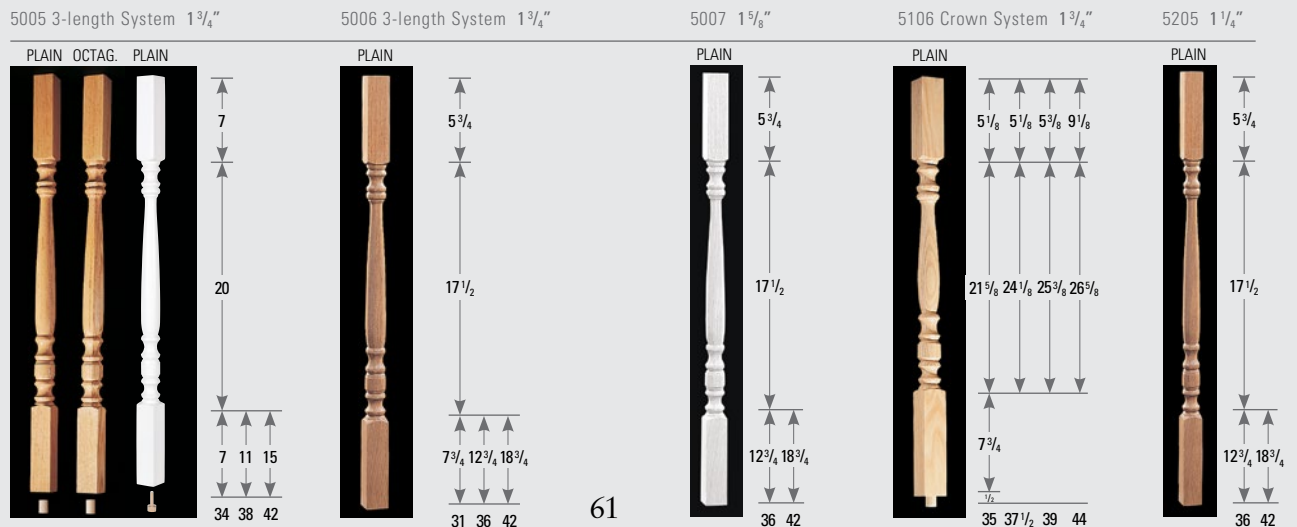

OVER-THE-POST NEWELS - WITH PIN TOP

All dimensions in inches.

3 1/2"

PLAIN OCTAG.

27

VARIES

15" - 4270
20" - 4274
28" - 4275
44" - 4278

PLAIN

32 (34" Rake Handrail)

8

4270 (43") Universal Newel
4274 (48") Universal Newel
4275 (56") Intermediate Newel
4278 (72") Winder Newel

3"

PLAIN ONLY

27

16

4212 (43") Rake Newel

4270 (43") Universal Newel
4274 (48") Universal Newel
4275 (56") Intermediate Newel
4278 (72") Winder Newel

4272 (41") Volute Newel
Dowel is removable.

POST-TO-POST NEWELS - WITH BALL TOP

All dimensions in inches.

3 1/2"

PLAIN OCTAG.

VARIES

3 1/2" - 4500, 4502
5 1/2" - 4664, 4665

5" - 4500, 4664, 4665
6 1/2" - 4502

VARIES

23" - 4500
17 1/2" - 4502, 4664, 4665

VARIES

16 1/2" - 4500 (30" to 33" Rake Handrail)
28 1/2" - 4502 (34" to 38" Rake Handrail)
20" - 4664 (30" to 38" Rake Handrail)
28" - 4665 (30" to 38" Rake Handrail)

PLAIN

3 1/2

VARIES

11" - 4503, 4507
14 1/2" - 4505, 4508

17 1/2

VARIES

24" - 4503 (30" to 38" Rake Handrail)
36 1/2" - 4505 (30" to 38" Rake Handrail)
16" - 4507 (30" to 38" Rake Handrail)
22 1/2" - 4508 (30" to 38" Rake Handrail)

4500 (48") Universal Newel
4502 (56") Universal Newel
4664 (48") Universal Newel (4 1/2" square)
4665 (56") Universal Newel (4 1/2" square)

2 1/2"

PLAIN

VARIES

45 1/2" - 4004 (30" to 33" Rake Handrail)
53 1/2" - 4005 (30" to 38" Rake Handrail)
69 1/2" - 4006 (30" to 38" Rake Handrail)

Ball Top Spade Top

4004 (48") Universal Newel
4005 (56") Intermediate Newel
4006 (72") Winder Newel

4500 (48") Universal Newel
4502 (56") Universal Newel
4664 (48") Universal Newel (4 1/2" square)
4665 (56") Universal Newel (4 1/2" square)

4503 (56") Second-floor Landing Newel
4505 (72") Intermediate Newel
4507 (48") Second-floor Landing Newel
4508 (58") Intermediate Newel

4004 (48") Universal Newel
4005 (56") Intermediate Newel
4006 (72") Winder Newel

4004, 4005 and 4006 are available in Mushroom, Ball and Spade Top.

4664 and 4665 are available in PLAIN only.

COLONIAL COLLECTION



3 LENGTH SYSTEM

HANDRAILS-NOT PLOWED

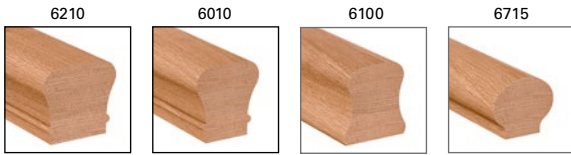

This collection is most commonly paired with these not-plowed and plowed handrail profile options.

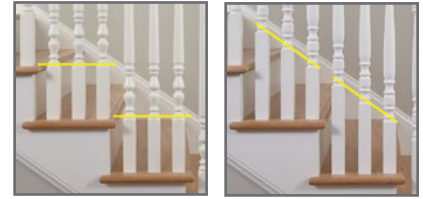

PIN TOP BALUSTERS - 1 1/4"

5090 1" Baluster	5015 ⁴ 3-length System	5010 1 1/2" Baluster	5016 ⁴ 1 1/4" Baluster	5891 1 1/4" Baluster	5892 1 1/4" Baluster	5894 1 1/4" Baluster
PLAIN (ROUND)	PLAIN	PLAIN	PLAIN	PLAIN	PLAIN	PLAIN

HANDRAILS-PLOWED



SQUARE TOP BALUSTERS - 1 1/4"

5067 ⁵ 3-length System	5068 ⁵ Crown System*	5141 ⁶ 3-length System	5142 ⁶ Crown System
PLAIN	PLAIN	PLAIN	PLAIN



5142 Balusters & 4040 Newel

Colonial Post-to-Post

⁴5015 and 5016 have matching profiles.
⁵5067 and 5068 have matching profiles.
⁶5141 and 5142 have matching profiles.

CRAFTSMAN COLLECTION

HANDRAILS—NOT PLOWED



6002

6602

6840

HANDRAILS—PLOWED



6000P
1 1/4"

6001P
1 3/4"

This collection is most commonly paired with these not-plowed and plowed handrail profile options.

BALUSTERS

5060
1 1/4" Baluster

5360
1 3/4" Baluster

5061—Eased Edge
1 1/4" Baluster

5361—Eased Edge
1 3/4" Baluster

5070
1 1/4" Baluster

5370
1 3/4" Baluster

5380
1 3/4" Baluster

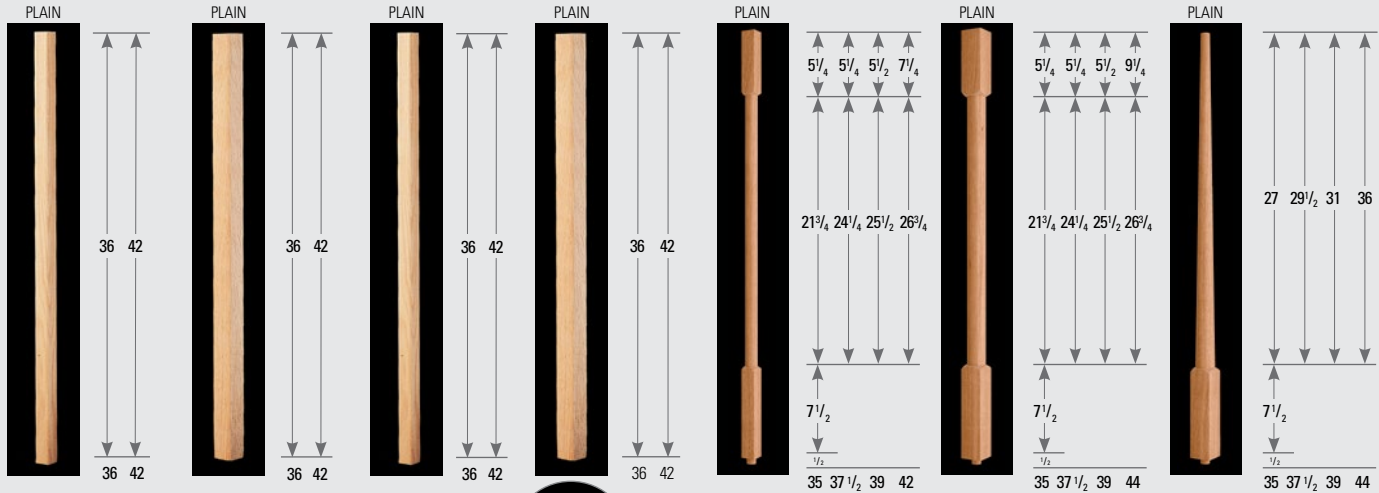

Detail of eased edge
baluster bottom



PROFILED NEWELS

3" Newels

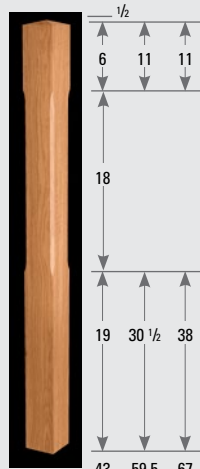

4086 (43")
4087 (59.5")
4088 (67")

3 1/4" Newels

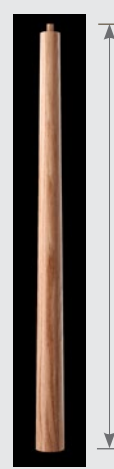

4118 * (48") Universal
4119 * (56") Intermediate

3 1/2" Newels

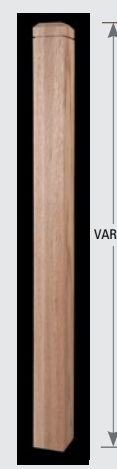

4100 (48") Universal
4101 (56") Intermediate

* Both the 4118
and 4119 are
round newels.

4086 Newel

PLAIN NEWELS PINTOP NEWELS

3" Newels

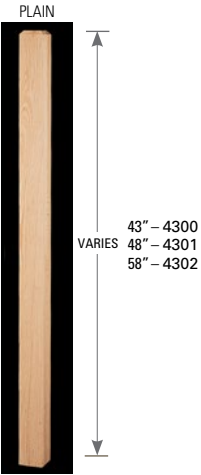

43" - 4300
48" - 4301
58" - 4302

4300 (43") Universal
4301 (48") Intermediate
4302 (58") Intermediate

3 1/2" Newels

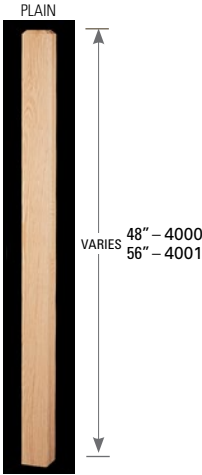

48" - 4000
56" - 4001

4000 (48") Universal
4001 (56") Intermediate

4" Newels

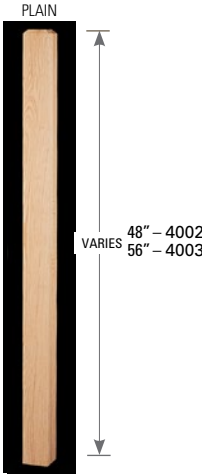

48" - 4002
56" - 4003

4002 (48") Universal
4003 (56") Intermediate

3 1/2" Newels

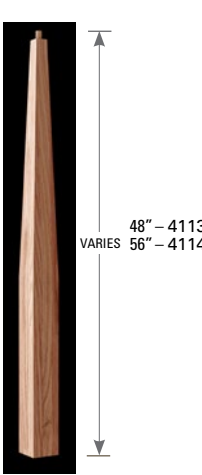

48" - 4113
56" - 4114

4113 (48") Universal
4114 (56") Intermediate
(Both newels are square tapered)

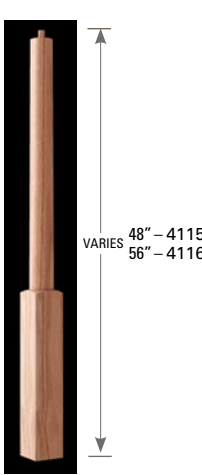

48" - 4115
56" - 4116

4115 (48") Universal
4116 (56") Intermediate

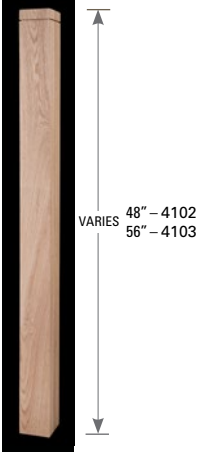

48" - 4102
56" - 4103

4102 (48") Universal
4103 (56") Intermediate

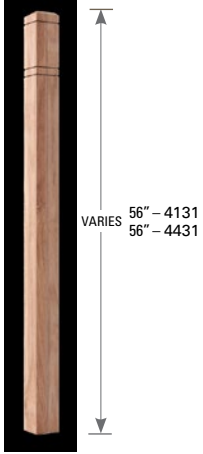

56" - 4131
56" - 4431

4131 (56") Universal
4431 (56") 4 1/2" sq.

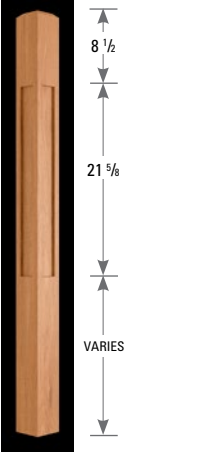

8 1/2
21 5/8
VARIES

4007 (48") Universal
4008 (56") Intermediate

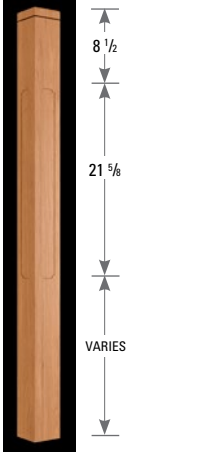

8 1/2
21 5/8
VARIES

4108 (48") Universal
4109 (56") Intermediate



4108 and 4109 Newel Panel

CRAFTSMAN WORKSHOP



CUSTOM STAIRPARTS

Alder



American Cherry

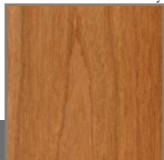

Beech

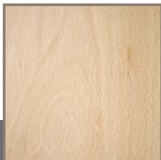

Black Walnut

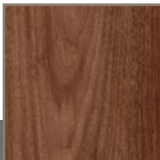

Brazilian Cherry

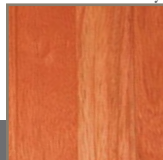

Hemlock

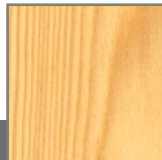

Hickory

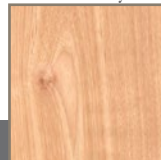

Mahogany





TURNINGS

Whether it is a historical part or your own unique design, Crown Heritage can manufacture newels and balusters to your specifications with our Locatelli Copy Lathe.



BOX NEWELS

Small or large, short or tall - it's your design! Custom caps, panels or flutes.



CURVED BALCONY RAIL AND LANDING TREAD

Provide us a detailed template or drawings showing your desired radius.



FITTINGS

Custom volute or turnout sizes and custom angles on goosenecks or turns.

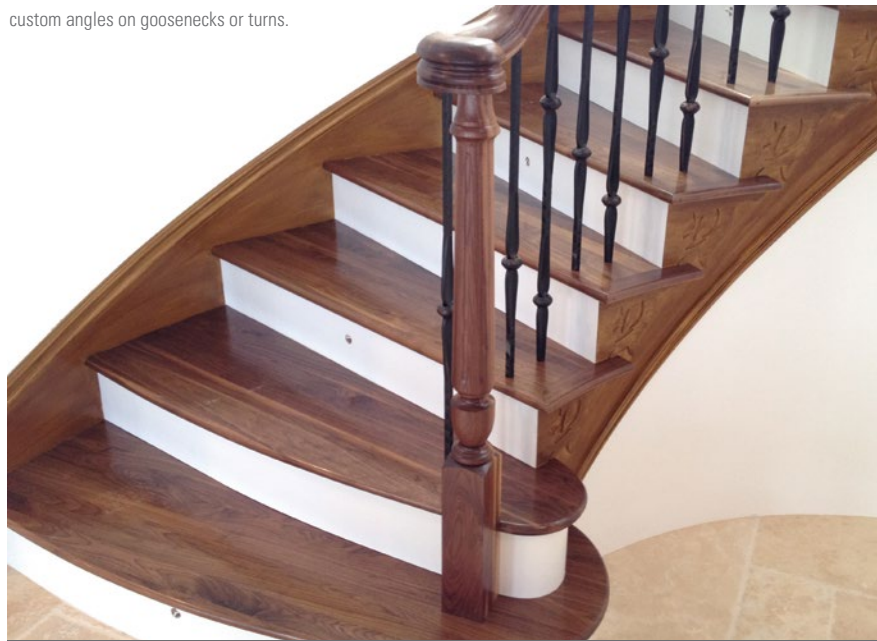

TREADS AND STEPS

Double or single return treads, curved, radius end, and pie treads. Custom double or single end steps, custom radius or stacked steps.

Maple

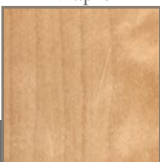

New Heart Pine

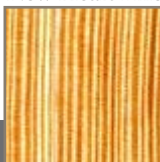

Poplar



Red Oak

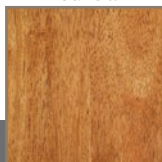

White Oak

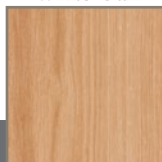

Yellow Birch

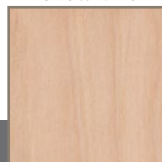

Yellow Pine



CONCEPT GALLERY

Get inspired by one of these unique designs! Choose one of these custom designs or create your own. Custom design may require a short lead time.

CRAFTSMAN STYLE



1



2



3

Item# 4108

NOW STOCKED
3 1/2



4

Item# 4007

NOW STOCKED
3 1/2



5



6

TURNED NEWELS



7



8



11



12

BALUSTERS

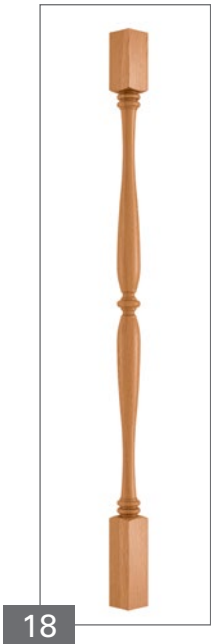
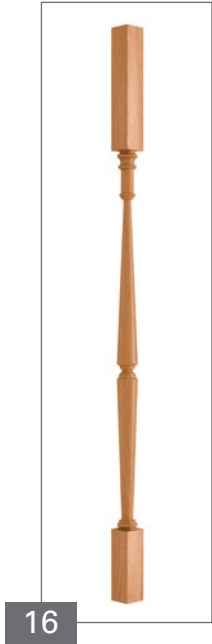
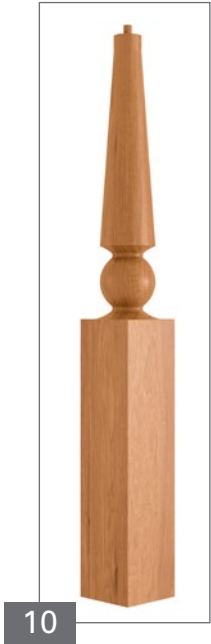

FITTINGS & COMPONENTS

CAPS & EASINGS



7008
7208
4" Coped End

7009/7109
7209/7309
7509
4" Returned End

7010/7110
7210/7310
7510
7710/7810
Starting Easing

7011/7111
7211/7311
7511
7711/7811
90° Level
Quarter Turn

7011S-LH
7111S-LH
7211S-LH
7311S-LH
4 3/4" Offset Rail

7011S-RH
7111S-RH
7211S-RH
7311S-RH
4 3/4" Offset Rail

7012/7112
7212/7312
7512
7712/7812
60° Up Easing

7013/7113
7213/7313
7513
7713/7813
Over Easing



VOLUTES & TURNOUTS



7030/7130
7230/7330
7530
Left-hand Volute

7035/7135
7235/7335
7535
Right-hand Volute

703090
723090
733090
90° Left-hand
Volute

703590
723590
733590
90° Right-hand
Volute

7031/7231
Left-hand
Rising Volute

7036/7236
Right-hand
Rising Volute

7040/7140
7240/7340
7540
Left-hand Turnout



GOOSENECKS

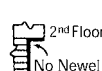

7050
7250
7550
Left-hand
2 pc. Riser
No Cap

7055
7255
7555
Right-hand
2 pc. Riser
No Cap

7060
7260
7160
7360
7560
Left-hand
2 pc. Riser
With Cap

7065
7265
7165
7365
7565
Right-hand
2 pc. Riser
With Cap

7071
7171
7271
7371
7571
Left-hand
2 pc. Riser
No Cap

7076
7176
7276
7376
7576
Right-hand
2 pc. Riser
No Cap

7081
7181
7281
7381
7581
Left-hand
2 pc. Riser
With Cap

7086
7186
7286
7386
7586
Right-hand
2 pc. Riser
With Cap



FITTINGS

All dimensions in inches.

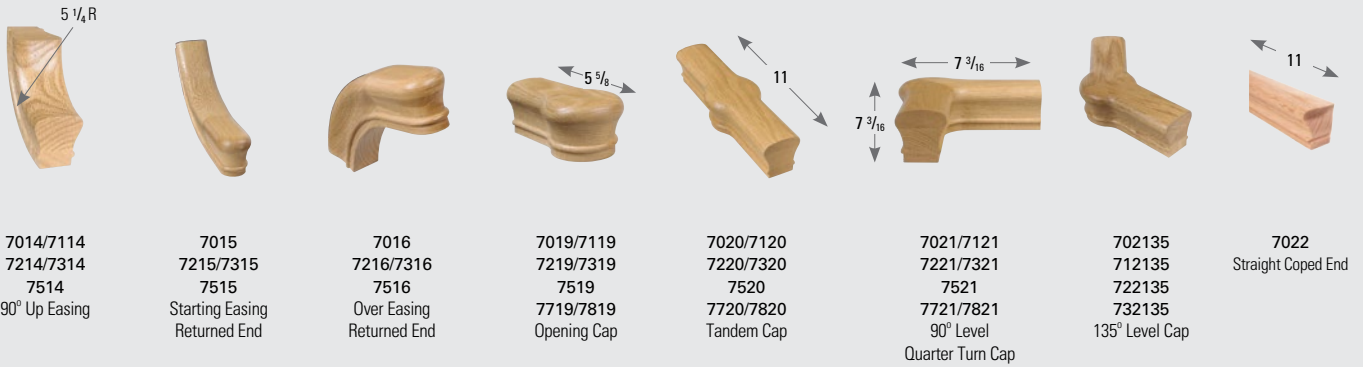

7014/7114
7214/7314
7514
90° Up Easing

7015
7215/7315
7515
Starting Easing
Returned End

7016
7216/7316
7516
Over Easing
Returned End

7019/7119
7219/7319
7519
7719/7819
Opening Cap

7020/7120
7220/7320
7520
7720/7820
Tandem Cap

7021/7121
7221/7321
7521
7721/7821
90° Level
Quarter Turn Cap

702135
712135
722135
732135
135° Level Cap

7022
Straight Coped End

HOW TO MATCH FITTINGS AND RAIL STYLES

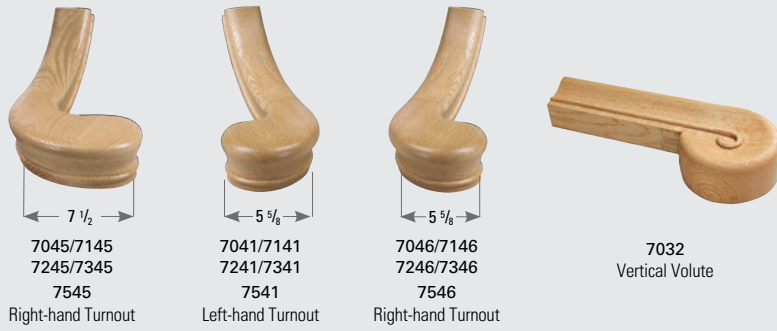

7045/7145
7245/7345
7545
Right-hand Turnout

7041/7141
7241/7341
7541
Left-hand Turnout

7046/7146
7246/7346
7546
Right-hand Turnout

7032
Vertical Volute



7000 Series
Fittings match
6010
Rail Profile



7100 Series
Fittings match
6100
Rail Profile



7200 Series
Fittings match
6210
Rail Profile



7300 Series
Fittings match
6310
Rail Profile



7500 Series
Fittings match
6519
Rail Profile



7700 Series
Fittings match
6715
Rail Profile



7800 Series
Fittings match
6840
Rail Profile



7089
7189
7289
7389
7589
2 pc. Riser
With Cap

70902
71902
72902
73902
75902
Left-hand
2 pc. Riser
5 1/2" Offset
To Center of Rail

70952
71952
72952
73952
75952
Right-hand
2 pc. Riser
5 1/2" Offset
To Center of Rail

70912
72912
73912
75912
Left-hand
2 pc. Riser
With Cap
5 1/2" Offset
To Center of Rail

70922
72922
73922
75922
Right-hand
2 pc. Riser
With Cap
5 1/2" Offset
To Center of Rail

7097
7197
7297
7397
7597
2 pc. Riser
With Cap

7099
7199
7299
7399
7599
7799
7899
2 pc. Riser
No Cap

HANDRAILS

All dimensions in inches.

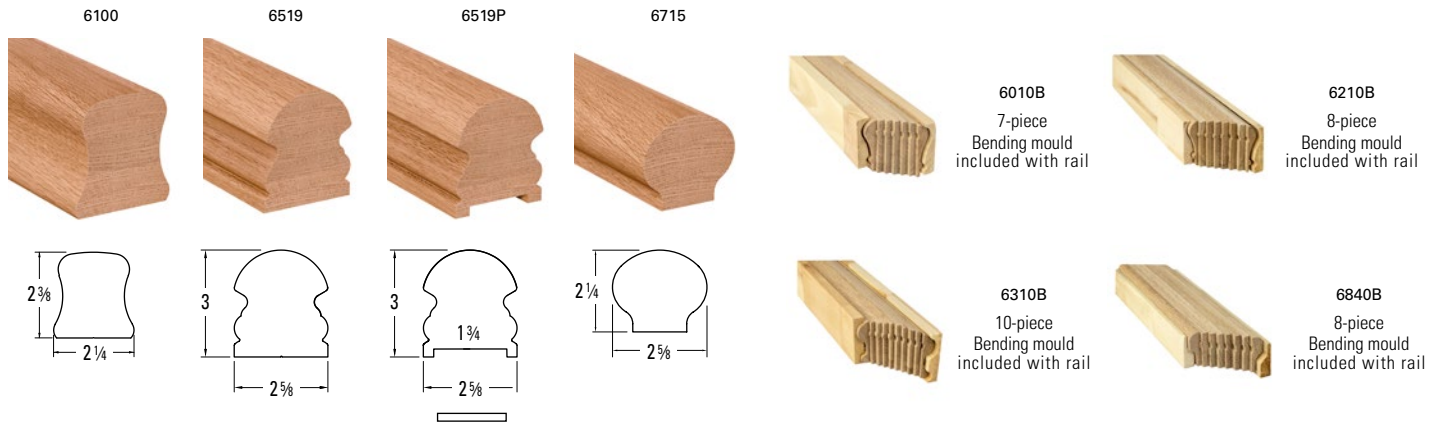
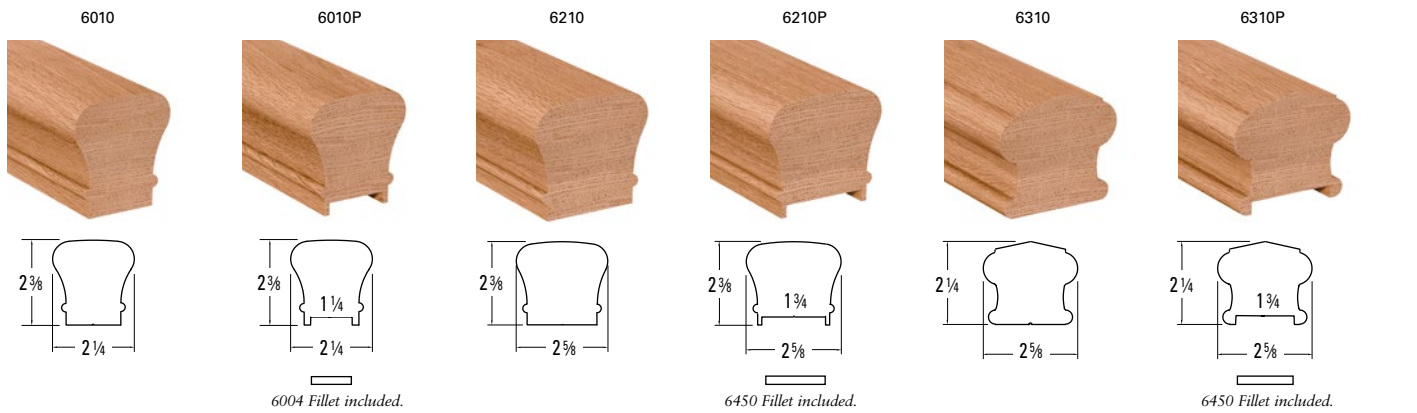
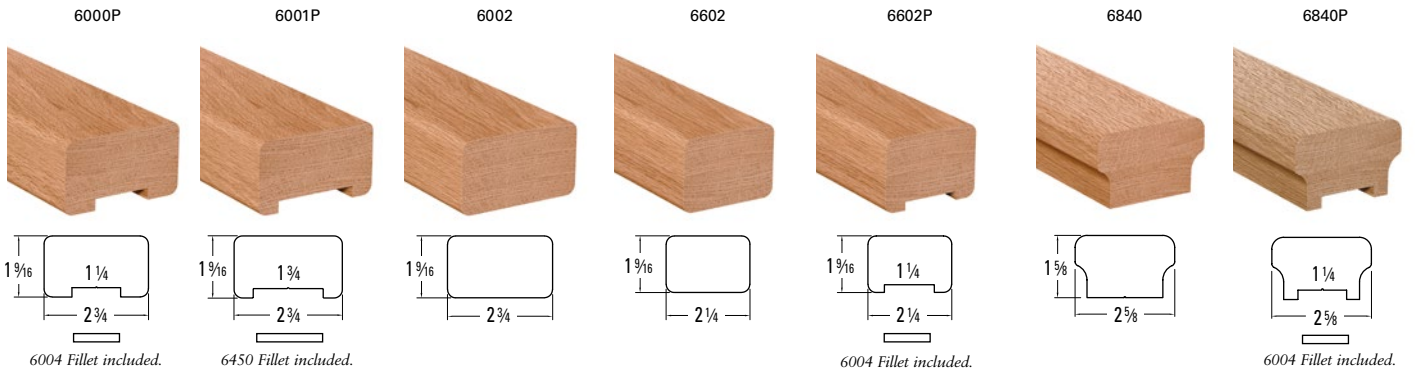

SHOERAILS & FILLETS

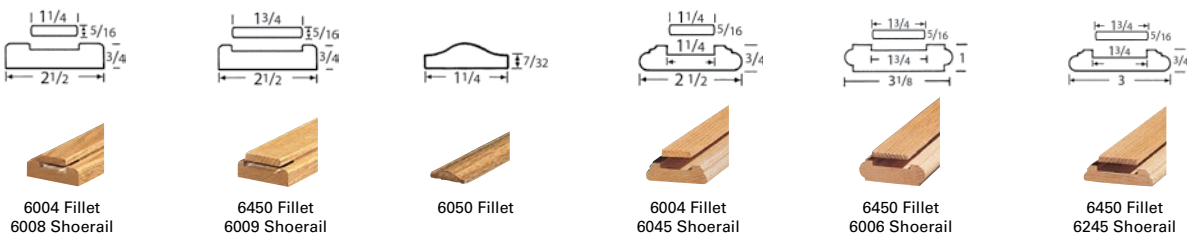

WALL RAIL & FITTINGS

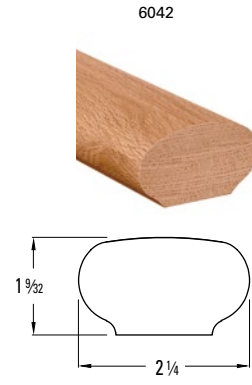
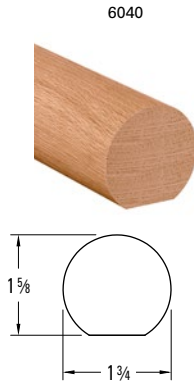
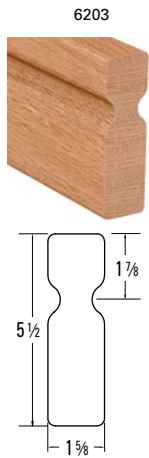

WALL RAIL BRACKETS



3028
Satin Black



3028
Rubbed Copper



3028
Satin Nickel



3028
Oil Rubbed
Bronze



3128
Satin Black



3002
Wall Rail Bracket
Available in Brass, Black,
Nickel, and Bronze



3027
Brass



3027
Bronze



3027
Black



3027
Nickel



3027
Dull Chrome



3027
Bright Chrome

ROSETTES



7026
Round Rosette
4 3/4" Diameter



7027
Oval Rosette
4 7/16" x 6 1/2"



7027SQ
Square Corner Rosette
4 7/16" x 6 1/2"



7037
Oval Rosette
4" x 5 1/2"



TREADS



8070
Plain Tread
1 1/32" x 11 1/2"

8170
Plain Tread
1 1/32" x 10 1/2"

MDF
1 1/8" x 11 1/4"



Mitered Return
Tread Reversible

8070MR
Plain Tread
1 1/32" x 11 1/2"

8170MR
Plain Tread
1 1/32" x 10 1/2"

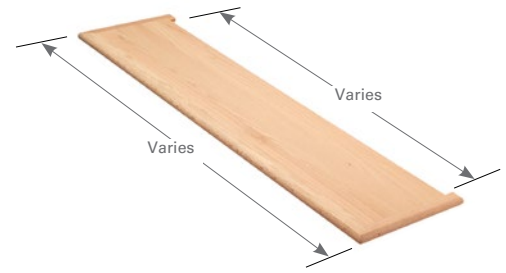

Varies

Varies

8070DMR
Double Mitered Returned Treads:
Overall width of tread does not include
mitered returns.

SQUARE EASED EDGE TREADS



8070SQ
Plain Tread
1 1/32" x 11 1/2"



8070SQMR
Mitered Return
Tread Reversible
1 1/32" x 11 1/2"

SPECIALTY TREADS



8070RTD
Retro Tread

8080RTD15
Return Nosing
(Sold Separately)



8080SQRTD15
Return Nosing
(Sold Separately)

8070SQRTD
RetroCraft Tread



8370
Thick Tread
3" x 11 1/2"

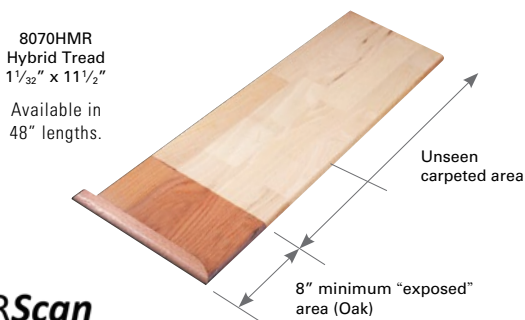

8070HMR
Hybrid Tread
1 1/32" x 11 1/2"

Available in
48" lengths.

Unseen
carpeted area

8" minimum "exposed"
area (Oak)



*Pictured:
RetroCraft Tread*



400082

TREAD BLANKS



Nosed One Edge
8070-20
1 1/32" x 20" Deep
48" and 60" Widths

Nosed Two Edge
8070W34
1 1/32" x 34" Deep
48", 54" and 60" Widths

8070W24
1 1/32" x 24" Deep
60" and 72" Widths

8070W20
1 1/32" x 20" Deep
84" Width



Square Edge
8070W26
1 1/32" x 26"
48", 60" and 84" Widths

8070-48
1 1/32" x 48" x 48"

RISERS



8075
Riser
3/4" x 7 1/2"

8078
Riser
3/4" x 8"



8075 MDF
Riser
3/4" x 8"

Oak Lineal Riser—Solid Oak edge-glued, fingerjointed panel

LANDING TREAD



Landing Tread
8090
3/4" x 3 1/4"
8091
3/4" x 5 1/4"
8097
3/4" x 7 1/4"



8091SQ
Landing Tread
3/4" x 5 1/4"



8091-38
Landing Tread
3/8" x 5 1/4"

8091SQ-38
Landing Tread
3/8" x 5 1/4"



8091B16
Bending Landing Tread
3/4" x 5 1/4" x 16'

Model	Description	Size	Red Oak	Cherry	Hickory	Maple	MDF	Poplar	White Oak	Yellow Pine
8070	Plain	1-1-32" x 11-1/2"								
		36"	X		X					
		42"	X		X	X	X	X	X	
		48"	X	X	X	X	X	X	X	X
		54"	X							X
		60"	X	X	X	X	X	X	X	X
		72"	X		X				X	
		96"	X		X				X	
		144"	X							
		192"	X							
8070DMR	Double Return	1-1-32" x 11-1/2"								
		48"	X							
		54"	X							
8070MR	Single Return	1-1-32" x 11-1/2"								
		42"	X		X	X			X	
		48"	X	X	X	X			X	X
		54"	X						X	
		60"	X	X	X	X			X	X
		72"	X						X	X
8070SQ	Square Edge Tread									
		48"	X						X	
		60"	X						X	
8070SQMR	Sq. Edge Tread Mitered Return									
		48"	X						X	
		60"	X						X	
8075	Riser	3/4" x 7-1/2"								
		36"	X		X					
		42"	X		X	X	X	X	X	
		48"	X	X	X	X	X	X	X	
		54"	X							
		60"	X	X	X	X	X	X	X	
		72"	X							
		96"	X							
		144"	X							
		192"	X							
	Skirtboard									
		12'	X		X				X	X
		16'	X		X				X	X
8070	Solid Pine C & BTR Stepping	1" x 11-1/4"								
		36"								X
		42"								X
		48"								X
		144"								X
		192"								X

Starting steps are shipped with cove and shoe moulding. Single Bullnose Starting Steps are reversible and can be cut for shorter lengths.

Tread Thickness / Riser Codes

80XX = 1-1/32" Stain grade Tread / 7" Stain grade Riser 88XX = 1-1/32" Stain grade Tread / 8" Paint grade Riser 89XX = 13/16" Stain grade Tread / 8" Paint grade Riser

Use With Volute and Turnouts

8210 and 8215 should be used only with an Over-the-Post system. Any volute or turnout may be used.

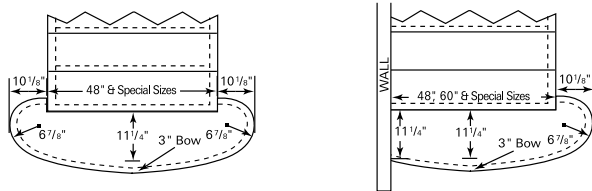

8215

8210

Use 8010 and 8015 with 6010, 6100 and 6210 turnouts or volutes.

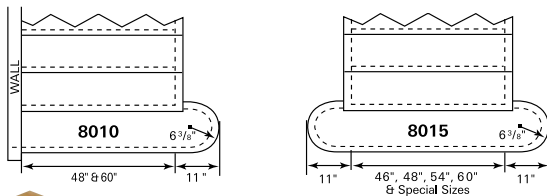

8010 / 8810 / 8910

8015 / 8815 / 8915

Variable Starting Step:
Allows 2 1/2" to be trimmed
off each end to achieve
49" - 54" opening.

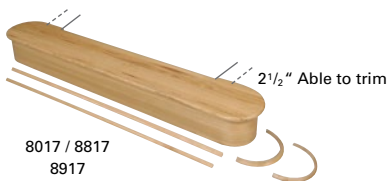

8017 / 8817 / 8917

Use With Box Newels—Use 8030, 8050 and 8030SQ with Box Newels.

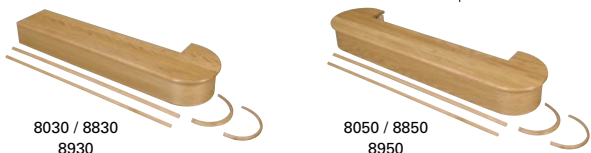
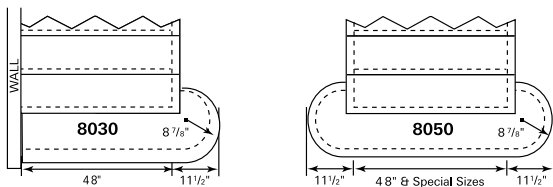

8030 / 8830 / 8930

8050 / 8850 / 8950

Use With Square Top & Box Newels and 90° Starting Fittings

Use 8040 and 8060 when placing any Post-to-Post starting newel at second riser. Use 8440, 8460, 8640 and 8660 when the starting fitting utilizes a 90° up easing. Use 8440 and 8460 with 6010 and 6210 or 6100 volutes. Use 8640 and 8660 with 6210, 6310 and 6519 turnouts or volutes.

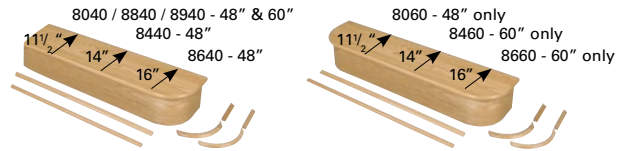
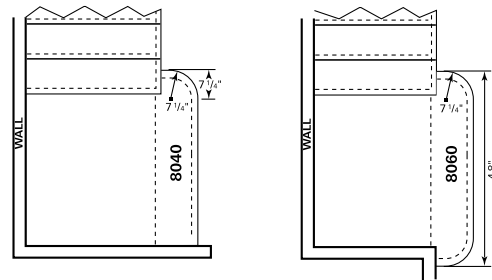

8040 / 8840 / 8940 - 48" & 60"

8440 - 48" 8640 - 48"

8060 - 48" only

8460 - 60" only 8660 - 60" only

Use 8310 and 8315 with 6210, 6310 and 6519 turnouts or standard volutes and all climbing volutes.

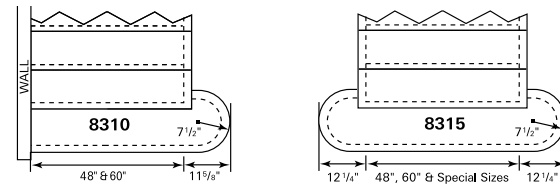

8310

8315

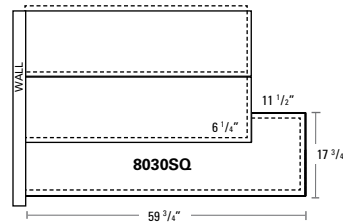

8030SQ

ACCESSORIES

FALSE TREAD KITS

All dimensions in inches.

8079
Open False Tread Kit
 For open tread right-hand or left-hand applications.
 Also can be used in closed tread applications.

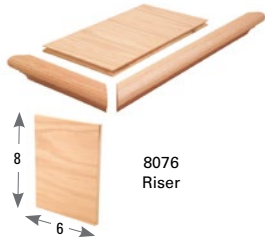

8076
 Riser

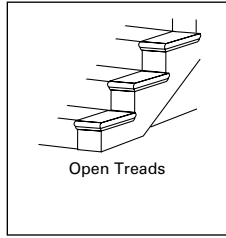

Tread kits include 8076 Risers which also can be purchased separately.



8076
 Riser

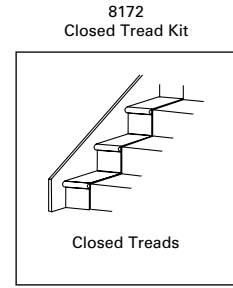

8172
 Closed Tread Kit

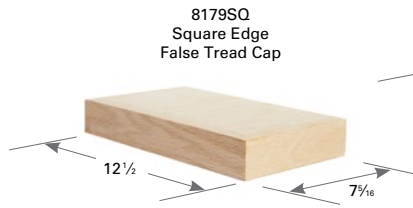

8179SQ
 Square Edge
 False Tread Cap

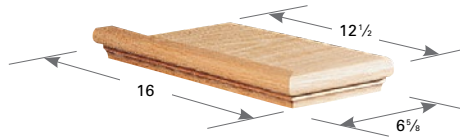

8071
 Right-hand and Left-hand False Tread Cap Only
 Note: Picture shown is a left-hand

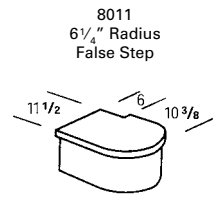

8011
 6 1/4" Radius
 False Step

Note: Product is reversible



8012
 Radius Cove
 and Shoe Set.
 Comes with 8011.

NOSING, MOULDINGS & BRACKETS



8085
 Shoe Moulding
 1/2" x 3/4"



8095
 Cove Moulding
 5/8" x 13/16"



8080
 1 1/16" x 1 1/4"
 Tread Nosing
 13" piece or
 lineal available.



8066
 1 3/4" x 1 1/16"
 Tread Nosing
 with Cove

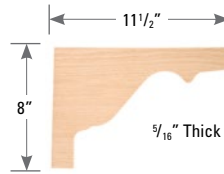

7028
 Plain Bracket

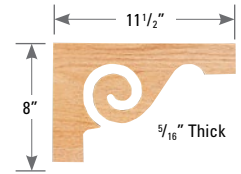

7029
 Scroll Bracket

SKIRTBOARDS



8073
 Primed MDF
 Profiled
 Skirtboard
 3/4" x 11 1/4" x 16'



40012
 Skirtboard
 3/4" x 11 1/4" x 12'

40016
 Skirtboard
 3/4" x 11 1/4" x 16'

Oak Skirtboard—Oak Veneer on one face,
 solid Oak edge-glued, fingerjointed panel substrate
 Maple Skirtboard—Maple Veneer on one face,
 solid Maple edge-glued, fingerjointed panel substrate
 White Oak—Solid White Oak edge-glued, fingerjointed panel

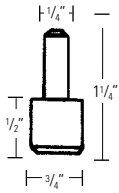

2027
Dowel Pin



3001
Rail Bolt
Oak and Poplar
Plugs Included

3032
Rail Bolt Driver
Drill attachment for driving
rail bolts into newels, fittings,
walls and handrails.

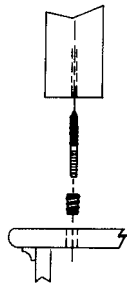

3004
Newel Mounting Kit

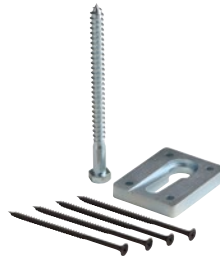

3005
Keylock Fasteners



3087
Mini-lock Fasteners

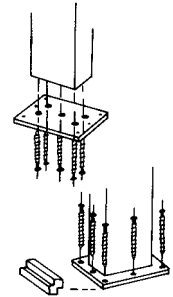

3006
Newel Mounting Plate
(For 3" to 3 1/2" Newels)

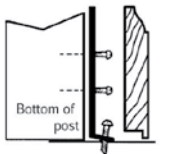

Floor line or flat surface

3009 - 3"
3019 - 3 1/2"
Post Anchor
*Hemlock 3 1/2"



3000-6
1" Wood Plugs
6-Pack

3025
25-Pack



3024
1/2" Tapered Plugs
25pk or 100pk
For Flush Mount
Installations



3026
1/2" Button Plugs
50/Pack



4099
Newel Drop
2 3/4" x 1 3/4"

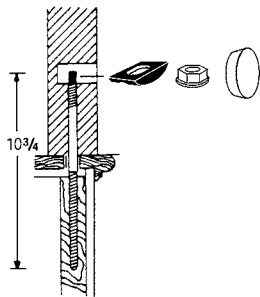

3008
SureTite™
Newel Post Fastener
Red Oak, White Oak and
Maple Plugs Included

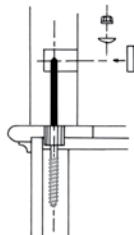

3070
Newel Post
Fastener

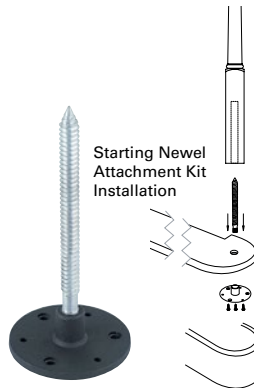

3072
Starting Newel
Attachment Kit*

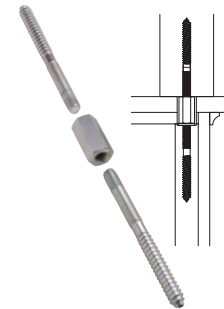

3073
Newel Post
Fastening Kit

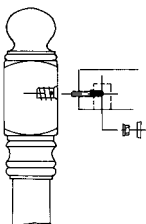

3075
Flush Mount Kit
For flush mounting
handrails to newels.

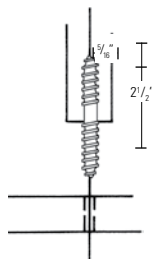

3076-20/ 3076-50
Dowel Screws
Fully-threaded dowel screws for
attaching balusters to treads.
Available in packs of 20 or 50.

3088
Dowel Driver
Drives the 3076 dowel screw.

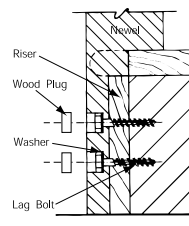

3078
Rail/Post Fastener
Fastens newels to risers
and handrails to newels.
(1 bolt per package)

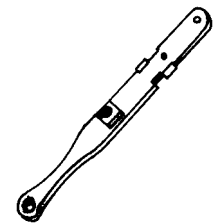

3092
Rail Bolt Wrench
A versatile tool: Locates holes
and pilot holes on handrails
and rail drops, starts and
tightens hex nut on rail bolt,
tightens 1/2" hex nuts, drives
5/16" rail bolts.



*Pictured here with
8071 False Tread Cap,
the 3700 baluster and
the 3811 shoe*

STAIR PART TERMS

ILLUSTRATED AND DEFINED TERMS



1. Universal Newel (5" Top Block)

Choose this newel for a starting newel or first floor newel. Choose a 48" when your rake is less than 33" and 54" or 56" when your rake height is 34" or larger. This newel can also be used on a balcony when 5" block is desired.

2. Universal Pin Top Newel w/ Starting Easing (xx10)

Typically, a 48" newel is used in this scenario.

3. Crown System Wood Baluster

When using two balusters per tread, use 35" and 39".
When using three balusters per tread, use 35", 37-1/2" and 44" (42" for 1-1/4"). These balusters are designed to be cut from the top when installed.

4. Three Length Wood Baluster

For 34" or 35" rake heights: use a 34" and 38" baluster when using two balusters per tread. When using three balusters per tread, use 34", 38" and 42". For 35" to 38" rake heights: use a 38" and 42" baluster when using two balusters per tread. When using three balusters per tread, use 38" and two 42".

5. Second Floor Landing Newel (11" Top Block)

Second floor or balcony where fittings will not be used.

6. Intermediate Landing Newel (14-1/2" Top Block)

Use at landings where the stair continues up another flight of stairs and fittings are not being used.

7. Rosette

Used when the rail terminates into a wall. Available in various design including oval, round and square edge.

8. Universal Newel (5" Top Block) with Gooseneck (xx99)

Typically, a 54" or 56" newel is used in this scenario.

9. Half Newel

Can be used instead of rosettes when the rail terminates into the wall.

10. Iron Balusters

Available in hollow or solid. Profiles may vary and are available in 44". Select profiles available in 36" for balconies.

11. Box Newels

An alternative to traditional turned post.

12. Box Newel with gooseneck (xx99)

Box newels can be used on landings. A fitting allows the railing to hit above the trim.

13. Single Return Tread

Use when one side of the stair is open. Tread is reversible.

14. Double Return Tread

Use when both sides of the stair is open.



15. Riser

The vertical component of a stair that supports the tread.

16. Double End Starting Step

Also available in single end.

17. Volute Newel with Volute (Pictured: xx30)

Volute newels include a dowel for installation. Most installations require 42" balusters under a volute.

18. Universal Pin Top Newel with Turnout (Pictured: XX45)

A 43" newel can be used on a starting step under a volute or turnout.

19. Intermediate Pin Top Newel with Quarter Turn Gooseneck Cap and Easing (Pictured: xx65)

Fitting allows the railing to continue up another flight of stairs.

20. Intermediate Pin Top Newel with Tandem Cap Gooseneck (xx89)

Fitting allows the railing to continue straight at the landing.

21. Tandem Cap (xx20)

Fittings allows the railing to continue straight over a post.

22. Quarter Turn with Cap (xx21)

Fitting allows the railing to turn 90 degrees over a post.

23. Cable

A modern balustrade option.

24. "S" Turn Fitting (Pictured: xx11SRH)

Fitting allows the railing to turn around a wall.

25. Kneewall

A framed wall that covers the treads and risers. Balusters or cable can be installed on a kneewall. Balusters will be shorter than standard stair installations. Select iron profiles available in 30" specifically for kneewall installations.

DESIGN YOUR OWN STAIR ONLINE

The following information will help you begin installation of an Over-the-Post Stair System, which is only for interior use. This list will allow the flexibility to comply with most building codes related to baluster spacing and handrail height. Always consult your local building codes before starting installation.

1. **Starting Step:** To be used with volute and turnout fittings. Length is determined from outside finished wall to outside finished wall. (see page 77)
2. **Treads:** Excluding the starting step, choose one tread for each step. Open-sided stairs require mitered return treads. Treads are available mitered on one side or both sides. For open-on-one-side stairs, add $1\frac{1}{8}$ " to the measured length between the finished walls and order the next longest standard length of tread. (see page 75)
3. **Risers:** The required number of risers will be one more than the number of treads chosen in No. 2. Do not choose a riser for the starting step. (see page 76)
4. **Skirtboards:** Skirtboards are used on both sides of the stairs, regardless of whether they are open or enclosed. Allow 13" per tread and round up to either 12' or 16' length. (Note, Crown Heritage Skirtboards are only available in 12' and 16' lengths) (see page 78)
5. **Landing Tread:** Choose enough landing tread for all landings and balconies. $5\frac{1}{4}$ " landing tread is used with $3\frac{1}{2}$ " newels. $3\frac{1}{4}$ " landing tread may be used with 3" newels. (page 76)
6. **Cove Moulding:** Choose enough footage to go under all landing tread and tread nosing, including tread returns. (page 78)
7. **Starting Fitting:** Choose from volute, turnout or starting easing. (pages 71-72)
8. **Starting Newel:** Choose either a volute newel or the shortest universal newel for the first floor. (pages 53-66)
9. **Intermediate Newel:** Choose the 56" intermediate landing newel for two-rise applications where the newel will drape two rises. Choose the 72" newel if more than two rises are being draped. If the intermediate newel will not be draped, but is face mounted, the 48" newel may be used. (pages 53-66)
10. **Balcony Newel:** Choose the shortest universal newel for flush mount installations or the 48" length when the newel will be draped or mounted below the floor surface. (pages 53-66)
11. **Level Run:** A universal newel should be used at least every eight feet of balcony run. At the corner of the balcony, use a quarter-turn cap over each newel. The 43" universal newel may be used for flush mounts. The 48" universal newel should be used if a draped installation is desired. (pages 53-66)
12. **Half Newel or Rosette:** For the best installation, choose a half newel, which matches the other newels on the job. Alternately, choose a round rosette for all level rail connections and an oval rosette for all angle rail connections. (page 74)
13. **Hardware:** For a sturdy installation, choose the patented Newel Mounting Kit #3072. Choose the appropriate newel mounting hardware for each newel post. (pages 79)
14. **Balusters for Volutes and Turnouts:** Four or six $1\frac{1}{4}$ " balusters and four or five $1\frac{3}{4}$ " balusters are required under the volute. Turnouts require two $1\frac{1}{4}$ " and one $1\frac{3}{4}$ " balusters. For 30" rake heights use 38" or $37\frac{1}{2}$ " balusters under the volute and use a 42" or 44" baluster under turnouts. For 34" rake heights, use a 42" baluster under volutes and turnouts. When using $1\frac{1}{4}$ " balusters, choose the 42" baluster. When using $1\frac{3}{4}$ " balusters, choose the 44" baluster.
Warning: Rake heights over 35" may result in the balusters not being long enough. (pages 53-66)
15. **Balusters for Starting Easing With Cap:** Use one 38" or 39" baluster under a starting easing if your rake height is 30". Use a 42" baluster if your rake rail height is 34". (pages 53-66)
16. **Rake Balusters for 34" Rake Heights (3-length System):** When using two balusters per tread, use the 34" baluster as the first baluster and the 38" baluster as the second baluster. When using three balusters on a tread, use the 34" baluster as the first baluster, a 38" second baluster and a 42" third baluster on the tread. The 38" and 42" balusters will require the bottom of the baluster to be trimmed. (page 53-66)
17. **Rake Balusters for 34" Rake Heights (the Crown System):** When using two balusters per tread, use the 35" baluster as the first baluster and the 39" baluster as the second baluster. When using $1\frac{1}{4}$ " balusters, choose the 35", 37" and 42" balusters unless you have chosen the 5016—then use the 36", 39" and 42" balusters. When using $1\frac{3}{4}$ " balusters, choose the 35", 37" and 44" balusters. The Crown System balusters are designed to be trimmed at the top of the balusters. (page 53-66)
18. **Fittings for Landings:** Choose the correct fitting for each newel. Half newels require an opening cap, which will be cut on the job. (pages 71-72)
19. **Handrail:** Choose the appropriate lineal footage of handrail. 13" per step is the average length needed. Our handrail comes factory shrink-wrapped to ensure the product stays clean and remains undamaged. (page 73)
20. **Shoerail:** If shoerail is desired, then choose the appropriate lineal footage. 13" per step is the average length needed. Our shoerail comes factory shrink-wrapped to ensure the product stays clean and remains undamaged. (page 73)
21. **Fillet:** Fillet is shipped **tacked into** all plowed handrails and shoerails. (page 73)
22. **Wood Plug:** A 1" wood plug is needed for each hole bored in the newel. (page 79)
23. **Dowel Screw:** Where the screw method of installation is being used, choose one dowel screw for each baluster except for those balusters being used in a shoerail. This is a recommended, but optional, method of installation. (page 79)
24. **Bracket:** If desired, choose one bracket for each tread. (page 78)

POST-TO-POST TAKE-OFF GUIDE

The following information will help you begin installation of a Post-to-Post Stair System, which is only for interior use. This list will allow the flexibility to comply with most building codes related to baluster spacing and handrail height. Always consult your local building codes before starting installation.

1. **Treads:** Excluding the starting step, choose one tread for each step. Open-sided stairs require mitered return treads. Treads are available mitered on one side or both sides. For open-on-one-side stairs, add 1¹/₈" to the measured length between the finished walls and order the next longest standard length of tread. (page 75)
2. **Risers:** The required number of risers will be one more than the number of treads chosen in No. 2. Do not choose a riser for the starting step. (page 76)
3. **Skirtboards:** Skirtboards are used on both sides of the stairs, regardless of whether they are open or enclosed. Allow 13" per tread and round up to either 12' or 16' length. (Note, Crown Heritage skirtboards are only available in 12' and 16' lengths). (page 78)
4. **Landing Tread:** Choose enough landing tread for all landings and balconies. 5¹/₄" landing tread is used with 3¹/₂" newels. 3³/₄" landing tread may be used with 3" newels. (page 76)
5. **Cove Moulding:** Choose enough footage to go under all landing tread and tread nosing, including tread returns. (page 78)
6. **Starting Newel:** Choose the 48" universal newel, if available, for 30" rake rail heights and the 54" or 56" lengths for 34" rake rail heights. (pages 53-66)
7. **Intermediate Newel:** Choose the appropriate intermediate landing newel with a 14¹/₂" top block when not using a fitting and a 5" top block. (pages 53-66)
8. **Second-floor Newel:** Choose the appropriate second-floor landing newel with an 11" top block if fittings are not being used. If fittings are being used, choose a 5" top block universal newel. (pages 53-66)
9. **Balcony Newel:** Choose the shortest universal newel for flush mount installations or the 48" length when the newel will be draped or mounted below the floor surface. (pages 53-66)
10. **Half Newel or Rosette:** For the best installation, choose a half newel, which matches the other newels on the job. Alternately, choose a round rosette for all level rail connections and an oval rosette for all angle rail connections. (page 74)
11. **Hardware:** Choose the appropriate newel mounting hardware for each newel post. (pages 79)
12. **Rake Balusters for 34" Rake Heights (3-length System):** When using two balusters per tread, use the 34" baluster as the first baluster and the 38" baluster as the second baluster. When using three balusters on a tread, use the 34" baluster as the first baluster, a 38" second baluster and a 42" third baluster on the tread. The 38" and 42" balusters will require the bottom of the baluster to be trimmed. (page 53-66)
13. **Rake Balusters for 34" Rake Heights (the Crown System):** When using two balusters per tread, use the 35" baluster as the first baluster and the 39" baluster as the second baluster. When using 1¹/₄" balusters, choose the 35", 37", and 42" balusters unless you have chosen the 5016—then use the 36", 39" and 42" balusters. When using 1³/₄" balusters, choose the 35", 37" and 44" balusters. The Crown System balusters are designed to be trimmed at the top of the balusters. (page 53-66)
14. **Handrail:** Choose the appropriate lineal footage of handrail. 13" per step is the average length needed. Our handrail comes factory shrink-wrapped to ensure the product stays clean and remains undamaged. (page 73)
15. **Shoerail:** If shoerail is desired, then choose the appropriate lineal footage. 13" per step is the average length needed. Our shoerail comes factory shrink-wrapped to ensure the product stays clean and remains undamaged. (page 73)
16. **Fillet:** Fillet is shipped tacked into all plowed handrails and shoerails. (page 73)
17. **Wood Plug:** A 1" wood plug is needed for each hole bored in the newel. (page 79)
18. **Dowel Screw:** Where the screw method of installation is being used, choose one dowel screw for each baluster, except for those balusters being used in a shoerail. This is a recommended, but optional, method of installation. (page 79)
19. **Bracket:** If desired, choose one bracket for each tread. (page 78)
20. **Handrail Hardware:** Choose a #3078 Rail and Post Fastener or a #3075 Flush Mount Kit for each newel. (page 74)



Downloading our CAD drawings is easy.

Please note: Crown Heritage is committed to lead the industry with style. To support this commitment, product line improvements, changes and additions are a regular occurrence. Before making your final purchasing decision, please consult your Crown Heritage sales person or contact a customer service representative at 1-800-745-5931 for up to date information on species, colors and availability.

Iron Balusters & Newels				Ash Gray	Satin Nickel	Rubbed Bronze	Rubbed Copper	Satin Black
pg.	Model	Description	Size					
11	1000	Hammered Plain Baluster	14 x 44			X	X	
11	1001	Hammered 1 Basket Baluster	14 x 44			X	X	
11	1002	Hammered 2 Basket Baluster	14 x 44			X	X	
17	1060	Hammered Plain Baluster	14 x 44			X	X	
17	1061	Hammered 1 Knuckle Baluster	14 x 44			X	X	
17	1062	Hammered 2 Knuckle Baluster	14 x 44			X	X	
17	1068	Ham'd Plain w/Scroll Baluster	14 x 44			X		
18	1070	Hammered Round Bar Baluster	12 x 44			X		
18	1071	Ham'd Round 1 Knuckle Baluste	12 x 44			X		
18	1072	Ham'd Round 2 Knuckle Baluste	12 x 44			X		
18	1074	Large Ham'd Round Bar Baluste	16 x 44			X		
11	1090	Hammered Plain Newel	30 x 48			X		
5	1101	1 Twist Baluster	12 x 44			X		
5	1102	2 Twist Baluster	12 x 44			X		
5	1103	22" Twist Baluster	12 x 44			X		
6	1121	Twist 1 Basket Baluster	12 x 44			X		
6	1122	Twist 2 Basket Baluster	12 x 44			X		
6	1190	Twist Newel	30 x 48			X		
9	1700	Plain Square Bar Baluster	12 x 44			X		
9	1701	Plain Square Bar 1 Knuckle Bal	12 x 44			X		
9	1702	Plain Square Bar 2 Knuckle Bal	12 x 44			X		
9	1707	Plain Squiggle Baluster	14 x 44			X		
8	2101	Hollow 1 Twist Baluster	19 x 44		X	X		
8	2102	Hollow 2 Twist Baluster	19 x 44		X	X		
8	2121	Hollow Twist 1 Basket Baluster	19 x 44		X	X		
8	2122	Hollow Twist 2 Basket Baluster	19 x 44		X	X		
8	2700	Plain Square Bar Baluster	19 x 44		X	X		
8	2701	1 Knuckle Baluster	19 x 44		X	X		
8	2702	2 Knuckle Baluster	19 x 44		X	X		
8	2708	Hollow Balustr w/ Large Scroll	19 x 44		X	X		
15	3060	Hollow Hamrd Plain Baluster	14 x 44		X	X	X	
6	3101	1 Twist Baluster	12 x 36			X		
7	3101	1 Twist Baluster	12 x 30			X		
5	3101	1 Twist Baluster	12 x 44	X	X	X	X	
6	3102	2 Twist Baluster	12 x 36			X		
7	3102	2 Twist Baluster	12 x 30			X		
5	3102	2 Twist Baluster	12 x 44	X	X	X	X	
6	3121	Twist 1 Basket Baluster	12 x 36			X		
7	3121	Twist 1 Basket Baluster	12 x 30			X		
6	3121	Twist 1 Basket Baluster	12 x 44	X	X	X	X	
6	3122	Twist 2 Basket Baluster	12 x 36			X		
7	3122	Twist 2 Basket Baluster	12 x 30			X		
6	3122	Twist 2 Basket Baluster	12 x 44	X	X	X	X	
16	3201	Hollow Feather Baluster	14 x 44			X		
16	3202	Hollow Split Feather Baluster	14 x 44			X		
13	3301	Hollow 1 Ribbon Baluster	12 x 44			X		
13	3302	Hollow 2 Ribbon Baluster	12 x 44			X		
13	3321	1 Basket 2 Ribbons Baluster	12 x 44			X		
13	3322	1 Ribbon 2 Baskets Baluster	12 x 44			X		
19	3401	1 Ring Baluster	12 x 44			X		
19	3402	Double Ring Baluster	12 x 44			X		
9	3404	Double Bar Baluster	12 x 44			X		
19	3406	1 Diamond Baluster	12 x 44			X		

Iron Balusters & Newels				Ash Gray	Satin Nickel	Rubbed Bronze	Rubbed Copper	Satin Black
pg.	Model	Description	Size					
20	3408	Oval Baluster	12 x 44					X
20	3409	Rectangle Baluster	12 x 44					X
20	3410	Marquis Baluster	12 x 44					X
15	3501	Hollow Spoon 1 Knuckle Balustr	14 x 44			X	X	X
15	3502	Hollow Spoon 2 Knuckle Balustr	14 x 44			X	X	X
15	3531	Hollow Spoon w/ Basket Balustr	14 x 44			X	X	X
18	3600	Plain Round Bar Baluster	12 x 44			X		X
9	3700	Plain Square Bar Baluster	12 x 36			X		X
9	3700	Plain Square Bar Baluster	12 x 44	X	X	X	X	X
9	3701	Plain Baluster w/ 1 Knuckle	12 x 44	X	X	X	X	X
9	3702	Plain Baluster w/ 2 Knuckles	12 x 44	X	X	X	X	X
10	3708	Plain Baluster w/ Large Scroll	12 x 44			X	X	X
20	3790	Plain Hollow Newel	30 x 48			X		X
9	4700	Plain Square Bar Baluster	14 x 44			X	X	

Rails and Fillets				Beech	Hickory	Maple	Poplar	Red Oak	White Oak	Yellow Pine
pg.	Model	Description								
73	6000P	Handrail Plwd w/fillet 1-1/4"				X	X	X	X	
73	6001P	Handrail Plwd w/fillet 1-3/4"				X	X	X	X	
73	6002	Handrail 1-5/8 x 2-13/16"				X	X	X	X	
73	6006	Shoerail Plwd w/fillet 1-3/4"		X		X	X	X		
73	6008	Shoerail Plwd w/fillet 1-1/4"						X		
73	6009	Shoerail Plwd w/fillet 1-3/4"						X		
73	6010	Handrail FJ 2-1/4 x 2-3/8"		X				X	X	X
73	6010B	Handrail Bending w/ Mould 7 pc						X	X	
73	6010P	Handrail FJ Plowed		X				X	X	X
73	6010SC	Handrail Solid Cap		X		X	X	X	X	
73	6010SCP	Handrail Plowed Solid Cap				X		X		
73	6010ST	Handrail Solid Top		X	X			X		
73	6010STP	Handrail Plowed Solid Top		X				X		
74	6040	Wallrail 1-3/4 x 1-5/8"		X			X	X	X	
74	6042	Wallrail 2-1/4 x 1-9/32"		X		X		X		
73	6100S	Handrail Solid						X		
73	6106	Shoerail Plwd w/fillet 1-1/4"		X						
73	6203	Handrail 1-5/8 x 5-1/2"						X		
73	6206	Shoerail Plwd w/fillet 1-5/8"		X						
73	6210	Handrail FJ 2-5/8 x 2-3/8"						X	X	
73	6210B	Handrail Bending w/Bendg Mou						X	X	
73	6210P	Handrail FJ Plwd w/fill 1-3/4"					X	X	X	X
73	6210SC	Handrail Solid Cap		X		X	X	X	X	
73	6210SCP	Handrail Plw Solid Cap w/fill		X		X		X		
73	6210ST	Handrail Solid Top		X				X		
73	6210STP	Handrail Plowed Solid Top						X		
73	6245	Shoerail Plwd w/fillet 1-3/4"						X		
73	6310	Handrail 2-5/8 x 2-1/4"						X		
73	6310B	Handrail Bending w/Bendg Mou						X		
73	6310S	Handrail Solid				X		X		
73	6310SP	Handrail Plowed Solid				X		X		
73	6310ST	Handrail Solid Top						X		
73	6310STP	Handrail Plowed Solid Top						X		
73	6519ST	Handrail Solid Top				X		X		
73	6519STP	Handrail Plowed Solid Top		X		X		X		
73	6602	Handrail 1-5/8 x 2-1/4"				X	X	X	X	
73	6715	Handrail Solid Top						X	X	
73	6840	Handrail Solid Top				X	X	X	X	
73	6840P	Handrail Plowed Solid Top						X	X	

SUFFIXES USED

B	Octagonal	LH	Left Hand
B	Ball Top for Newels	MR	Mitered Return
B	Bending for Rail	NCT	No Cap and Trim
B	Base	P	Plowed
BM	Bending Mold	R	Rope
C	Colonial Ball Top	RH	Right Hand
DMR	Double Miter Return	R	Ring Top
D	Reed	S	Spade Top for Newels, 3 Layer Solid for Handrail
F	Flute	SC	Solid Cap Engineered for Rail
H	Half	ST	Solid Top Rail
LH	Left Hand	T	Twist

Wood Newels				Beech	Hickory	Maple	Poplar	Primed	Red Oak	White Oak	Yellow Pine
pg.	Model	Description	Size								
60	3010	Univrsl Newel	3.5 x 43			X	X	X			
60	30108	Univrsl Newel Oct	3.5 x 43					X			
60	3010F	Univrsl Newel Flute	3.5 x 43			X	X	X			
60	3010T	Univrsl Newel Twist	3.5 x 43			X	X	X			
60	3012	Rake Newel	3 x 43			X	X	X			
60	3013	Volute Newel	3.5 x 43			X		X			
60	30138	Volute Newel Oct	3.5 x 43					X			
60	3013F	Volute Newel Flute	3.5 x 43			X	X	X			
60	3013T	Volute Newel Twist	3.5 x 43			X	X	X			
60	3014	Univrsl Newel	3.5 x 48			X	X	X	X		
60	30148	Univrsl Newel Oct	3.5 x 48					X			
60	3014F	Univrsl Newel Flute	3.5 x 48			X	X	X			
60	3014T	Univrsl Newel Twist	3.5 x 48			X	X	X			
60	3015	2nd Floor Lndg Newel	3.5 x 56			X		X			
60	30158	2nd Floor Lndg Newel Oct	3.5 x 56					X			
60	3015F	2nd Floor Lndg Newel Flute	3.5 x 56			X	X	X			
60	3015T	2nd Floor Lndg Newel Twist	3.5 x 56			X	X	X			
60	3018	Winder Newel	3.5 x 72			X	X	X			
60	30188	Winder Newel Oct	3.5 x 72					X			
60	3018F	Winder Newel Flute	3.5 x 72			X	X	X			
60	3018T	Winder Newel Twist	3.5 x 72			X	X	X			
60	3040	Univrsl Newel	3.5 x 48			X	X	X			
60	30408	Univrsl Newel Oct	3.5 x 48					X			
60	3040F	Univrsl Newel Flute	3.5 x 48			X	X	X			
60	3040T	Univrsl Newel Twist	3.5 x 48			X	X	X			
60	3042	Univrsl Newel	3.5 x 56			X	X	X			
60	30428	Univrsl Newel Oct	3.5 x 56					X			
60	3042F	Univrsl Newel Flute	3.5 x 56			X	X	X			
60	3042T	Univrsl Newel Twist	3.5 x 56			X	X	X			
60	3045	2nd Floor Lndg Newel	3.5 x 58			X	X	X			
60	30458	2nd Floor Lndg Newel Oct	3.5 x 58					X			
60	3045F	2nd Floor Lndg Newel Flute	3.5 x 58			X	X	X			
60	3045T	2nd Floor Lndg Newel Twist	3.5 x 58			X	X	X			
60	3046	Intermediate Newel	3.5 x 72					X			
60	30468	Intermediate Newel Oct	3.5 x 72					X			
60	3046F	Intermediate Newel Flute	3.5 x 72			X	X	X			
60	3046T	Intermediate Newel Twist	3.5 x 72			X	X	X			
60	3047	Intermediate Newel	3.5 x 58			X	X	X			
60	30478	Intermediate Newel Oct	3.5 x 58					X			
60	3047F	Intermediate Newel Flute	3.5 x 58			X	X	X			
60	3047T	Intermediate Newel Twist	3.5 x 58			X	X	X			
60	3055	Winder Newel	3.5 x 72			X		X			
60	30558	Winder Newel Oct	3.5 x 72					X			
60	3055F	Winder Newel Flute	3.5 x 72			X	X	X			
60	3055T	Winder Newel Twist	3.5 x 72			X	X	X			
54	3209	Rake Newel	3 x 43			X	X	X			
54	3214	Universal Newel	3 x 48			X	X	X			
54	3215	2nd Floor Lndg Newel	3 x 58			X	X	X			
54	3240	Universal Newel	3 x 48			X	X	X			
54	3242	Universal Newel	3 x 54			X	X	X			
54	3245	2nd Floor Lndg Ball Top Newel	3 x 58			X	X	X			
54	3246	Intermediate Newel	3 x 58			X	X	X			
54	3314	Universal Newel	3.5 x 48			X	X	X			
54	3315	2nd Floor Lndg Newel	3.5 x 56			X	X	X			
54	3340	Universal Newel	3.5 x 48			X	X	X			
54	3342	Universal Newel	3.5 x 56			X	X	X			
54	3345	2nd Floor Lndg Ball Top Newel	3.5 x 56			X	X	X			
66	4000	S4S Newel	3.5 x 48	X		X	X	X	X		
66	4001	S4S Newel	3.5 x 56	X		X	X	X	X		
66	4002	4 X 4 S4S Newel	4 x 48			X	X	X	X		
66	4003	4 X 4 S4S Newel	4 x 56			X	X	X	X		
62	4004	Hampton Mushrm Top Newel	3.5 x 48	X		X	X	X			
62	4004B	Hampton Ball Top Newel	3.5 x 48			X	X	X			
62	4004S	Hampton Spade Top Newel	3.5 x 48			X	X	X			
62	4005	Hampton Mushrm Top Newel	3.5 x 56	X		X	X	X			
62	4005B	Hampton Ball Top Newel	3.5 x 56	X		X	X	X			
62	4005S	Hampton Spade Top Newel	3.5 x 56	X		X	X	X			
62	4006	Hampton Mushrm Top Newel	3.5 x 72	X		X	X	X			
62	4006B	Hampton Ball Top Newel	3.5 x 72	X		X	X	X			
62	4006S	Hampton Spade Top Newel	3.5 x 72	X		X	X	X			
66	4007	Univrsl Newel w/ Panel	3.5 x 48					X	X		
66	4008	Intermediate Newel w/ Panel	3.5 x 56					X	X		
64	4010	Univrsl Newel	3 x 43	X		X	X	X			
64	4011	Volute / Turnout	3 x 43	X		X	X	X			
64	4013	Rake Newel	3 x 43	X		X	X	X	X		
64	4014	Univrsl Lndg Newel	3 x 48	X		X	X	X	X		
64	4015	2nd Floor Lndg Newel	3 x 58	X		X	X	X			
64	4018	Winder Newel	3 x 72	X				X			

Wood Newels				Beech	Hickory	Maple	Poplar	Primed	Red Oak	White Oak	Yellow Pine
pg.	Model	Description	Size								
64	4040	Univrsl Mushrm Top Newel	3 x 48	X		X	X	X	X	X	X
64	4040B	Univrsl Ball Top Newel	3 x 48	X		X	X	X	X		
64	4041	Knee Wall Mushrm Top Newel	3 x 48			X		X			
64	4041B	Knee Wall Ball Top Newel	3 x 48			X		X			
64	4042	Univrsl Mushrm Top Newel	3 x 54	X		X	X	X	X		
64	4042B	Univrsl Ball Top Newel	3 x 54	X		X	X	X	X		
64	4045	2nd Floor Lndg Mush Top Newe	3 x 58	X		X	X	X	X		
64	4045B	2nd Floor Lndg Ball Top Newel	3 x 58	X		X	X	X	X		
64	4046	Intermediate Mushrm Top Newe	3 x 72	X		X	X	X			
64	4046B	Intermediate Ball Top Newel	3 x 72	X		X	X	X			
64	4047	Intermediate Mushrm Top Newe	3 x 54	X		X	X	X			
64	4047B	Intermediate Ball Top Newel	3 x 54	X		X	X	X			
64	4050	Starting Newel	2.25 x 43	X		X	X	X			
64	4055	Winder Mushrm Top Newel	3 x 72	X		X	X	X			
64	4055B	Winder Ball Top Newel	3 x 72	X		X	X	X			
64	4060	Starting Newel	2.75 x 43	X		X	X	X			
45	4076	Box Newel	3.5 x 58	X	X	X	X	X	X	X	X
45	4077	Box Newel 3.5 with Bevel Cap	3.5 x 56			X		X	X		
46	4082	Flute Box Newel	4.25 x 56.5			X		X			
46	4083	Panel Box Newel	4.25 x 56.5					X			
65	4086	Starting Newel	3 x 43.5	X				X			
65	4087	2nd Floor Lndg Newel	3 x 60	X				X			
65	4088	2nd Floor Lndg Newel	3 x 68.5	X				X			
45	4091	Box Newel	6.25 x 55	X	X	X	X	X	X	X	X
46	4092	Flute Box Newel	7.5 x 56			X		X	X		
46	4093	Panel Box Newel	7.5 x 56			X		X	X		
47	4094	Primed Box Newel	4 x 58			X	X				
47	4094F	Primed Box Newel - Flute	4 x 58					X			
49	4094FNCT	Flute Prm Box Newel NoCap&T	4 x 58					X			
49	4094NCT	Primed Box Newel No Cap & Tri	4 x 58					X	X		
47	4094NS	Primed Box Newel - No Stain	4 x 58					X			
47	4094NSF	Prime Box Newel-No Stain&Flut	4 x 58					X			
47	4095	Primed Box Newel	5 x 58			X	X				
47	4095F	Primed Box Newel - Flute	5 x 58					X			
49	4095FNCT	Flute Prm Box Newel NoCap&T	5 x 58					X			
49	4095NCT	Primed Box Newel No Cap & Tri	5 x 58					X	X		
47	4095NS	Primed Box Newel - No Stain	5 x 58					X			
47	4095NSF	Prime Box Newel-No Stain&Flut	5 x 58					X			
46	4097	Recess Panel Box Newel	4.25 x 56.5			X	X	X	X		
46	4098	Recess Panel Box Newel	7.5 x 56.5			X	X	X	X		
65	4100	Newel S4S	3.5 x 48			X		X	X		
65	4101	Newel S4S	3.5 x 56			X		X	X		
66	4102	Newel S4S	3.5 x 48			X		X	X		
66	4103	Newel S4S	3.5 x 56			X		X	X		
66	4108	Univrsl Newel w/ Panel	3.5 x 48					X	X		
66	4109	Intermediate Newel w/ Panel	3.5 x 56					X	X		
66	4113	Univrsl Sq. Taper Newel	3.5 x 48					X	X	X	
66	4114	Intermediate Sq. Taper Newel	3.5 x 56					X			
66	4115	Univrsl Newel	3.5 x 48					X			
66	4116	Intermediate Newel	3.5 x 56					X			
45	4176	Box Newel	5 x 58					X			
45	4177	Box Newel	5 x 58					X			
65	4118	Univrsl Round Newel	3.25 x 48					X	X		
65	4119	Intermediate Round Newel	3.25 x 56					X	X		
66	4131	Profiled Univrsl Newel	3.5 x 48					X			
66	4431	4.5 Square Newel	3.5 x 48					X			
64	4180	Univrsl Mushrm Top Newel	3 x 48			X	X	X			
64	4180B	Univrsl Ball Top Newel	3 x 48	X		X	X	X			
64	4181	Knee Wall Mushrm Top Newel	3 x 48			X	X	X			
64	4181B	Knee Wall Ball Top Newel	3 x 48	X		X	X	X			
64	4182	Univrsl Mushrm Top Newel	3 x 56			X	X	X			
64	4182B	Univrsl Ball Top Newel	3 x 56	X		X	X	X			
64	4185	2nd Floor Lndg Newel	3 x 56			X	X	X			
64	4185B	2nd Floor Lndg Ball Top Newel	3 x 56	X		X	X	X			
64	4186	Winder Mushrm Newel	3 x 58			X	X	X			
64	4186B	Winder Ball Top Newel	3 x 58	X		X	X	X			
45	4191	Box Newel	8 x 56			X		X			
64	4195	Winder Mushroom Newel	3 x 72			X	X	X			
64	4195B	Winder Ball Top Newel	3 x 72	X		X	X	X			
62	4212	Rake Newel	3 x 43			X		X			
62	4270	Univrsl Hampton Newel	3.5 x 43			X	X	X			
62	42708	Univrsl Hampton Newel Oct	3.5 x 43					X			
62	4272	Volute Hampton Newel	3.5 x 41			X		X			
62	42728	Volute Hampton Newel Oct	3.5								

Please note: Crown Heritage is committed to lead the industry with style. To support this commitment, product line improvements, changes and additions are a regular occurrence. Before making your final purchasing decision, please consult your Crown Heritage sales person or contact a customer service representative at 1-800-745-5931 for up to date information on species, colors and availability.

Wood Newels

pg.	Model	Description	Size	Beech	Hickory	Maple	Poplar	Primed	Red Oak	White Oak	Yellow Pine
62	42758	Univrsl Lndg Hampton Newel O	3.5 x 56					X			
62	4278	Univrsl Lndg Hampton Newel	3.5 x 72			X			X		
62	42788	Univrsl Lndg Hampton Newel O	3.5 x 72						X		
66	4300	S4S Newel	3 x 43			X	X		X		
66	4301	S4S Newel	3 x 48	X		X	X		X	X	
66	4302	S4S Newel	3 x 58			X	X	X	X	X	
62	4500	Univrsl Hampton Newel	3.5 x 48	X		X	X		X	X	
62	45008	Univrsl Hampton Newel Oct	3.5 x 48						X		
62	4502	Univrsl Hampton Newel	3.5 x 56			X	X		X		
62	45028	Univrsl Hampton Newel Oct	3.5 x 56						X		
62	4503	2nd Floor Lndg Hampton Newel	3.5 x 56	X	X	X		X			
62	45038	2nd Floor Lndg Hampton Newel O	3.5 x 56						X		
62	4505	Winder Hampton Newel	3.5 x 72			X			X		
62	45058	Winder Hampton Newel Oct	3.5 x 72						X		
62	4507	2nd Floor Lndg Hampton Newel	3.5 x 48			X			X		
62	45078	2nd Floor Lndg Hampton Newel O	3.5 x 48						X		
62	4508	Intermediate Hampton Newel	3.5 x 58	X		X	X		X		
62	45088	Intermediate Hampton Newel Oct	3.5 x 58						X		
62	4664	Univrsl Hampton Newel	4.5 x 48						X		
62	4665	Univrsl Hampton Newel	4.5 x 56						X		
58	4810	Univrsl Newel	3.5 x 43						X		
58	48108	Univrsl Newel Oct	3.5 x 43						X		
58	4810D	Univrsl Newel Reed	3.5 x 43						X		
58	4812	Rake Newel	3 x 43						X		
58	4813	Volute Newel	3.5 x 48						X		
58	48138	Volute Newel Oct	3.5 x 48						X		
58	4813D	Volute Newel Reed	3.5 x 48						X		
58	4814	Univrsl Newel	3.5 x 48						X		
58	48148	Univrsl Newel Oct	3.5 x 48						X		
58	4814D	Univrsl Newel Reed	3.5 x 48						X		
58	4825	Landing Newel	3.5 x 56						X		
58	48258	Landing Newel Oct	3.5 x 56						X		
58	4825D	Landing Newel Reed	3.5 x 56						X		
58	4842	Univrsl Newel	3.5 x 56						X		
58	48428	Univrsl Newel Oct	3.5 x 56						X		
58	4842D	Univrsl Newel Reed	3.5 x 56						X		
58	4845	2nd Floor Lndg Newel	3.5 x 56						X		
58	48458	2nd Floor Lndg Newel Oct	3.5 x 56						X		
58	4845D	2nd Floor Lndg Newel Reed	3.5 x 56						X		
58	4866	Intermediate Newel	3.5 x 58						X		
58	48668	Intermediate Newel Oct	3.5 x 58						X		
58	4866D	Intermediate Newel Reed	3.5 x 58						X		
56	8510	Univrsl Newel Plain	3.5 x 43						X		
56	85108	Univrsl Newel Oct	3.5 x 43						X		
56	8510F	Univrsl Newel Flute	3.5 x 43						X		
56	8510R	Univrsl Newel Rope	3.5 x 43						X		
56	8512	Rake Newel	3 x 43						X		
56	8513	Volute Newel Plain	3.5 x 43						X		
56	85138	Volute Newel Oct	3.5 x 43						X		
56	8513F	Volute Newel Flute	3.5 x 43						X		
56	8513R	Volute Newel Rope	3.5 x 43						X		
56	8514	Univrsl Newel Plain	3.5 x 48						X		
56	85148	Univrsl Newel Oct	3.5 x 48						X		
56	8514F	Univrsl Newel Flute	3.5 x 48						X		
56	8514R	Univrsl Newel Rope	3.5 x 48						X		
56	8525	Landing Newel Plain	3.5 x 56						X		
56	85258	Landing Newel Oct	3.5 x 56						X		
56	8525F	Landing Newel Flute	3.5 x 56						X		
56	8525R	Landing Newel Rope	3.5 x 56						X		
56	8542	Univrsl Newel Plain	3.5 x 56						X		
56	85428	Univrsl Newel Oct	3.5 x 56						X		
56	8542F	Univrsl Newel Flute	3.5 x 56						X		
56	8542R	Univrsl Newel Rope	3.5 x 56						X		
56	8545	2nd Floor Lndg Newel Plain	3.5 x 56						X		
56	85458	2nd Floor Lndg Newel Oct	3.5 x 56						X		
56	8545F	2nd Floor Lndg Newel Flute	3.5 x 56						X		
56	8545R	2nd Floor Lndg Newel Rope	3.5 x 56						X		
56	8547	Intermediate Newel Plain	3.5 x 58						X		
56	85478	Intermediate Newel Oct	3.5 x 58						X		
56	8547F	Intermediate Newel Flute	3.5 x 58						X		
56	8547R	Intermediate Newel Rope	3.5 x 58						X		
55	9012	W'burg Univrsl Newel Plain	3.5 x 48						X		
55	9012F	W'burg Univrsl Newel Flute	3.5 x 48						X		
55	9012R	W'burg Univrsl Newel Rope	3.5 x 48						X		
55	9013	W'burg Volute Newel Plain	3.5 x 48						X		
55	9013F	W'burg Volute Newel Flute	3.5 x 48						X		
55	9013R	W'burg Volute Newel Rope	3.5 x 48						X		
55	9025	W'burg Lndg Newel Plain	3.5 x 56						X		

Wood Balusters

pg.	Model	Description	Size	Beech	Hickory	Maple	Poplar	Primed	Red Oak	White Oak	Yellow Pine
55	9025F	W'burg Lndg Newel Flute	3.5 x 56								X
55	9025R	W'burg Lndg Newel Rope	3.5 x 56								X
55	9043	W'burg Univrsl Newel Plain	3.5 x 56								X
55	9043F	W'burg Univrsl Newel Flute	3.5 x 56								X
57	1805	1800's Balustr Sq Top Plain	1.75 x 35						X	X	
57	1805	1800's Balustr Sq Top Plain	1.75 x 37.5						X	X	
57	1805	1800's Balustr Sq Top Plain	1.75 x 39						X	X	
57	1805	1800's Balustr Sq Top Plain	1.75 x 44						X	X	
57	18058	1800's Balustr Sq Top Oct	1.75 x 35						X	X	
57	18058	1800's Balustr Sq Top Oct	1.75 x 37.5						X	X	
57	18058	1800's Balustr Sq Top Oct	1.75 x 39						X	X	
57	18058	1800's Balustr Sq Top Oct	1.75 x 44						X	X	
57	1805D	1800's Balustr Sq Top Reed	1.75 x 35						X	X	
57	1805D	1800's Balustr Sq Top Reed	1.75 x 37.5						X	X	
57	1805D	1800's Balustr Sq Top Reed	1.75 x 39						X	X	
57	1805D	1800's Balustr Sq Top Reed	1.75 x 44						X	X	
57	1815	1800's Balustr Pin Top Plain	1.75 x 35						X	X	X
57	1815	1800's Balustr Pin Top Plain	1.75 x 37.5						X	X	X
57	1815	1800's Balustr Pin Top Plain	1.75 x 39						X	X	X
57	1815	1800's Balustr Pin Top Plain	1.75 x 44						X	X	X
57	18158	1800's Balustr Pin Top Oct	1.75 x 35						X	X	X
57	18158	1800's Balustr Pin Top Oct	1.75 x 37.5						X	X	X
57	18158	1800's Balustr Pin Top Oct	1.75 x 39						X	X	X
57	18158	1800's Balustr Pin Top Oct	1.75 x 44						X	X	X
57	1825	1800's Balustr Pin Top Plain	2.25 x 35						X		
57	1825	1800's Balustr Pin Top Plain	2.25 x 37.5						X		
57	1825	1800's Balustr Pin Top Plain	2.25 x 39						X		
57	1825	1800's Balustr Pin Top Plain	2.25 x 44						X		
59	2005	Carolina Balustr Sq Top Plain	1.75 x 34						X	X	
59	2005	Carolina Balustr Sq Top Plain	1.75 x 38						X	X	
59	2005	Carolina Balustr Sq Top Plain	1.75 x 42						X	X	
59	2005F	Carolina Balustr Sq Top Fluted	1.75 x 34						X		
59	2005F	Carolina Balustr Sq Top Fluted	1.75 x 38						X		
59	2005F	Carolina Balustr Sq Top Fluted	1.75 x 42						X		
59	20058	Carolina Balustr Sq Top Oct	1.75 x 34						X		
59	20058	Carolina Balustr Sq Top Oct	1.75 x 38						X		
59	20058	Carolina Balustr Sq Top Oct	1.75 x 42						X		
59	2005T	Carolina Balustr Sq Top Twist	1.75 x 34						X		
59	2005T	Carolina Balustr Sq Top Twist	1.75 x 38						X		
59	2005T	Carolina Balustr Sq Top Twist	1.75 x 42						X		
59	2006	Carolina Balustr Sq Top Plain	1.75 x 35				X	X	X		
59	2006	Carolina Balustr Sq Top Plain	1.75 x 37.5				X	X	X		
59	2006	Carolina Balustr Sq Top Plain	1.75 x 39				X	X	X		
59	2006	Carolina Balustr Sq Top Plain	1.75 x 44				X	X	X		
59	2006F	Carolina Balustr Sq Top Flute	1.75 x 35				X	X	X		
59	2006F	Carolina Balustr Sq Top Flute	1.75 x 37.5				X	X	X		
59	2006F	Carolina Balustr Sq Top Flute	1.75 x 39				X	X	X		
59	2006F	Carolina Balustr Sq Top Flute	1.75 x 44				X	X	X		
59	2006T	Carolina Balustr Sq Top Twist	1.75 x 35				X	X	X		
59	2006T	Carolina Balustr Sq Top Twist	1.75 x 37.5				X	X	X		
59	2006T	Carolina Balustr Sq Top Twist	1.75 x 39				X	X	X		
59	2006T	Carolina Balustr Sq Top Twist	1.75 x 44				X	X	X		
53	2011	Sierra Balustr Pin Top Plain	1.25 x 34				X	X	X	X	
53	2011	Sierra Balustr Pin Top Plain	1.25 x 38				X	X	X	X	
53	2011	Sierra Balustr Pin Top Plain	1.25 x 42				X	X	X	X	
53	2013	Sierra Balustr Pin Top Plain	1.25 x 35				X	X	X	X	
53	2013	Sierra Balustr Pin Top Plain	1.25 x 37.5				X	X	X	X	
53	2013	Sierra Balustr Pin Top Plain	1.25 x 39				X	X	X	X	
53	2013	Sierra Balustr Pin Top Plain	1.25 x 44				X	X	X	X	
59	2015	Carolina Balustr Pin Top Plain	1.75 x 34						X	X	
59	2015	Carolina Balustr Pin Top Plain	1.75 x 38						X	X	
59	2015	Carolina Balustr Pin Top Plain	1.75 x 42						X	X	
59	2015F	Carolina Balustr Pin Top Fluted	1.75 x 42						X		
59	20158	Carolina Balustr Pin Top Oct	1.75 x 34						X		
59	20158	Carolina Balustr Pin Top Oct	1.75 x 38						X		
59	20158	Carolina Balustr Pin Top Oct	1.75 x 42						X		
59	2015T	Carolina Balustr Pin Top Twist	1.75 x 34				X		X		
59	2015T	Carolina Balustr Pin Top Twist	1.75 x 38				X		X		
59	2015T	Carolina Balustr Pin Top Twist	1.75 x 42				X		X		
59	2016	Carolina Balustr Pin Top Plain	1.75 x 35				X	X	X	X	
59	2016	Carolina Balustr Pin Top Plain	1.75 x 37.5								

Wood Balusters				Beech	Hickory	Maple	Poplar	Primed	Red Oak	White Oak	Yellow Pine
pg.	Model	Description	Size								
59	2016F	Carolina Balustr Pin Top Fluted	1.75 x 37.5		X	X	X	X			
59	2016F	Carolina Balustr Pin Top Fluted	1.75 x 39		X	X	X	X			
59	2016F	Carolina Balustr Pin Top Fluted	1.75 x 42		X	X	X	X			
53	2025	Sierra Balustr Sq Top Plain	1.25 x 35		X	X	X	X			
53	2025	Sierra Balustr Sq Top Plain	1.25 x 37.5		X	X	X	X			
53	2025	Sierra Balustr Sq Top Plain	1.25 x 39		X	X	X	X			
53	2025	Sierra Balustr Sq Top Plain	1.25 x 42		X	X	X	X			
53	2105	Sierra Balustr Sq Top Plain	1.75 x 35					X	X		
53	2105	Sierra Balustr Sq Top Plain	1.75 x 37.5					X	X		
53	2105	Sierra Balustr Sq Top Plain	1.75 x 39					X	X		
53	2105	Sierra Balustr Sq Top Plain	1.75 x 44					X	X		
53	2111	Sierra Balustr Pin Top Plain	1.75 x 34		X	X	X	X			
53	2111	Sierra Balustr Pin Top Plain	1.75 x 38		X	X	X	X			
53	2111	Sierra Balustr Pin Top Plain	1.75 x 42		X	X	X	X			
53	2115	Sierra Balustr Pin Top Plain	1.75 x 35		X	X	X	X			
53	2115	Sierra Balustr Pin Top Plain	1.75 x 37.5		X	X	X	X			
53	2115	Sierra Balustr Pin Top Plain	1.75 x 39		X	X	X	X			
53	2115	Sierra Balustr Pin Top Plain	1.75 x 44		X	X	X	X			
61	5005	Hampton Balstr Sq Top	1.75 x 34					X	X		
61	5005	Hampton Balstr Sq Top	1.75 x 38					X	X		
61	5005	Hampton Balstr Sq Top	1.75 x 42					X	X		
61	50058	Hampton Balstr Sq Top Oct	1.75 x 34					X			
61	50058	Hampton Balstr Sq Top Oct	1.75 x 38					X			
61	50058	Hampton Balstr Sq Top Oct	1.75 x 42					X			
61	5006	Hampton Balstr Sq Top	1.75 x 31		X	X	X	X			
61	5006	Hampton Balstr Sq Top	1.75 X 36	X	X	X	X	X			
61	5006	Hampton Balstr Sq Top	1.75 x 42	X	X	X	X	X			
61	5007	Hampton Balstr Sq Top 1-5/8"	1.625 x 36					X			
61	5007	Hampton Balstr Sq Top 1-5/8"	1.625 x 42					X			
63	5010	Classic Balustr Tapered	1.50 x 36	X				X	X		
63	5010	Classic Balustr Tapered	1.50 x 39	X				X	X		
63	5010	Classic Balustr Tapered	1.50 x 42	X				X	X		
63	5015	Colonial Balstr Pin Top	1.25 x 34	X	X	X	X	X			
63	5015	Colonial Balstr Pin Top	1.25 x 38	X	X	X	X	X			
63	5015	Colonial Balstr Pin Top	1.25 x 42	X	X	X	X	X			
63	5016	Colonial Balstr Pin Top	1.25 x 31	X	X	X	X	X			
63	5016	Colonial Balstr Pin Top	1.25 x 36	X	X	X	X	X			
63	5016	Colonial Balstr Pin Top	1.25 x 39	X	X	X	X	X			
63	5016	Colonial Balstr Pin Top	1.25 x 42	X	X	X	X	X			
63	5016	Colonial Balstr Pin Top	1.25 x 45					X	X		
65	5060	Contemporary Balstr S4S Squar	1.25 x 36	X	X	X	X	X	X		
65	5060	Contemporary Balstr S4S Squar	1.25 x 42	X	X	X	X	X	X		
65	5061	Contemporary Balstr S4S Squar	1.25 x 36					X	X		
65	5061	Contemporary Balstr S4S Squar	1.25 x 42					X	X		
63	5067	Colonial Balstr Sq Top	1.25 x 34					X	X		
63	5067	Colonial Balstr Sq Top	1.25 x 38					X	X		
63	5067	Colonial Balstr Sq Top	1.25 x 42					X	X		
63	5068	Colonial Balstr Sq Top	1.25 x 31					X	X		
63	5068	Colonial Balstr Sq Top	1.25 x 35	X	X	X	X	X			
63	5068	Colonial Balstr Sq Top	1.25 x 37.5	X	X	X	X	X			
63	5068	Colonial Balstr Sq Top	1.25 x 39	X	X	X	X	X			
63	5068	Colonial Balstr Sq Top	1.25 x 42	X	X	X	X	X			
65	5070	Balstr Square Top	1.25 x 35					X	X	X	
65	5070	Balstr Square Top	1.25 x 37.5					X	X	X	
65	5070	Balstr Square Top	1.25 x 39					X	X	X	
65	5070	Balstr Square Top	1.25 x 42					X	X	X	
63	5090	Colonial Round Balstr	1 x 36					X			
63	5090	Colonial Round Balstr	1 x 42					X			
61	5106	Hampton Balstr Sq Top	1.75 x 35		X			X			
61	5106	Hampton Balstr Sq Top	1.75 x 37.5		X			X			
61	5106	Hampton Balstr Sq Top	1.75 x 39		X			X			
61	5106	Hampton Balstr Sq Top	1.75 x 44		X			X			
63	5141	Colonial Balstr Sq Top	1.25 x 34	X		X	X	X			
63	5141	Colonial Balstr Sq Top	1.25 x 38	X		X	X	X			
63	5141	Colonial Balstr Sq Top	1.25 x 42	X		X	X	X			
63	5142	Colonial Balstr Sq Top	1.25 x 31		X	X	X	X			
63	5142	Colonial Balstr Sq Top	1.25 x 35	X	X	X	X	X			
63	5142	Colonial Balstr Sq Top	1.25 x 37.5	X	X	X	X	X			
63	5142	Colonial Balstr Sq Top	1.25 x 39	X	X	X	X	X			
63	5142	Colonial Balstr Sq Top	1.25 x 42	X	X	X	X	X			
61	5200	Colonial Balstr Pin Top	1.25 x 34					X	X		
61	5200	Colonial Balstr Pin Top	1.25 x 38					X	X		
61	5200	Colonial Balstr Pin Top	1.25 x 42					X	X		
61	5205	Hampton Balstr Sq Top	1.25 x 36	X	X	X	X	X			
61	5205	Hampton Balstr Sq Top	1.25 x 42	X	X	X	X	X			
61	5300	Hampton Balstr Pin Top	1.75 x 34					X	X		
61	5300	Hampton Balstr Pin Top	1.75 x 38					X	X		

Wood Balusters				Beech	Hickory	Maple	Poplar	Primed	Red Oak	White Oak	Yellow Pine
pg.	Model	Description	Size								
61	5300	Hampton Balstr Pin Top	1.75 x 42					X	X		
61	53008	Hampton Balstr Pin Top Oct	1.75 x 34		X					X	
61	53008	Hampton Balstr Pin Top Oct	1.75 x 38		X					X	
61	53008	Hampton Balstr Pin Top Oct	1.75 x 42		X					X	
61	5301	Hampton Balstr Pin Top	1.75 x 35				X	X	X	X	
61	5301	Hampton Balstr Pin Top	1.75 x 37.5				X	X	X	X	
61	5301	Hampton Balstr Pin Top	1.75 x 39				X	X	X	X	
61	5301	Hampton Balstr Pin Top	1.75 x 44				X	X	X	X	
65	5360	Contemporary Balstr S4S Squar	1.75 X 36					X	X	X	X
65	5360	Contemporary Balstr S4S Squar	1.75 x 42					X	X	X	X
65	5361	Contemporary Balstr S4S Squar	1.75 X 36					X		X	
65	5361	Contemporary Balstr S4S Squar	1.75 x 42					X		X	
65	5370	Balstr Square Top	1.75 x 35					X	X	X	
65	5370	Balstr Square Top	1.75 x 37.5					X	X	X	
65	5370	Balstr Square Top	1.75 x 39					X	X	X	
65	5370	Balstr Square Top	1.75 x 44					X	X	X	
65	5380	Balstr Pin Top	1.75 x 35					X	X	X	
65	5380	Balstr Pin Top	1.75 x 37.5					X	X	X	
65	5380	Balstr Pin Top	1.75 x 39					X	X	X	
65	5380	Balstr Pin Top	1.75 x 44					X	X	X	
63	5891	Colonial Balstr Pin Top	1.25 x 34		X			X	X	X	
63	5891	Colonial Balstr Pin Top	1.25 x 36		X			X	X	X	
63	5891	Colonial Balstr Pin Top	1.25 x 39		X			X	X	X	
63	5891	Colonial Balstr Pin Top	1.25 x 42		X			X	X	X	
63	5892	Colonial Balstr Pin Top	1.25 x 34		X			X	X	X	
63	5892	Colonial Balstr Pin Top	1.25 x 36		X			X	X	X	
63	5892	Colonial Balstr Pin Top	1.25 x 39		X			X	X	X	
63	5892	Colonial Balstr Pin Top	1.25 x 42		X			X	X	X	
63	5894	Colonial Balstr Pin Top	1.25 x 34		X			X	X	X	
63	5894	Colonial Balstr Pin Top	1.25 x 36		X			X	X	X	
63	5894	Colonial Balstr Pin Top	1.25 x 39		X			X	X	X	
63	5894	Colonial Balstr Pin Top	1.25 x 42		X			X	X	X	
56	8515	Jefferson Balstr Pin Top Plain	1.75 x 35					X	X	X	
56	8515	Jefferson Balstr Pin Top Plain	1.75 x 37.5					X	X	X	
56	8515	Jefferson Balstr Pin Top Plain	1.75 x 39					X	X	X	
56	8515	Jefferson Balstr Pin Top Plain	1.75 x 44					X	X	X	
56	85158	Jefferson Balstr Pin Top Oct	1.75 x 35					X	X	X	
56	85158	Jefferson Balstr Pin Top Oct	1.75 x 37.5					X	X	X	
56	85158	Jefferson Balstr Pin Top Oct	1.75 x 39					X	X	X	
56	85158	Jefferson Balstr Pin Top Oct	1.75 x 44					X	X	X	
56	8515F	Jefferson Balstr Pin Top Flute	1.75 x 35					X	X	X	
56	8515F	Jefferson Balstr Pin Top Flute	1.75 x 37.5					X	X	X	
56	8515F	Jefferson Balstr Pin Top Flute	1.75 x 39					X	X	X	
56	8515F	Jefferson Balstr Pin Top Flute	1.75 x 44					X	X	X	
56	8515R	Jefferson Balstr Pin Top Rope	1.75 x 35					X	X	X	
56	8515R	Jefferson Balstr Pin Top Rope	1.75 x 37.5					X	X	X	
56	8515R	Jefferson Balstr Pin Top Rope	1.75 x 39					X	X	X	
56	8515R	Jefferson Balstr Pin Top Rope	1.75 x 44					X	X	X	
55	9005	W'burg Balstr Sq Top Plain	1.75 x 35					X	X	X	
55	9005	W'burg Balstr Sq Top Plain	1.75 x 37.5					X	X	X	
55	9005	W'burg Balstr Sq Top Plain	1.75 x 39					X	X	X	
55	9005	W'burg Balstr Sq Top Plain	1.75 x 44					X	X	X	
55	9005F	W'burg Balstr Sq Top Flute	1.75 x 35					X	X	X	
55	9005F	W'burg Balstr Sq Top Flute	1.75 x 37.5					X	X	X	
55	9005F	W'burg Balstr Sq Top Flute	1.75 x 39					X	X	X	
55	9005F	W'burg Balstr Sq Top Flute	1.75 x 44					X	X	X	
55	9005R	W'burg Balstr Sq Top Rope	1.75 x 35					X	X	X	
55	9005R	W'burg Balstr Sq Top Rope	1.75 x 37.5					X	X	X	
55	9005R	W'burg Balstr Sq Top Rope	1.75 x 39					X	X	X	
55	9005R	W'burg Balstr Sq Top Rope	1.75 x 44					X	X	X	
55	9015	W'burg Balstr Pin Top Plain	1.75 x 35					X	X	X	
55	9015	W'burg Balstr Pin Top Plain	1.75 x 37.5					X	X	X	
55	9015	W'burg Balstr Pin Top Plain	1.75 x 39					X	X	X	
55	9015	W'burg Balstr Pin Top Plain	1.75 x 44					X	X	X	
55	9015F	W'burg Balstr Pin Top Flute	1.75 x 35					X	X	X	
55	9015F	W'burg Balstr Pin Top Flute	1.75 x 37.5					X	X	X	
55	9015F	W'burg Balstr Pin Top Flute	1.75 x 39					X	X	X	
55	9015F	W'burg Balstr Pin Top Flute	1.75 x 44					X	X	X	
55	9015R	W'burg Balstr Pin Top Rope	1.75 x 35					X	X	X	
55	9015R	W'burg Balstr Pin Top Rope									

Crown[®] Heritage

No detail is too small, No element insignificant...

This is true craftsmanship.

This is Crown Heritage, one of the nation's largest stairparts manufacturer and provider of handcrafted solutions to fit every home with timeless designs.

2 Grandview Street
North Wilkesboro, NC 28659

www.crownheritage.com

AN OPERATING DIVISION OF ECMD, INC.



ECMD

100% Employee Owned

www.ecmd.com

CH 11.5.25 / 20,000

