

EastCoast[®]
Mouldings

THE BOOK OF STANDARD

EC MOULDING PROFILES

CROWN

DOOR & WINDOW

BASE

CHAIR RAIL

MISC.

BOARD & PANEL



The “EC” prefix, as a moulding pattern identifier, is the trusted symbol of high quality and consistent shapes within the millwork industry.

EastCoast[®]
Mouldings

The “EC” prefix was developed by EastCoast Mouldings as a way to create consistent standards and efficiency for modern mass production, while maintaining the highest quality.

Each profile is crafted with precision and the latest digital technology to be architecturally correct. This assures that each profile is recreated with quality, consistency and exact detail, allowing profiles to accurately match in the future for homeowners to easily repair or remodel the moulding profiles in a home.

More than 1,000 different moulding profiles are offered by EastCoast Mouldings.

Note: This catalog is produced to assist dealers, builders, architects, designers and home owners in choosing the moulding patterns best suited for almost any application. An end view of each profile is shown in full scale.

What is GEARScan?



Notice the use of a special, patent pending GEARScan barcode next to all the moulding profiles throughout this catalog. These unique barcodes will also be added to other forms of literature, displays and samples.

Users of our ECMDGears mobility app will be able to scan this code and get a real time display of the items associated with that profile showing the dealer's price without requiring each item to be selected individually.

ECMDGears users can view the availability of those related items and easily convert it into an order.

4 CROWN MOULDINGS

4-12 | CROWN
8-10 | DENTIL

13 DOOR & WINDOW TRIM

13-18	CASING	18-19	STOOL
13-14	BACK BAND	18	BRICK MOLD
16-17	APRON	21	MULLION
20	ROSETTE	21	STOP
20	PLINTH	21	ASTRAGAL

24 BASE MOULDINGS

24-30	BASE
24-25	BASE CAP
26	SHOE
27	QUARTER ROUND
28	COVE

31 CHAIR RAILS

31-33	CHAIR RAIL
33	CHAIR RAIL BACKER
34	PANEL MOULD

35 MISCELLANEOUS

35	FULL ROUND	36	PICTURE MOULD
35	HAND RAIL	36	SCREEN BEAD
36	CORNER	37	SHINGLE
36	CABINET MOULDING	37	CHAMFER
36	HALF ROUND	38	S4S

39 BOARD AND PANEL

39	S4S
40-41	PATTERN STOCK
42	PLYWOOD

42 PRODUCT SELECTION

42-45	MATCHING GUIDE
46-47	PRODUCT SELECTION

CROWN MOULDINGS

Including: Crown and Dentils

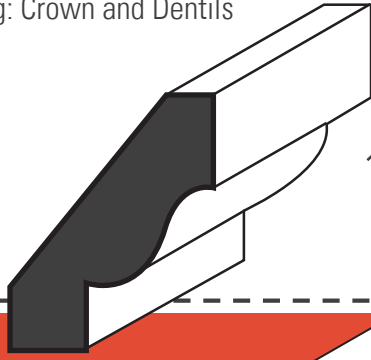

EC 60
1-3/4"
GEARScan
000060



EC 58
2-3/4"
GEARScan
000058

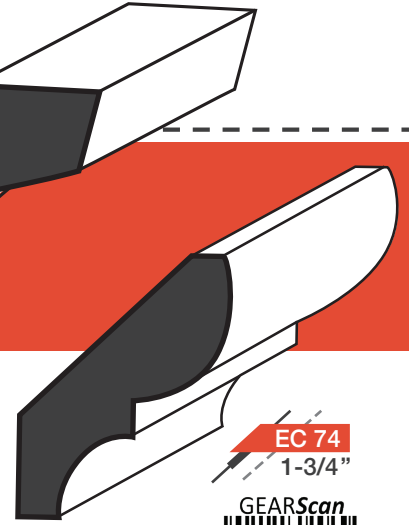

EC 74
1-3/4"
GEARScan
000074



EC 838
8-3/8"
GEARScan
000838



EC 550
5-1/2"
GEARScan
000550

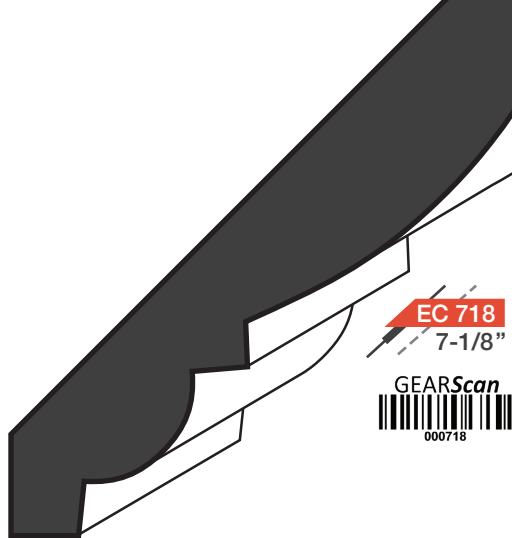

EC 718
7-1/8"
GEARScan
000718

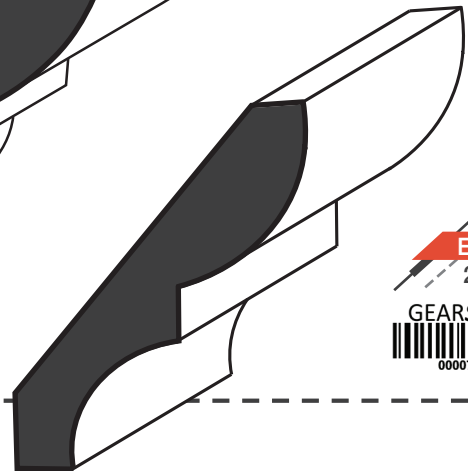

EC 70
2-3/4"
GEARScan
000070

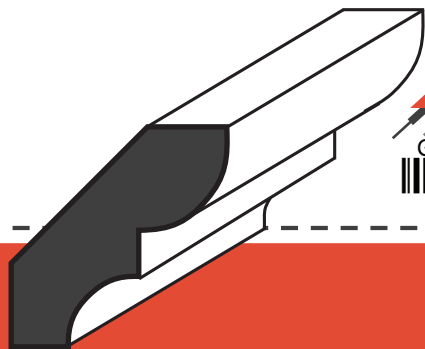

EC 75
1-5/8"
GEARScan
000075



EC 458
4-5/8"
GEARScan
000458



EC 814
8-1/4"
GEARScan
000814

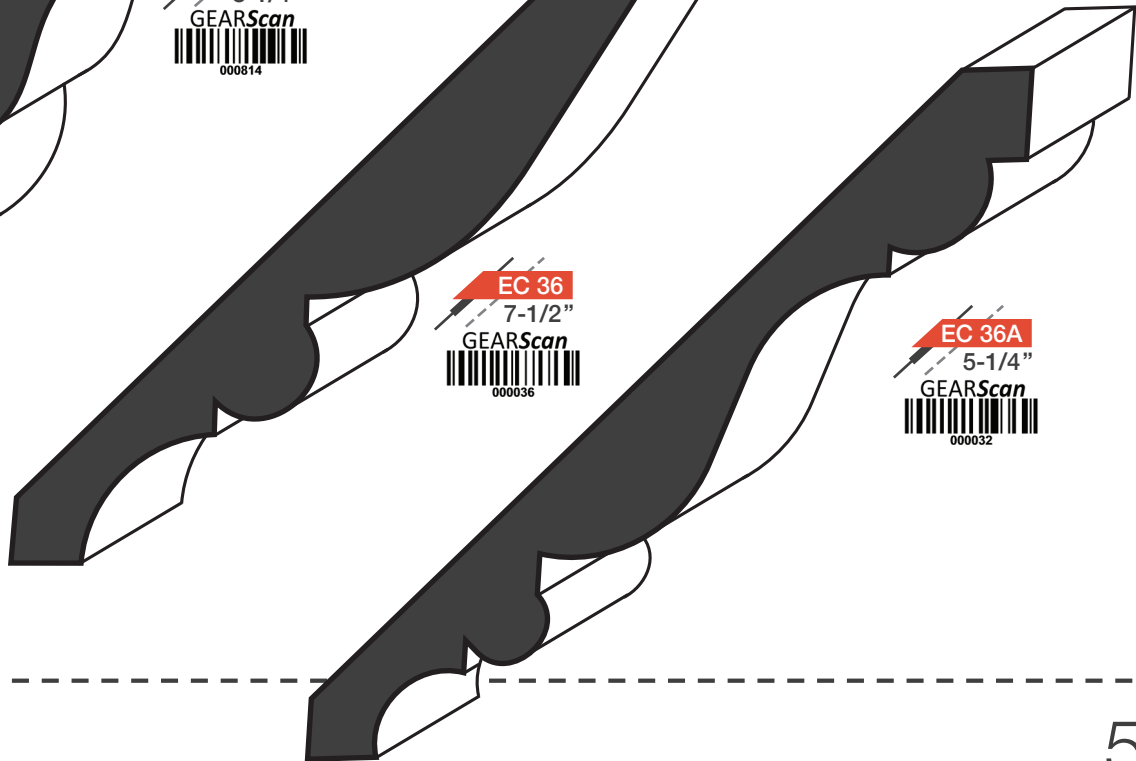

EC 36
7-1/2"
GEARScan
000036

EC 36A
5-1/4"
GEARScan
000032

CROWN MOULDINGS

Including: Crown and Dentils

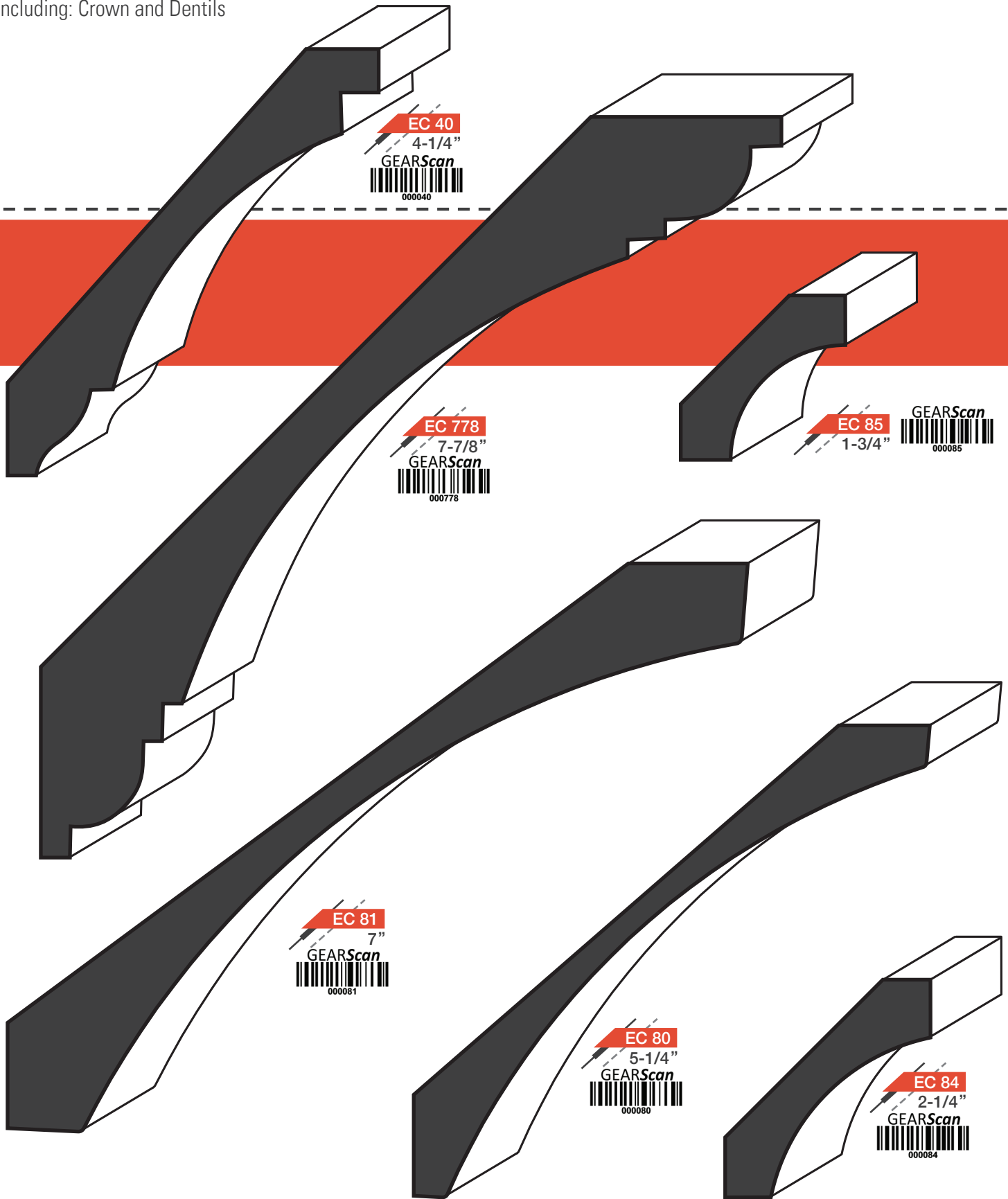

CROWN MOULDINGS

Including: Crown and Dentils

EC 39
5-3/8"
GEARScan
000039

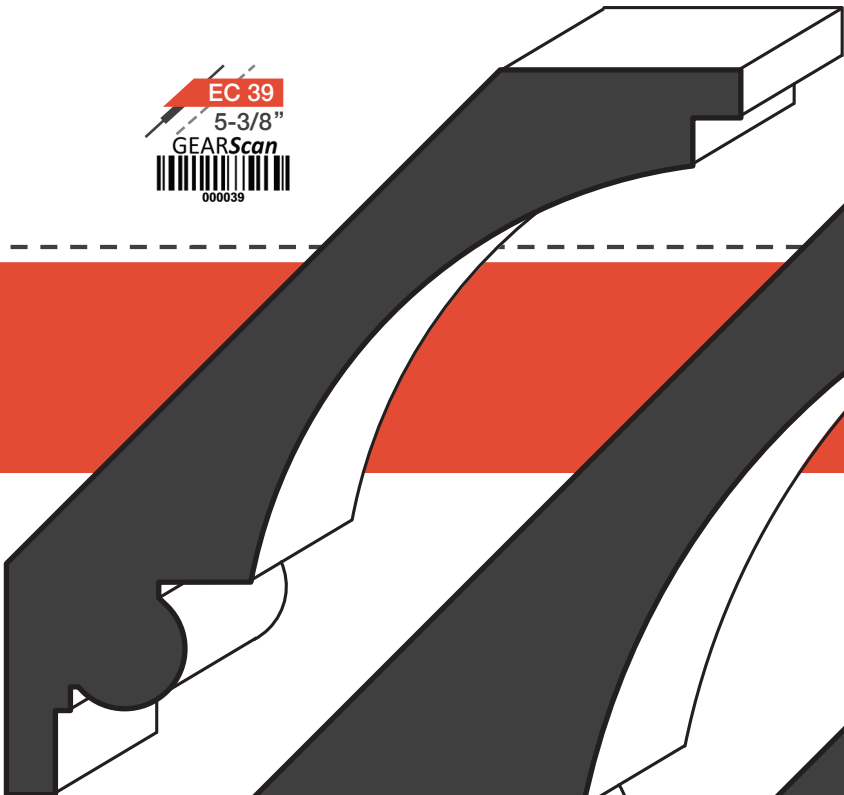

EC 50
5-1/4"
GEARScan
000050



EC 24
7-3/4"
GEARScan
000024



EC 33
6-1/4"
GEARScan
000033

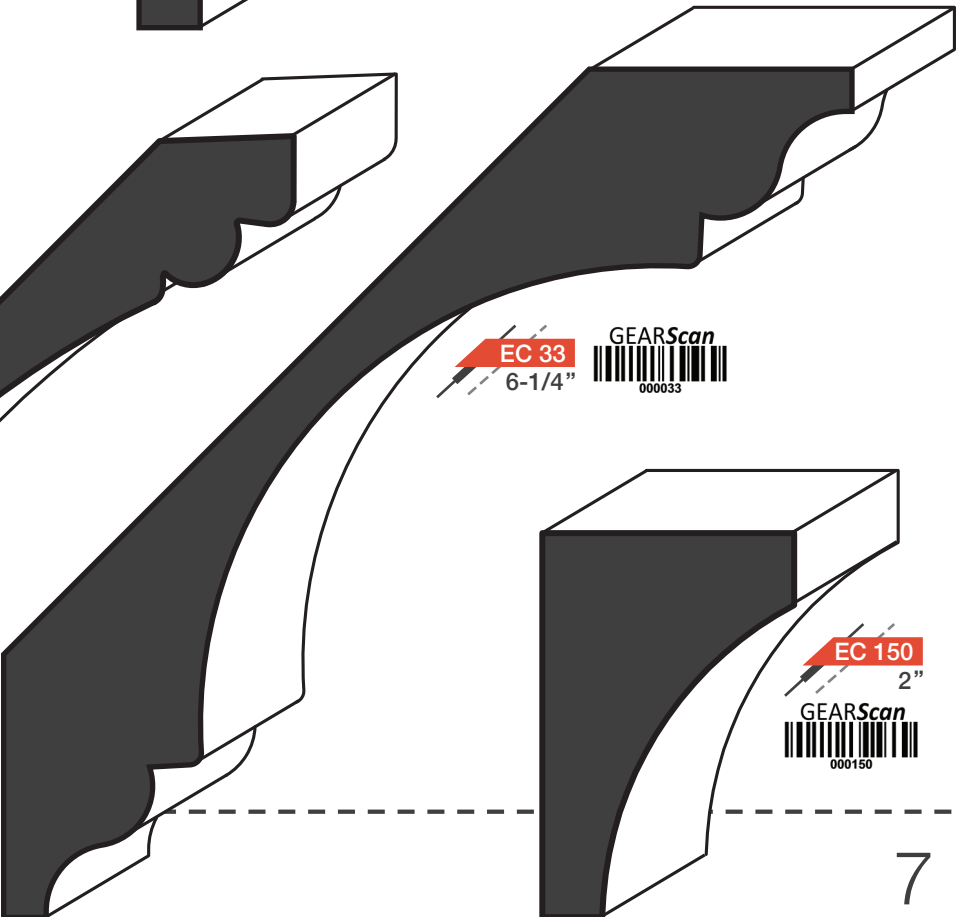

EC 501
5-1/2"
GEARScan
000501

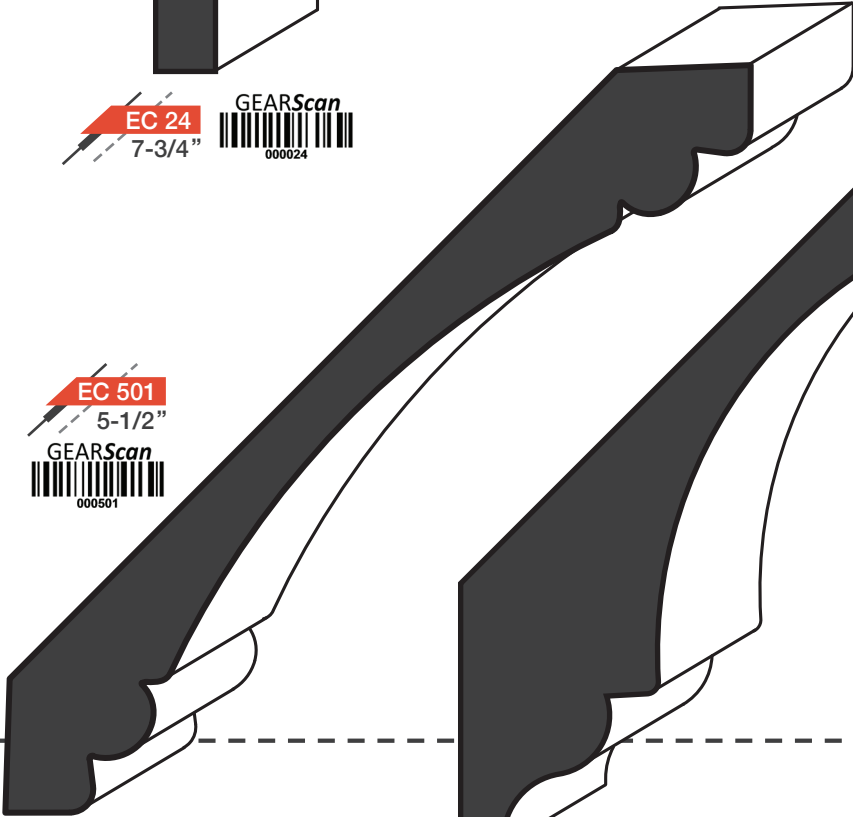

EC 150
2"
GEARScan
000150

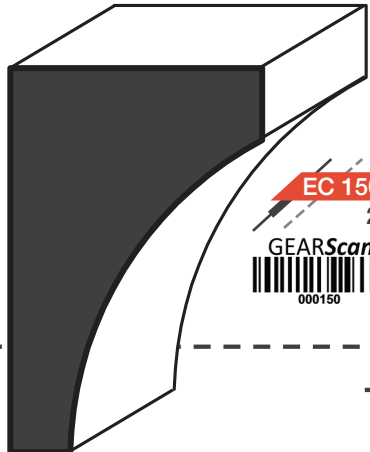

CROWN MOULDINGS

Including: Crown and Dentils

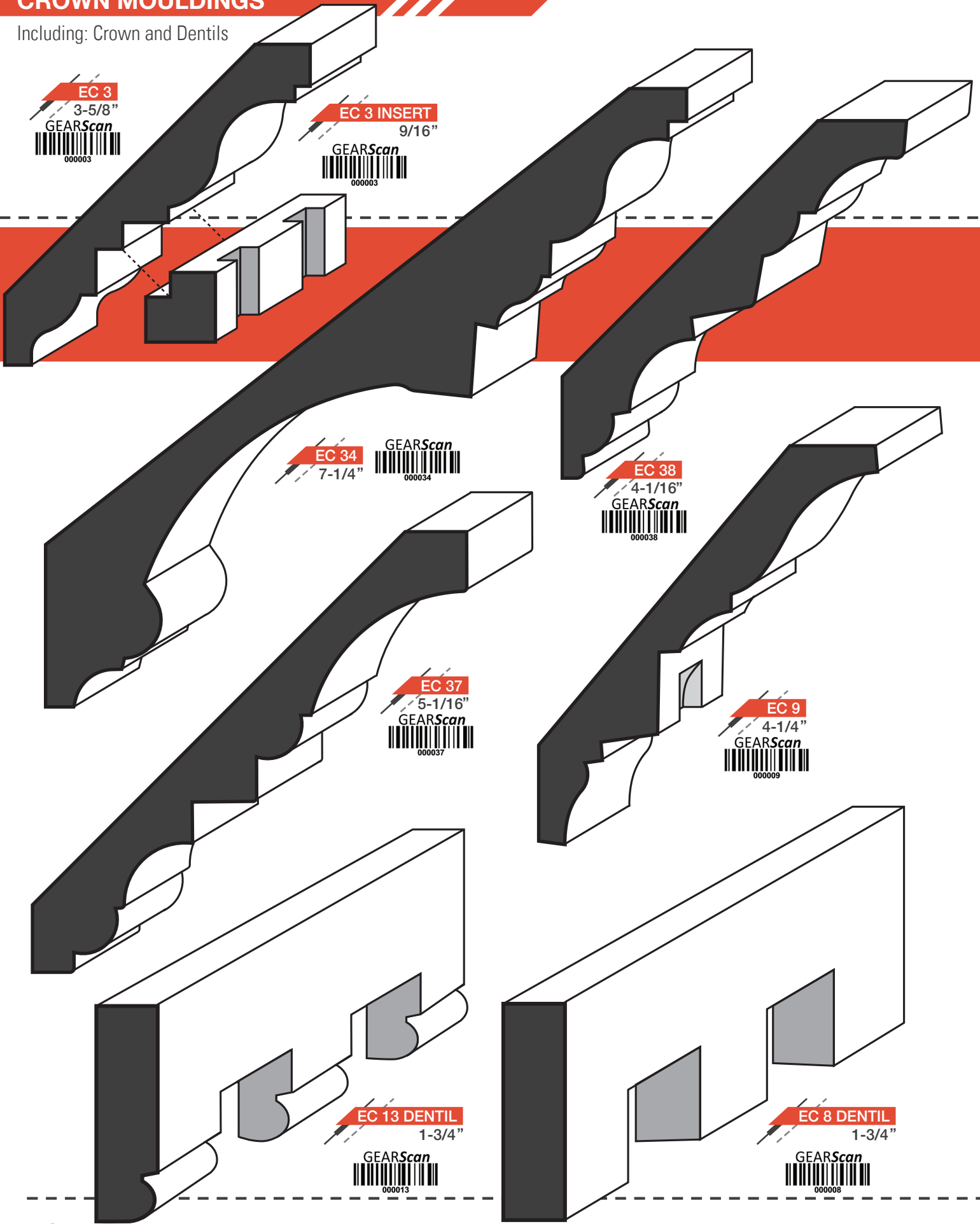

CROWN MOULDINGS

Including: Crown and Dentils

EC 18

4-1/4"

GEARScan



000018

EC 738

7-3/8"

GEARScan



000738

EC 818

8-1/8"

GEARScan



000818

EC 273

1-3/4"

GEARScan



000273

EC 61

6"

GEARScan



000061

EC 3609

1-3/4"

GEARScan



003609

CROWN MOULDINGS

Including: Crown and Dentils

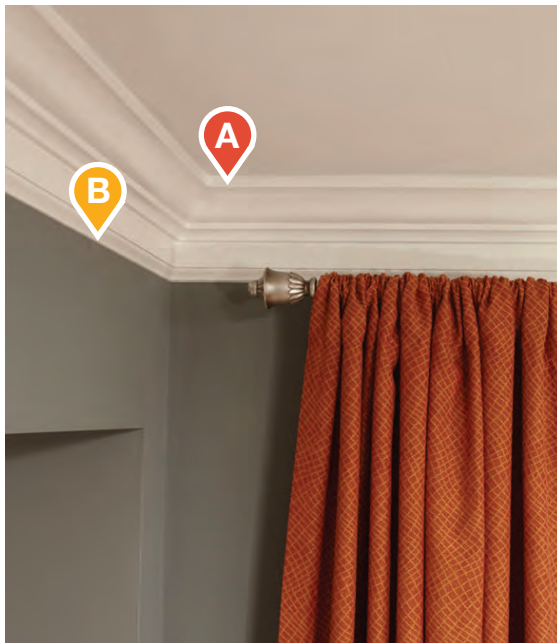

A EC 49 | Crown

B EC 623 | Base Inverted

CROWN MOULDINGS

Including: Crown and Dentils

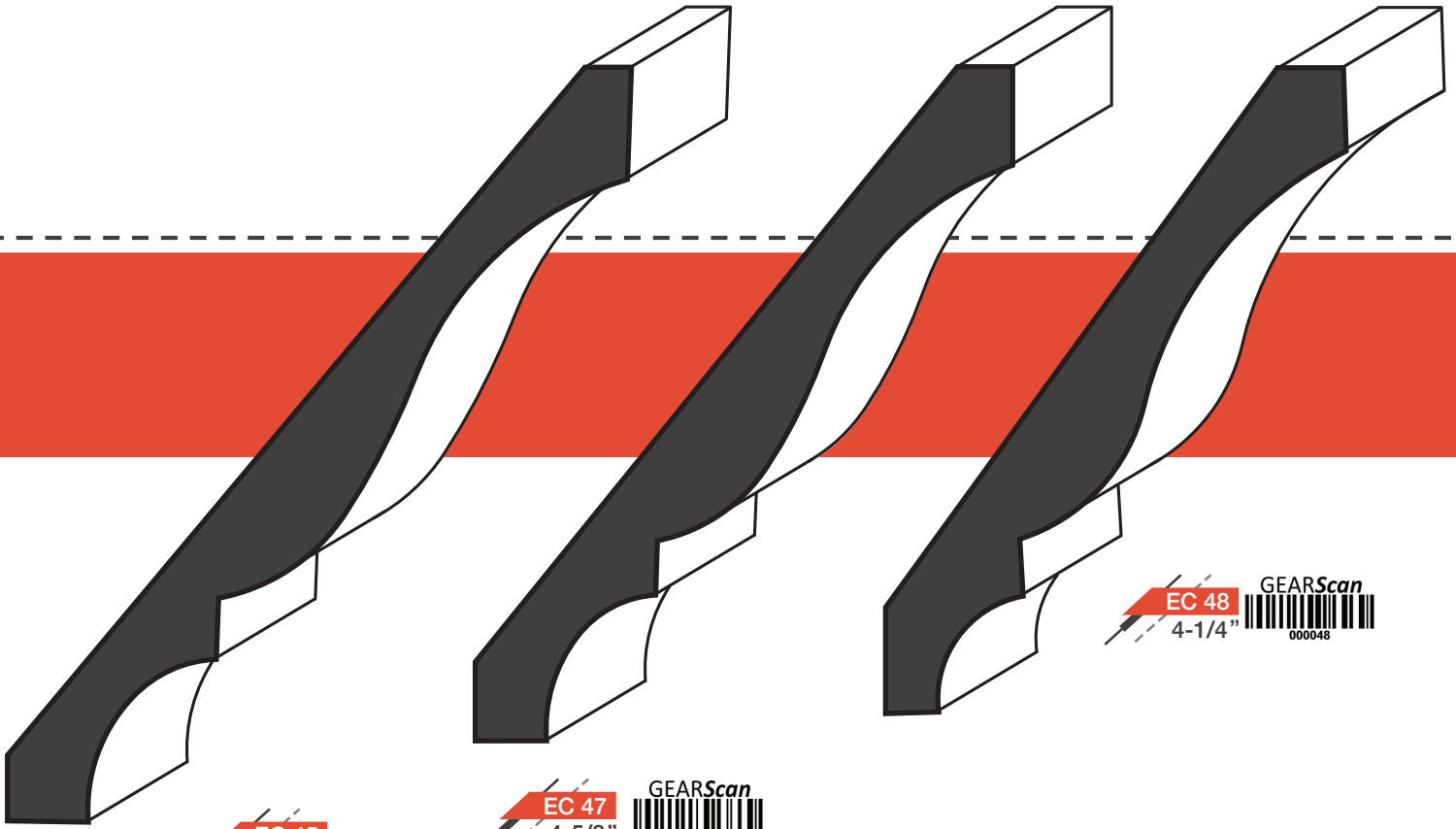

EC 45
5-1/4"
GEARScan
000045

EC 47
4-5/8"
GEARScan
000047

EC 48
4-1/4"
GEARScan
000048

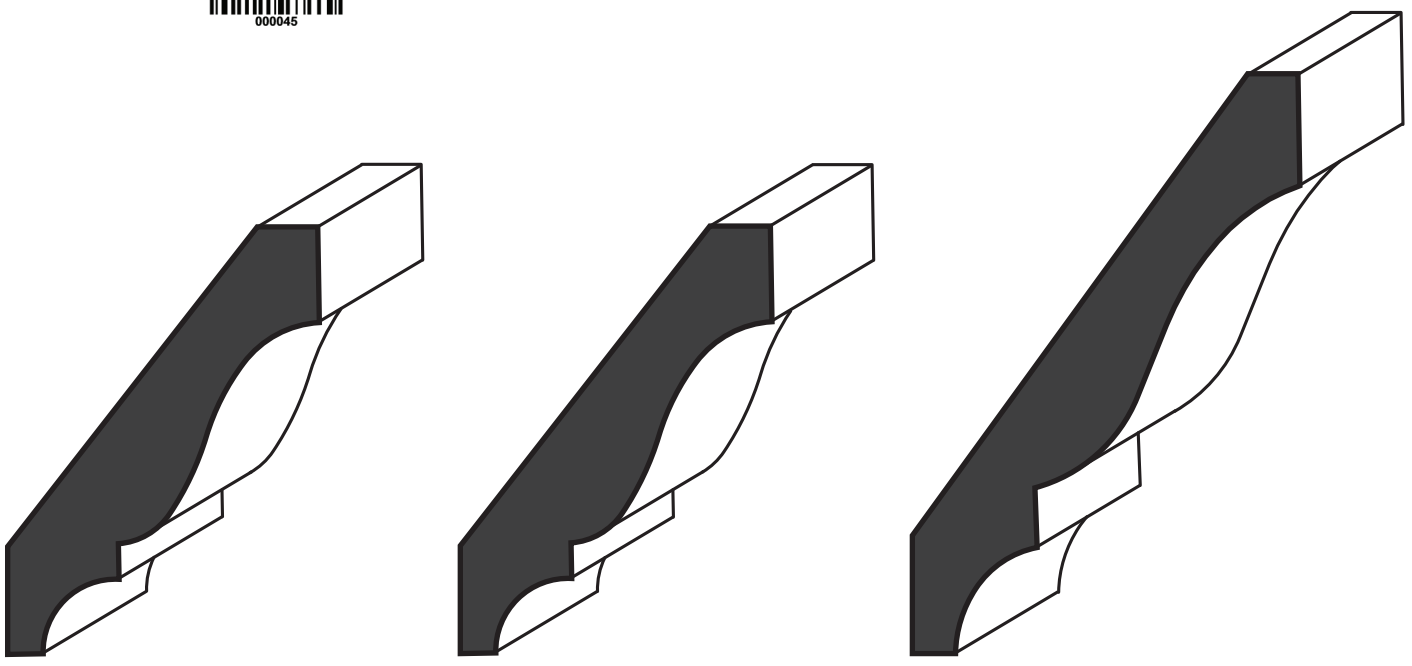

EC 52
2-3/4"
GEARScan
000052

EC 51
3-1/4"
GEARScan
000051

EC 49
3-5/8"
GEARScan
000049

CROWN MOULDINGS

Including: Crown and Dentils



EC 154
2"
GEARScan
000154

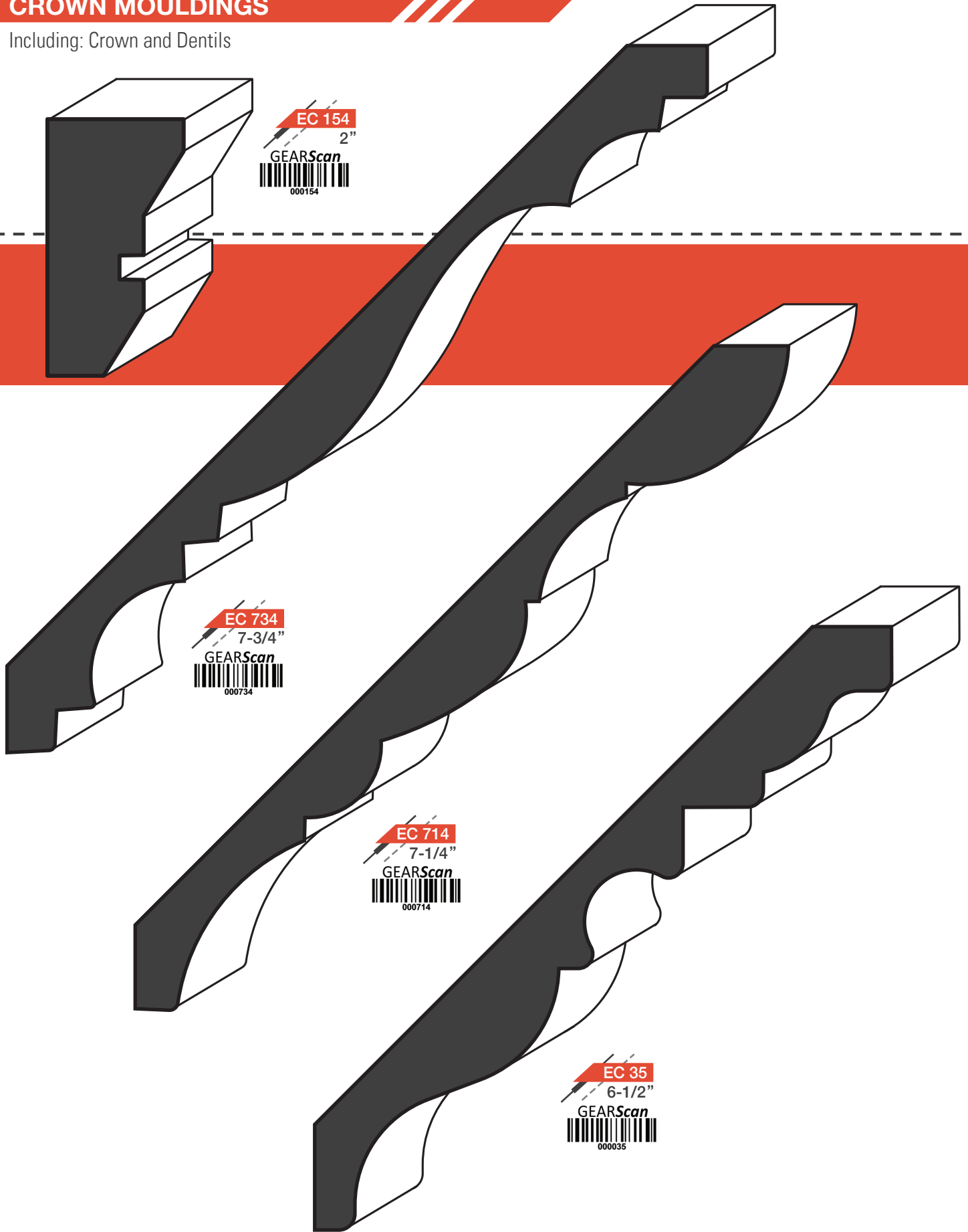

EC 734
7-3/4"
GEARScan
000734

EC 714
7-1/4"
GEARScan
000714

EC 35
6-1/2"
GEARScan
000035

DOOR AND WINDOW TRIM

Including: Back Bands, Rosettes, Plinths, Stops, Astragals, Stools, Aprons and Mullions

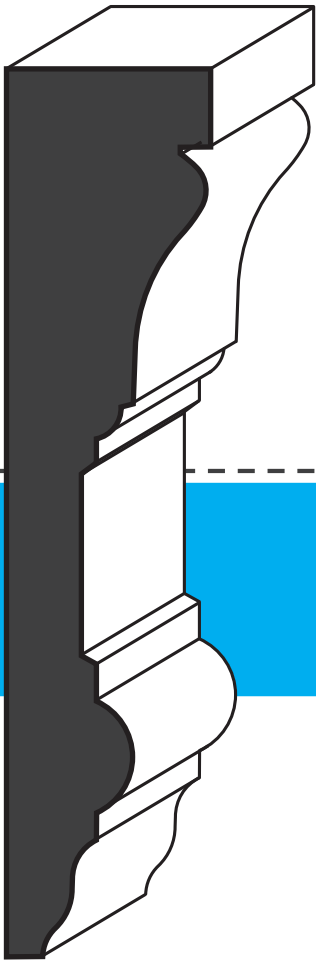

EC 466
4-5/8"
GEARScan
000466

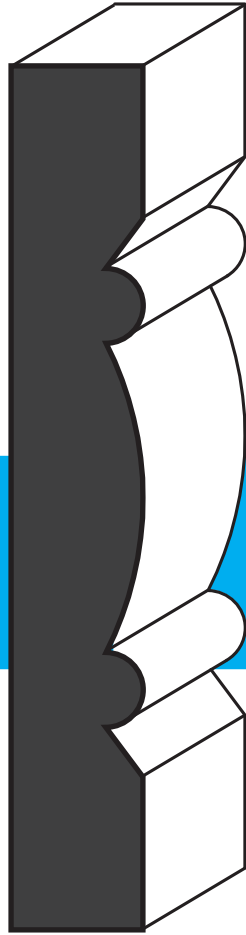

EC 412
4-1/2"
GEARScan
000412

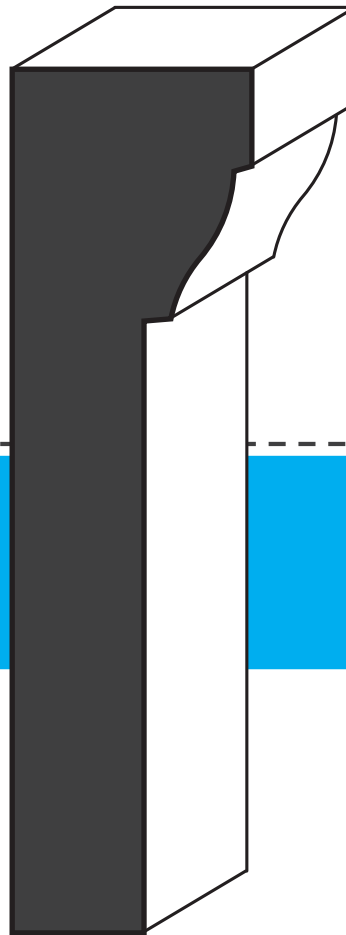

EC 190
4-1/2"
GEARScan
000190

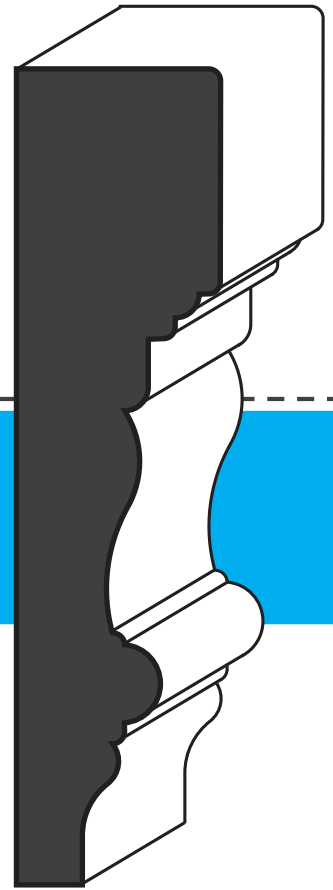

EC 414
4-1/4"
GEARScan
000414

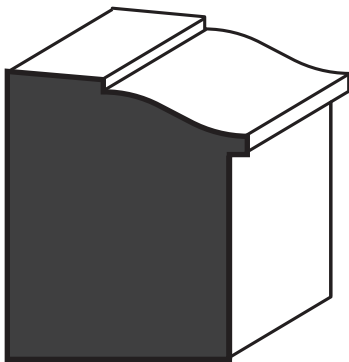

1-1/16"

EC 284
1-1/2"
GEARScan
000284

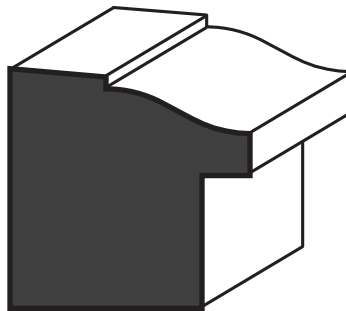

11/16"

EC 284A
1-1/4"
GEARScan
000285

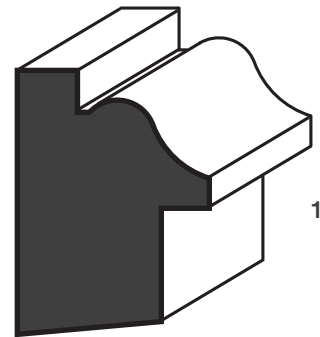

11/16"

EC 282
1-3/8"
GEARScan
000282

DOOR AND WINDOW TRIM

Including: Back Bands, Rosettes, Plinths, Stops, Astragals, Stools, Aprons and Mullions

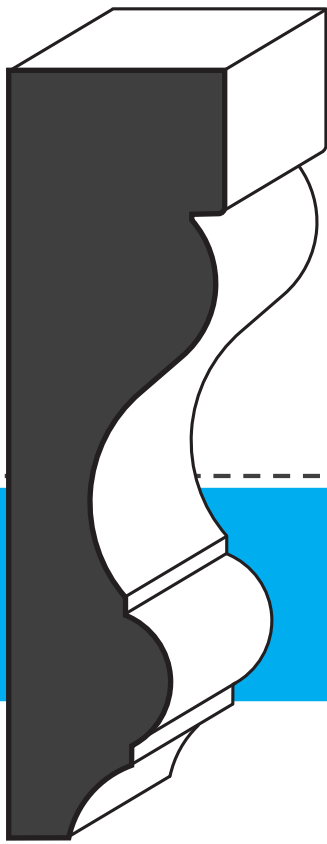

EC 436
4"
GEARScan
000436

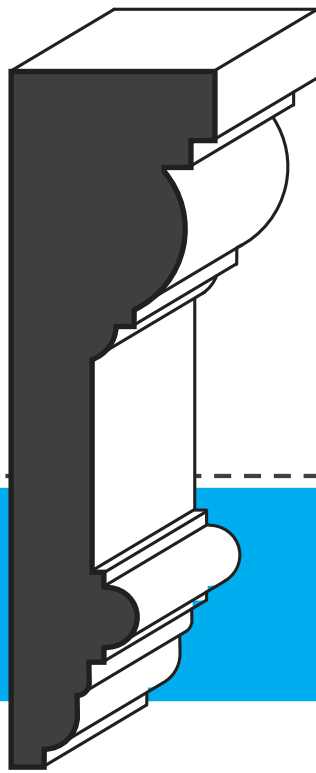

EC 446
3-5/8"
GEARScan
000446

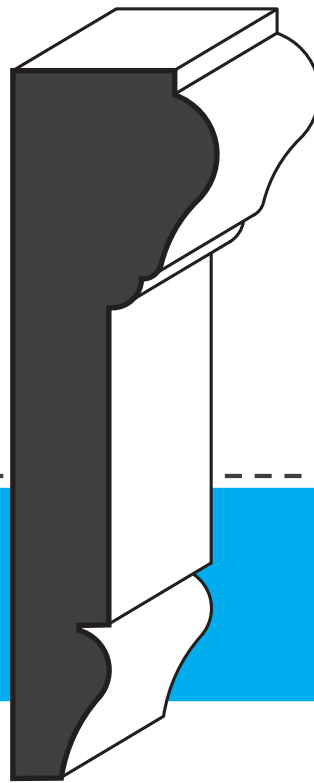

EC 460
3-11/16"
GEARScan
000460

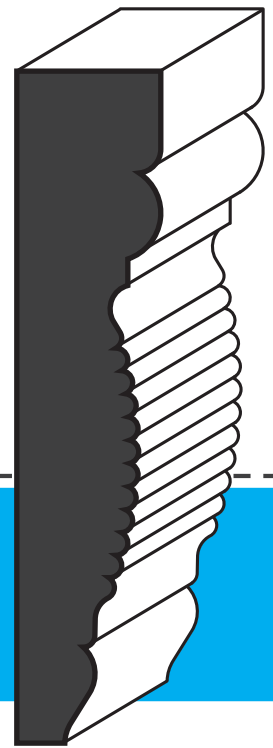

EC 453
3-1/2"
GEARScan
000453

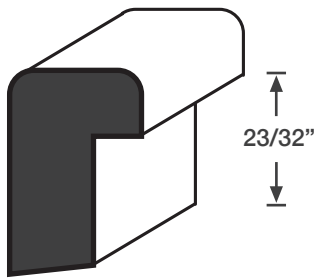

EC 280
1-1/16"
GEARScan
000280

23/32"

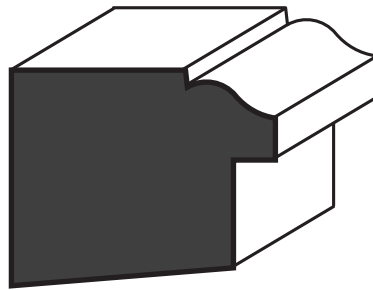

EC 283
1-3/8"
GEARScan
000283

11/16"

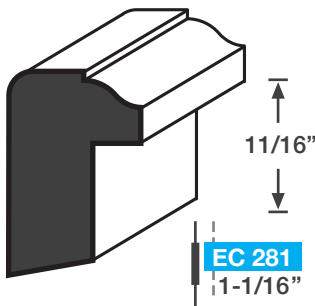

EC 281
1-1/16"
GEARScan
000281

11/16"

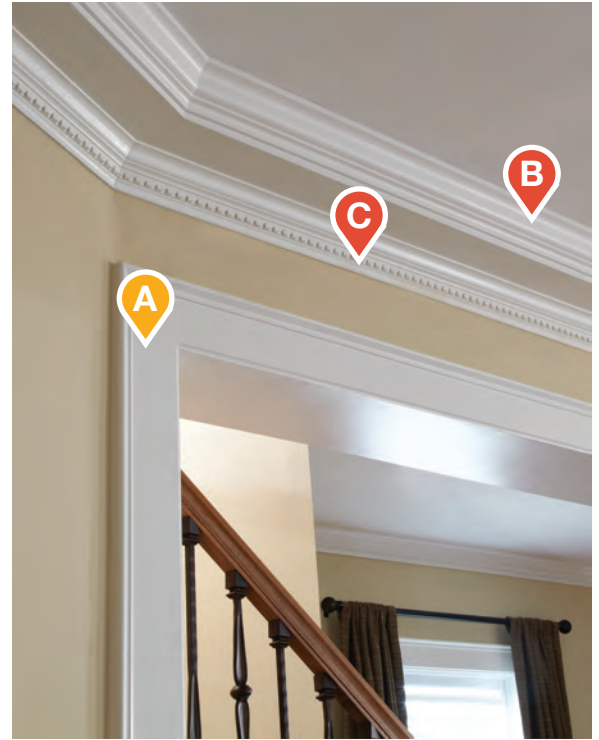

A 1 x 4 w/ EC 163 | Cap

B EC 45 | Crown

C EC 9 | Dentil

DOOR AND WINDOW TRIM

Including: Back Bands, Rosettes, Plinths, Stops, Astragals, Stools, Aprons and Mullions

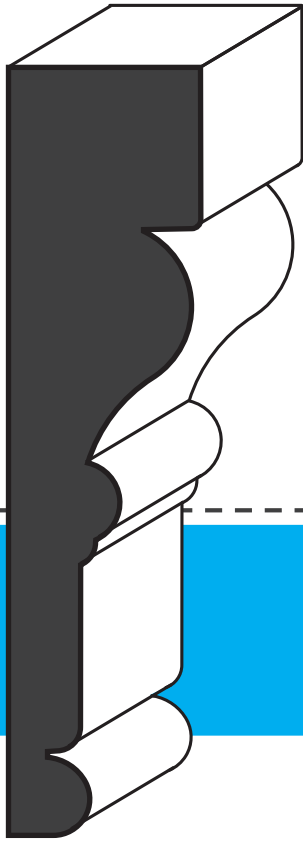

EC 4
4"
GEARScan
000004

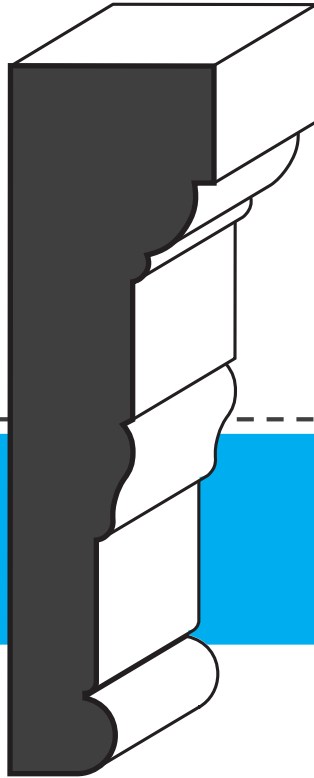

EC 470
3-11/16"
GEARScan
000470

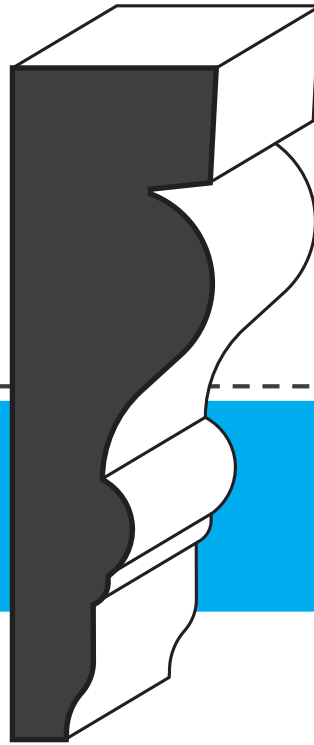

EC 464
3-1/2"
GEARScan
000464

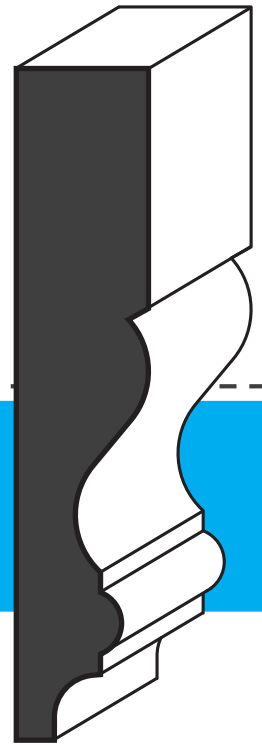

EC 350
3-1/2"
GEARScan
000350

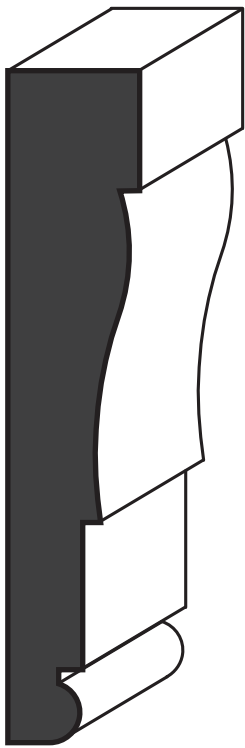

EC 445A
3-1/2"
GEARScan
000441



EC 445
3-1/4"
GEARScan
000445

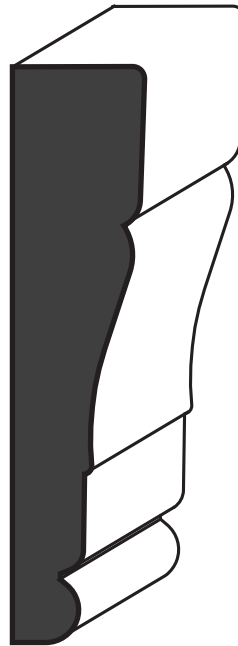

EC 371
3"
GEARScan
000371

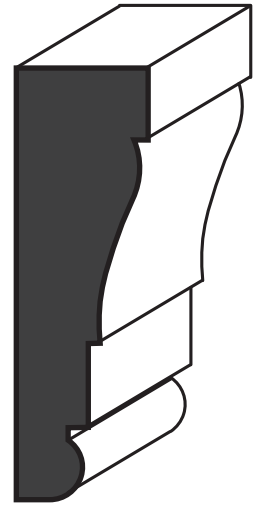

EC 376
2-1/4"
GEARScan
000376

DOOR AND WINDOW TRIM

Including: Back Bands, Rosettes, Plinths, Stops, Astragals, Stools, Aprons and Mullions

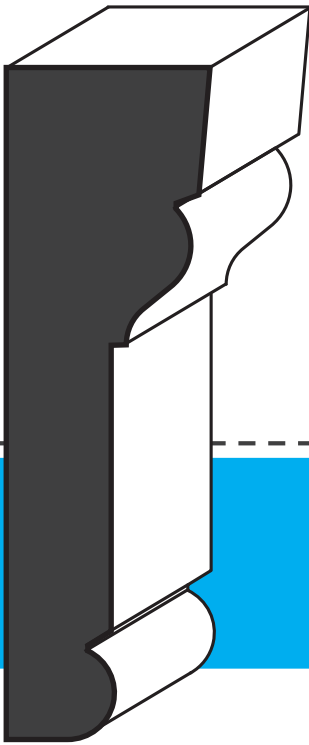

EC 20
3-1/2"
GEARScan
000020

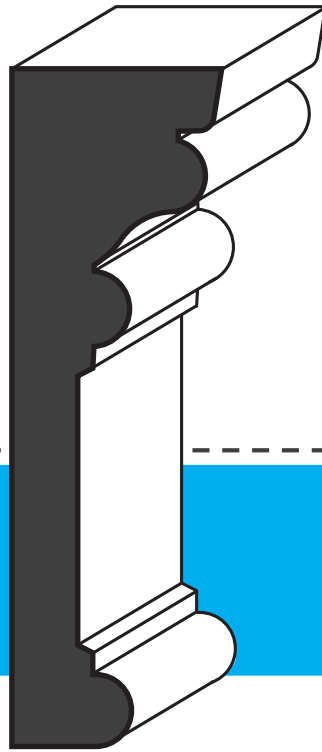

EC 1
3-1/2"
GEARScan
000400

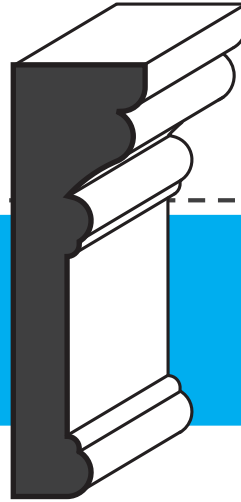

EC 401
2-1/4"
GEARScan
000401

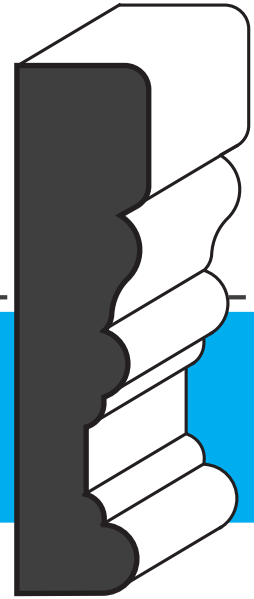

EC 402
2-3/4"
GEARScan
000402

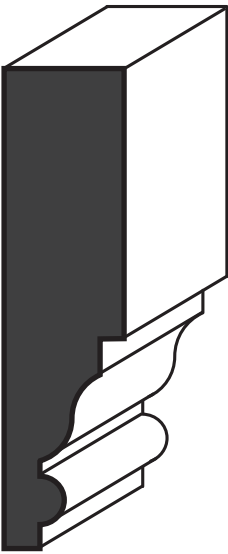

EC 12
2-1/2"
GEARScan
000012

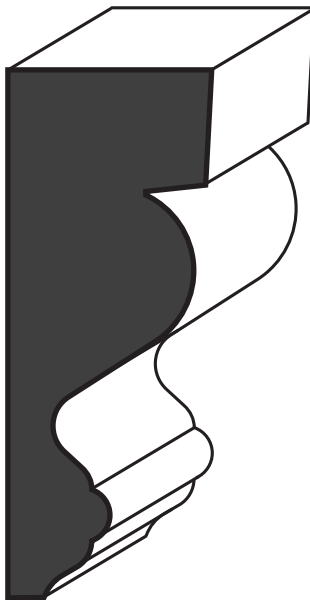

EC 463
2-3/4"
GEARScan
000463

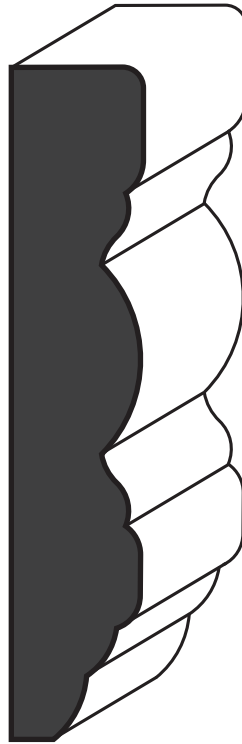

EC 455
3-1/2"
GEARScan
000455

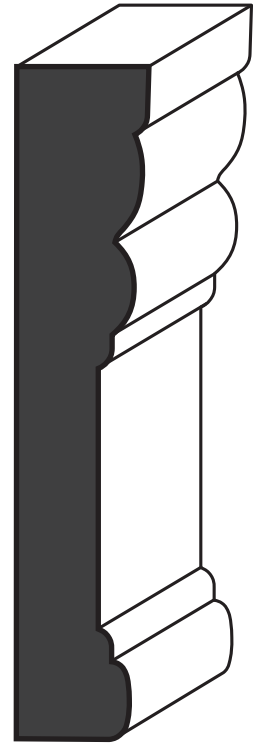

EC 480
3-1/2"
GEARScan
000480

DOOR AND WINDOW TRIM

Including: Back Bands, Rosettes, Plinths, Stops, Astragals, Stools, Aprons and Mullions

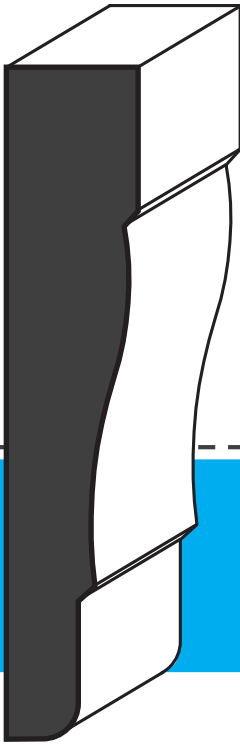

EC 444A GEARScan
3-1/2" 000443

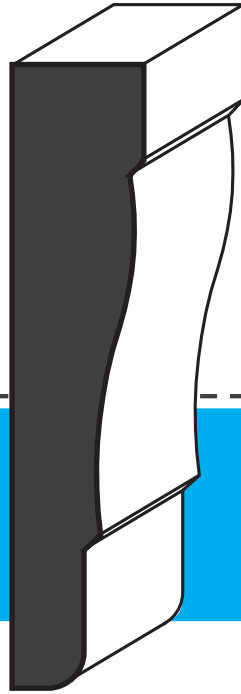

EC 444 GEARScan
3-1/4" 000444

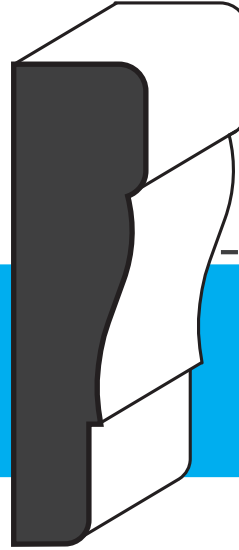

EC 351 GEARScan
2-1/2" 000351

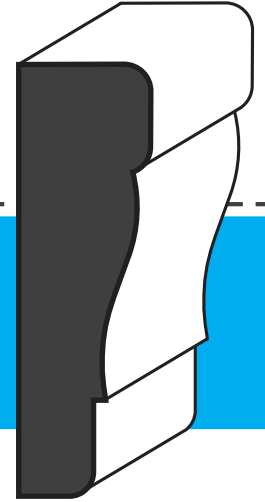

EC 356 GEARScan
2-1/4" 000356

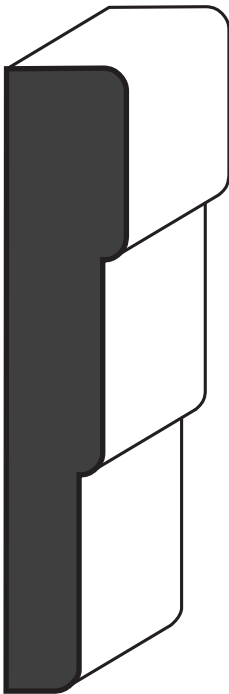

EC 683 GEARScan
3-1/4" 000683

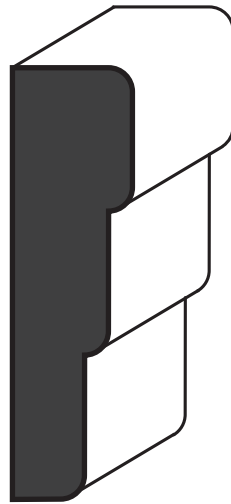

EC 387 GEARScan
2-1/4" 000387

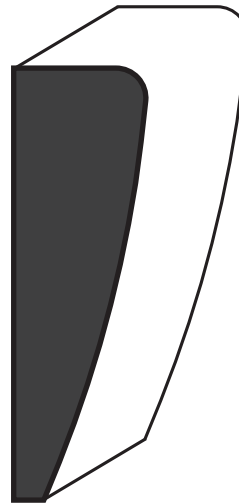

EC 327 GEARScan
2-1/4" 000327

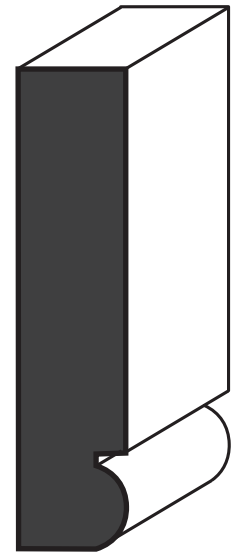

EC 755 GEARScan
2-1/2" 000755

DOOR AND WINDOW TRIM

Including: Back Bands, Rosettes, Plinths, Stops, Astragals, Stools, Aprons and Mullions



EC 465
3-1/2"



EC 361
3-1/4"

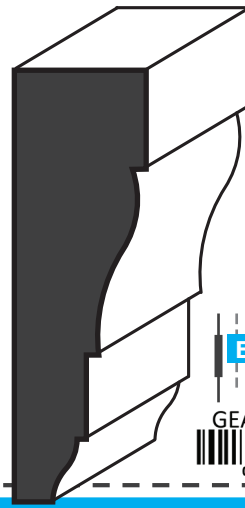

EC 366
2-1/4"

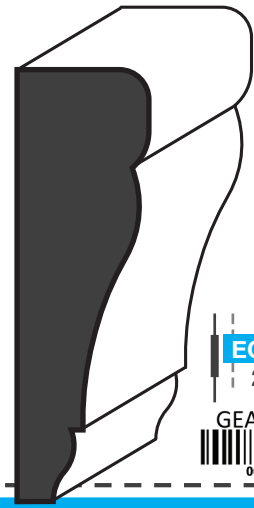

EC 442
2-1/4"

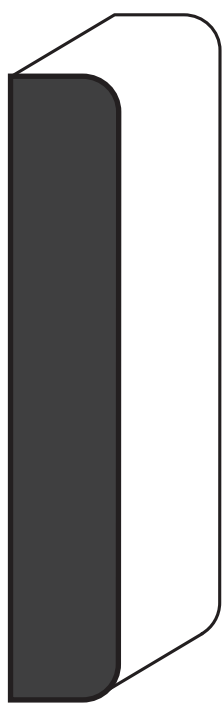

EC 433
3-1/4"

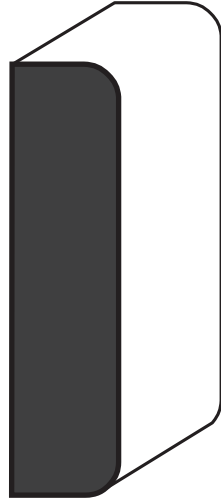

EC 473
2-1/4"

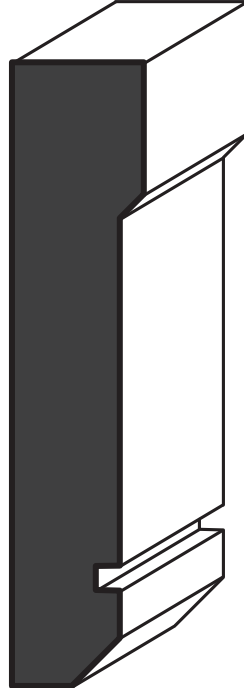

EC 405
3-1/4"

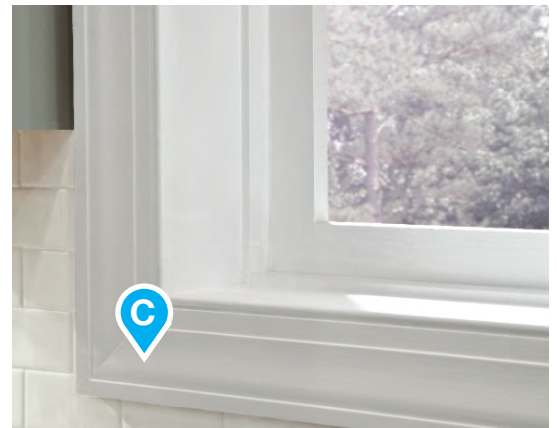

- A** EC 444 | Casing
- B** EC 988 | Mull
- C** EC 445 | Casing

Including: Back Bands, Rosettes, Plinths, Stops, Astragals, Stools, Aprons and Mullions

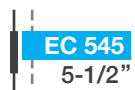
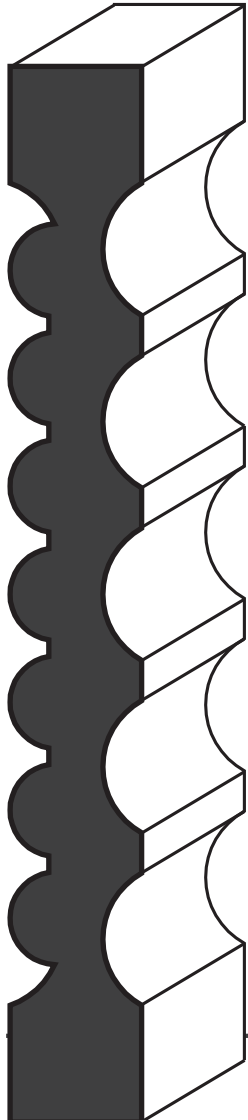
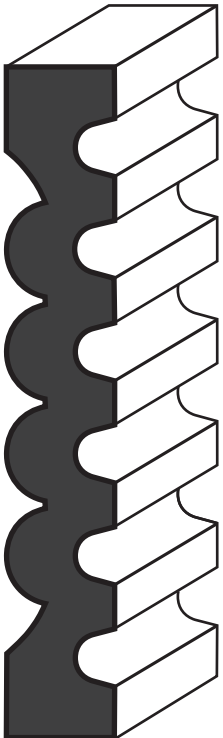
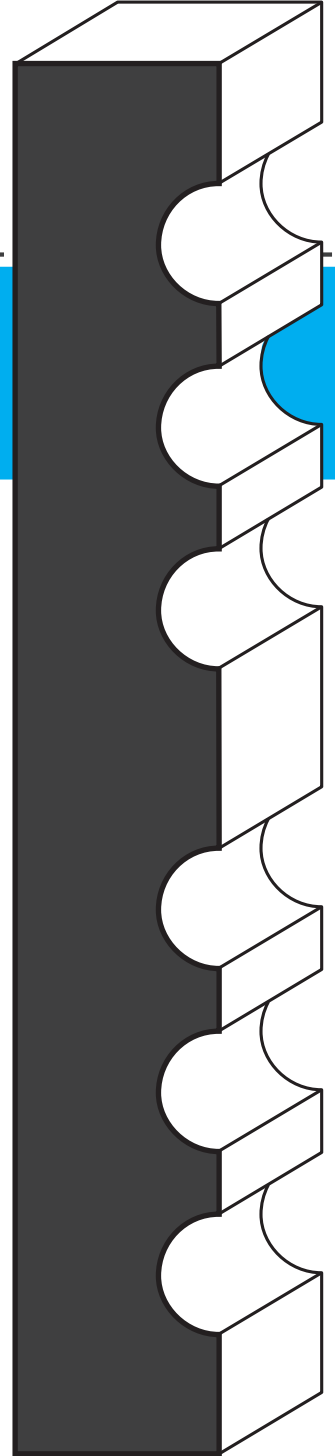
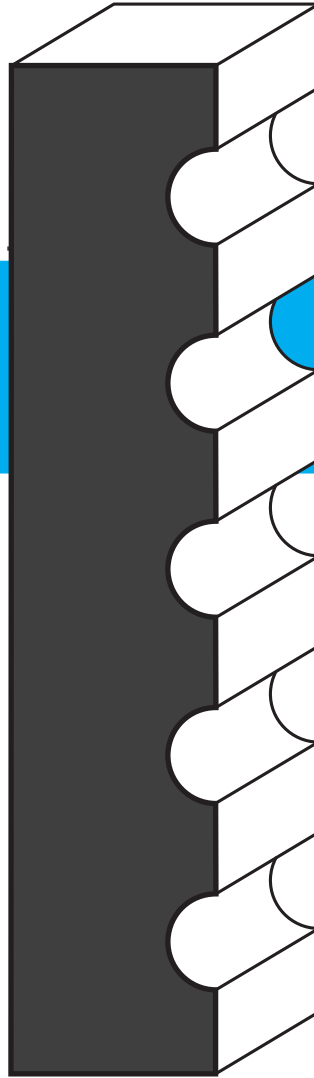
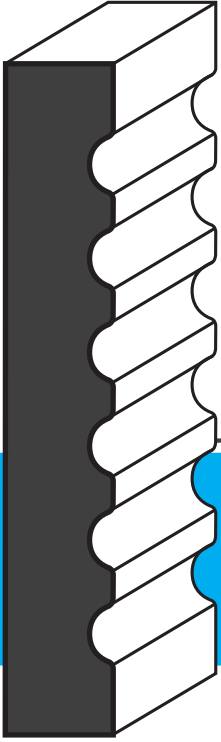

DOOR AND WINDOW TRIM

Including: Back Bands, Rosettes, Plinths, Stops, Astragals, Stools, Aprons and Mullions

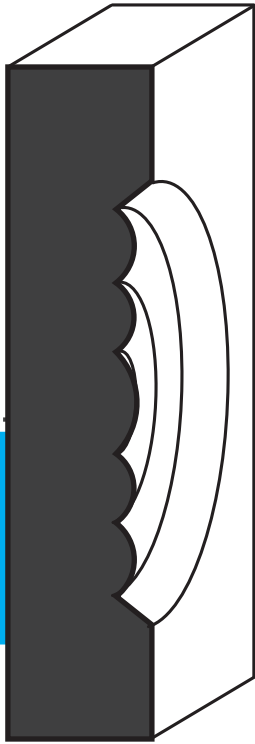

EC 30
3-1/2"
Rosette
GEARScan
000030

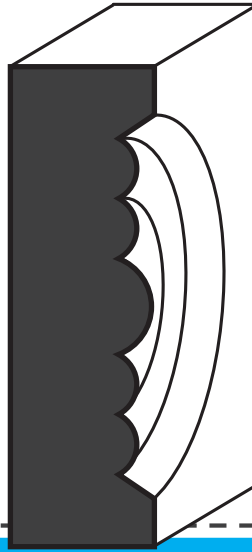

EC 29
2-1/2"
Rosette
GEARScan
000029

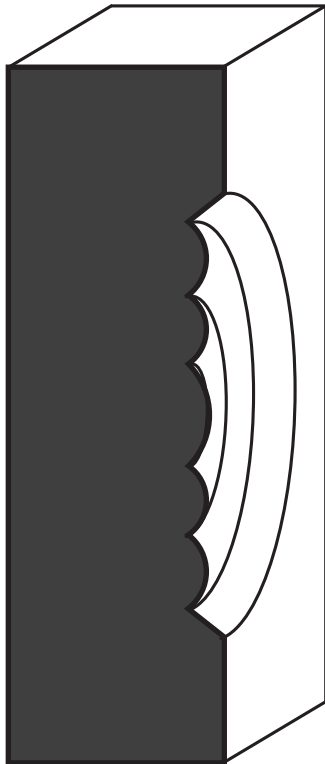

EC 28
3-5/8"
Rosette
GEARScan
000028

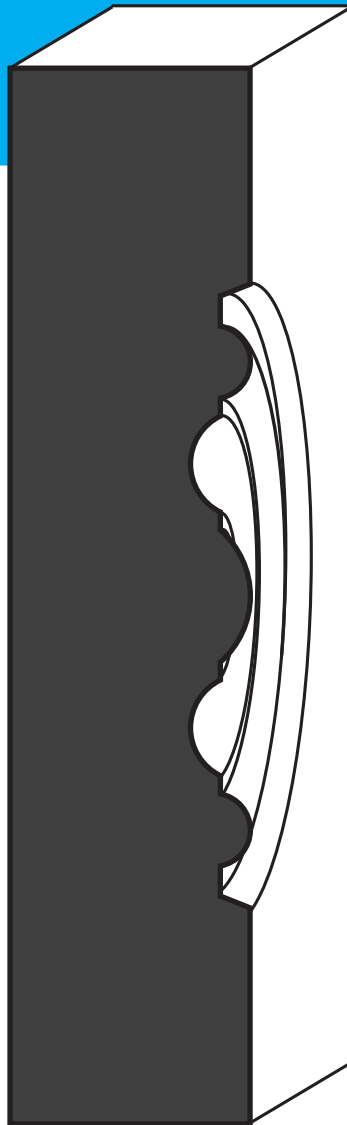

EC 25
5-1/2"
Rosette
GEARScan
000025

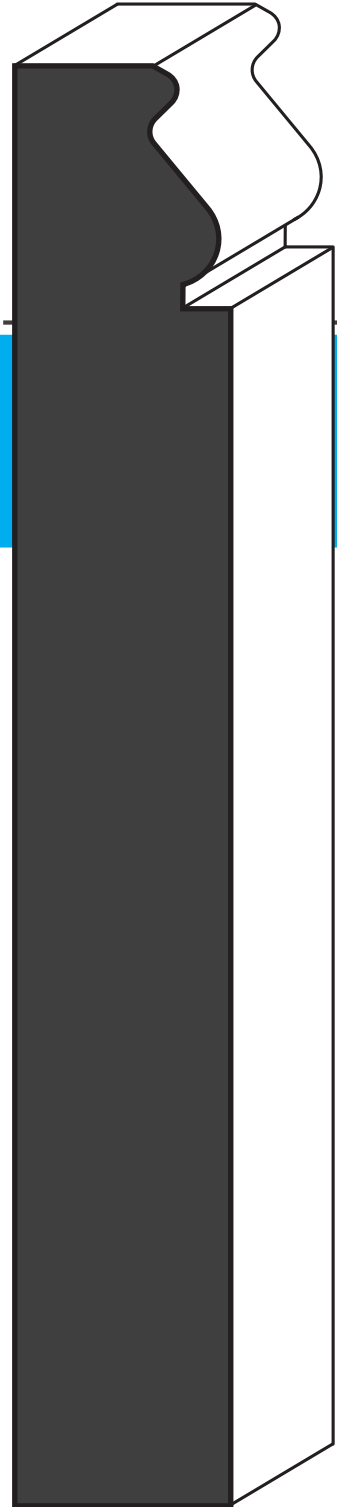

EC 26
3-1/2"
x 7-1/2"
Plinth
GEARScan
000026

DOOR AND WINDOW TRIM

Including: Back Bands, Rosettes, Plinths, Stops, Astragals, Stools, Aprons and Mullions

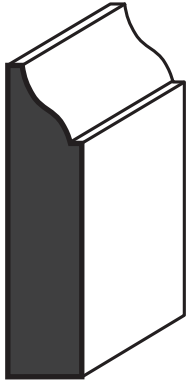

EC 935
1-5/8" GEARScan
000935



EC 936
1-3/8" GEARScan
000936



EC 937
1-1/4" GEARScan
000937

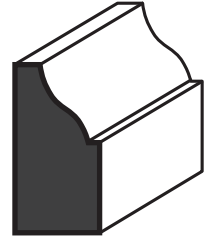

EC 940
7/8" GEARScan
000940



EC 941
5/8" GEARScan
000941



EC 941A
3/4" GEARScan
000942



EC 816
1-3/8" GEARScan
000816



EC 817
1-1/4" GEARScan
000817

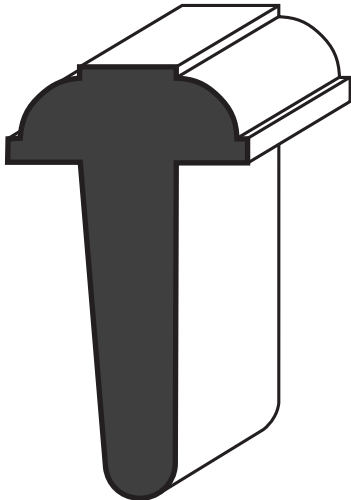

EC 1300
1-3/4" GEARScan
001300

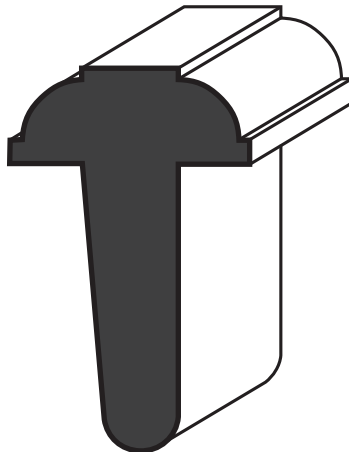

EC 1305
1-3/8" GEARScan
001305

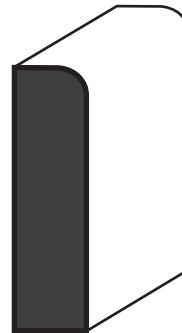

EC 886
1-3/8" GEARScan
000886

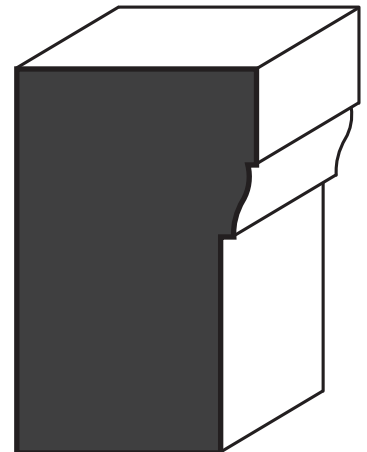

EC 180
2" GEARScan
000180

DOOR AND WINDOW TRIM

Including: Back Bands, Rosettes, Plinths, Stops, Astragals, Stools, Aprons and Mullions

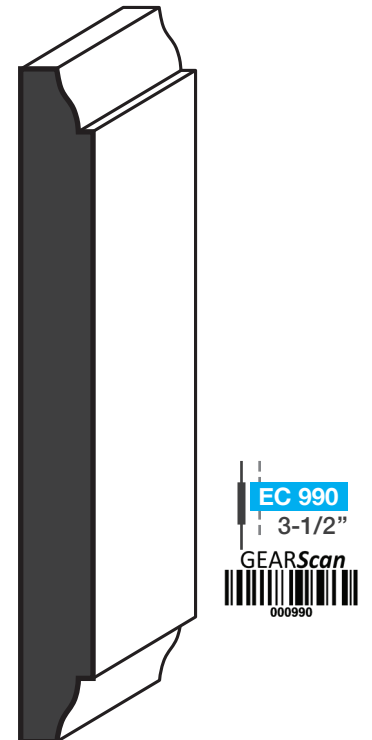
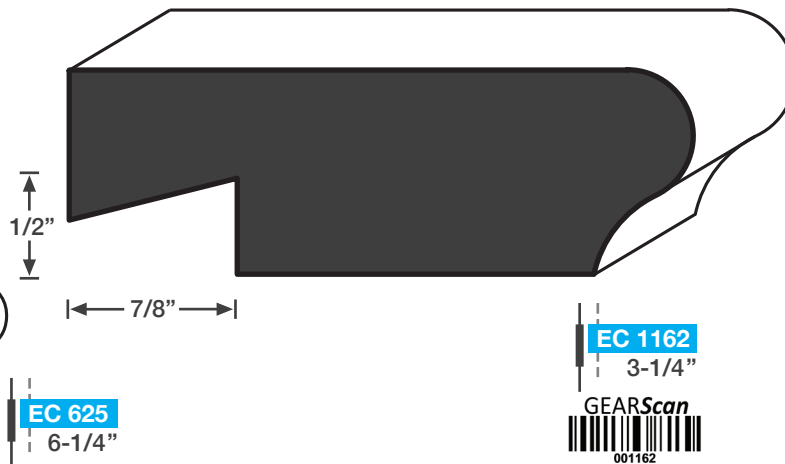
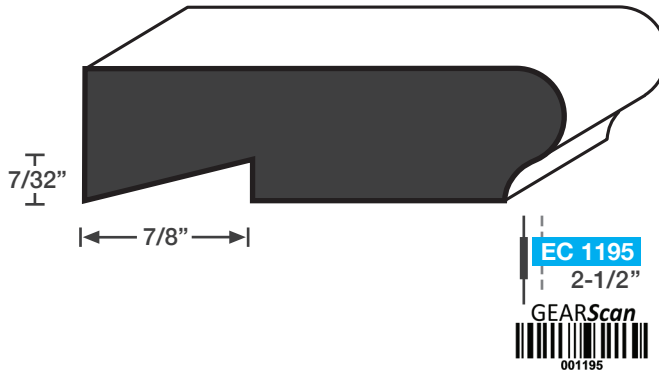
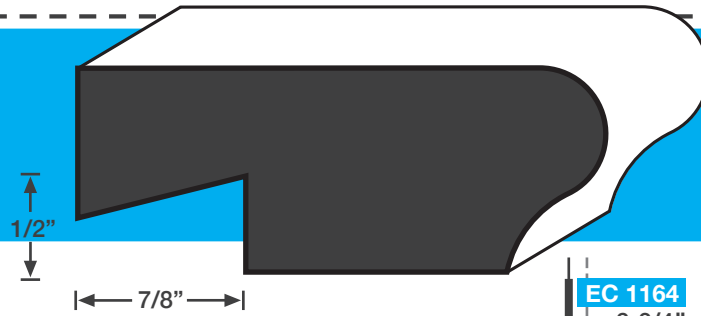
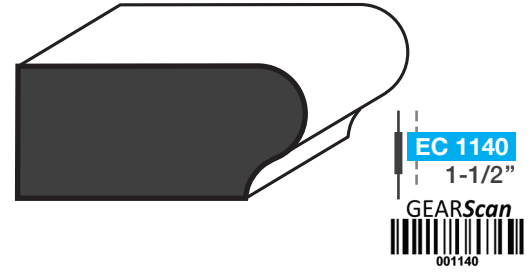
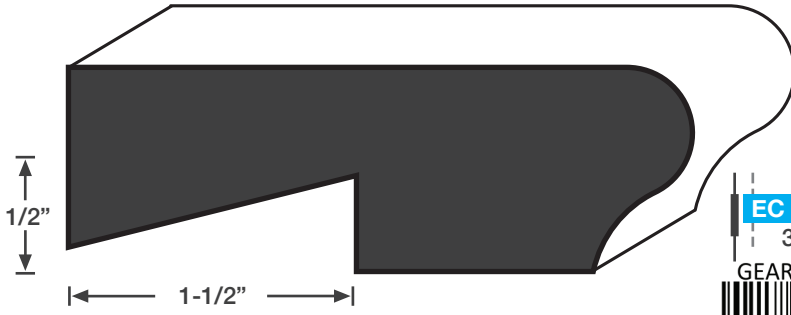

DOOR AND WINDOW TRIM

Including: Back Bands, Rosettes, Plinths, Stops, Astragals, Stools, Aprons and Mullions



EC 1021
4-1/2"

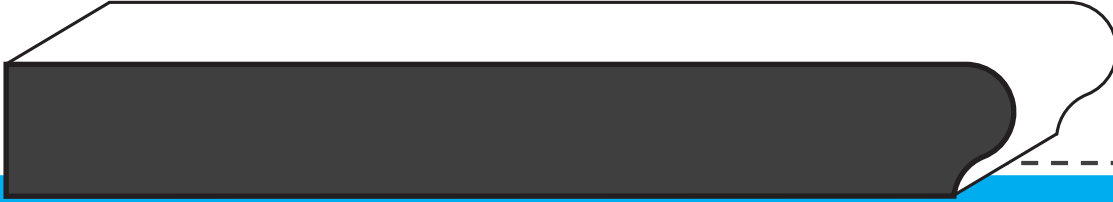

EC 1021
5-1/4"



EC 1021
7-1/4"



EC 1121
5-1/4"

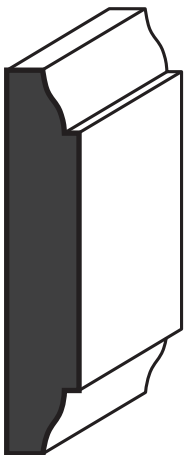

EC 987
2"

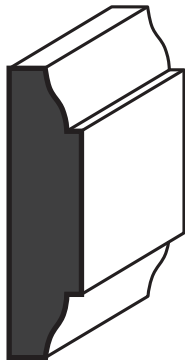

EC 988
1-1/2"

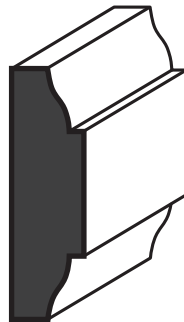

EC 988A
1-5/16"

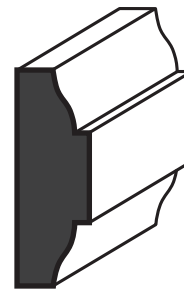

EC 989
1-1/8"

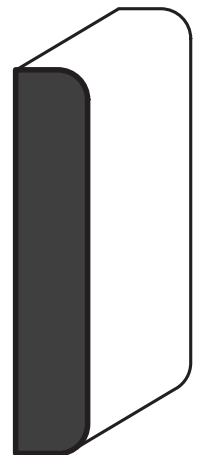

EC 987
2"



BASE MOULDINGS

Including: Base Caps and Shoe

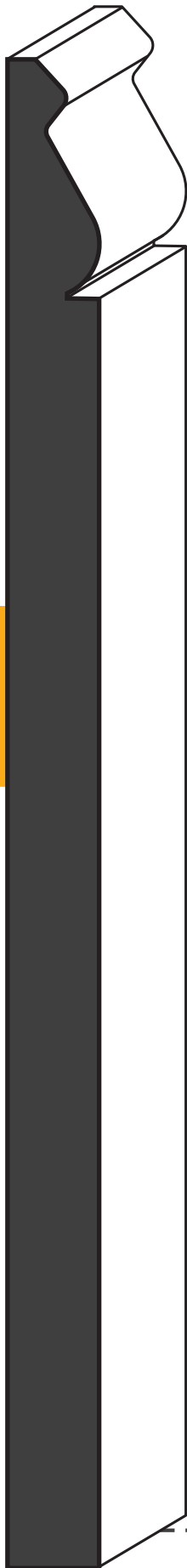

EC 910
9-1/4"  000910



EC 810
7-1/4"  000810



EC 616
6-1/8"  000616

EC 154
2"  000154

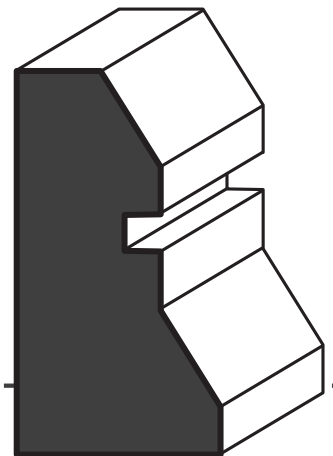

BASE MOULDINGS

Including: Base Caps and Shoe

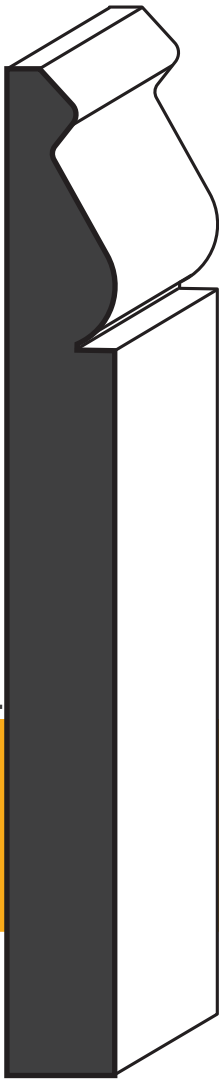

EC 610
5-1/4"
GEARScan
000610

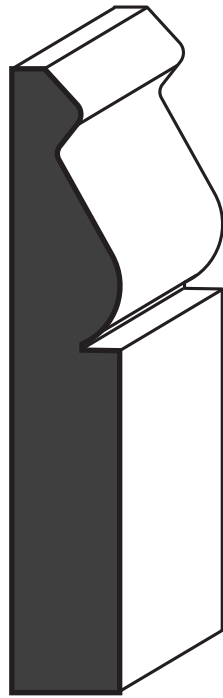

EC 310
3-1/4"
GEARScan
000310



EC 172
3/4"
GEARScan
000172

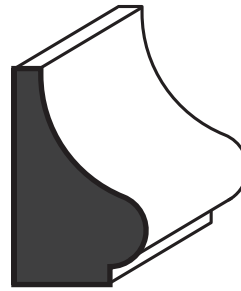

EC 167
1-1/8"
GEARScan
000167

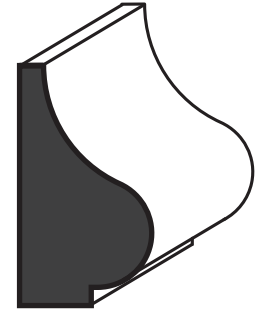

EC 166
1-1/4"
GEARScan
000166



EC 163
1-3/8"
GEARScan
000163



EC 162
1-1/8"
GEARScan
000162



EC 164
1-1/8"
GEARScan
000164



- A** EC 610 | Base
- B** EC 127 | Shoe

BASE MOULDINGS

Including: Base Caps and Shoe

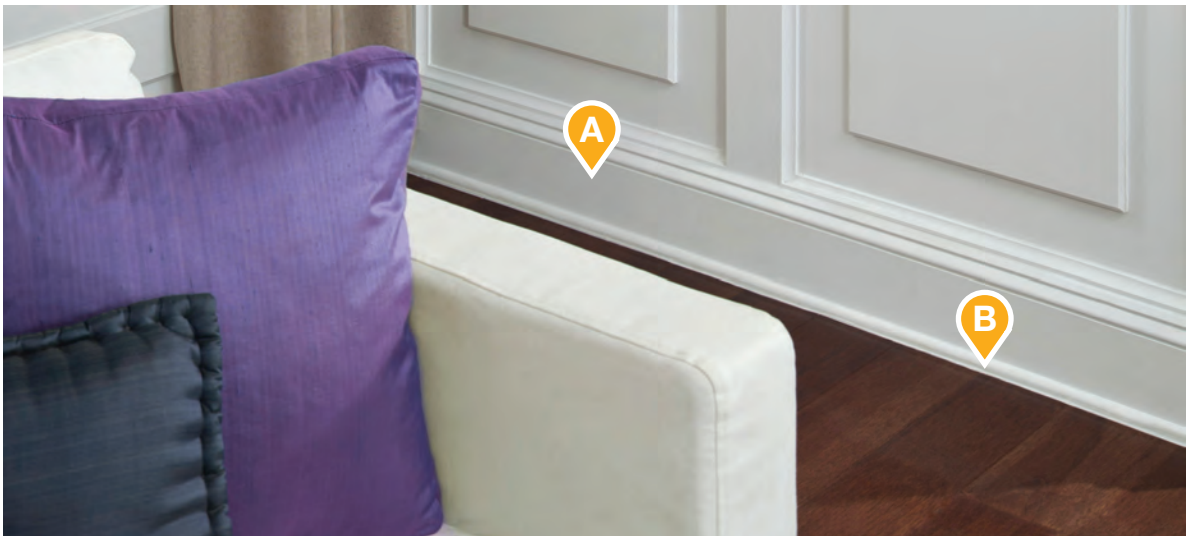
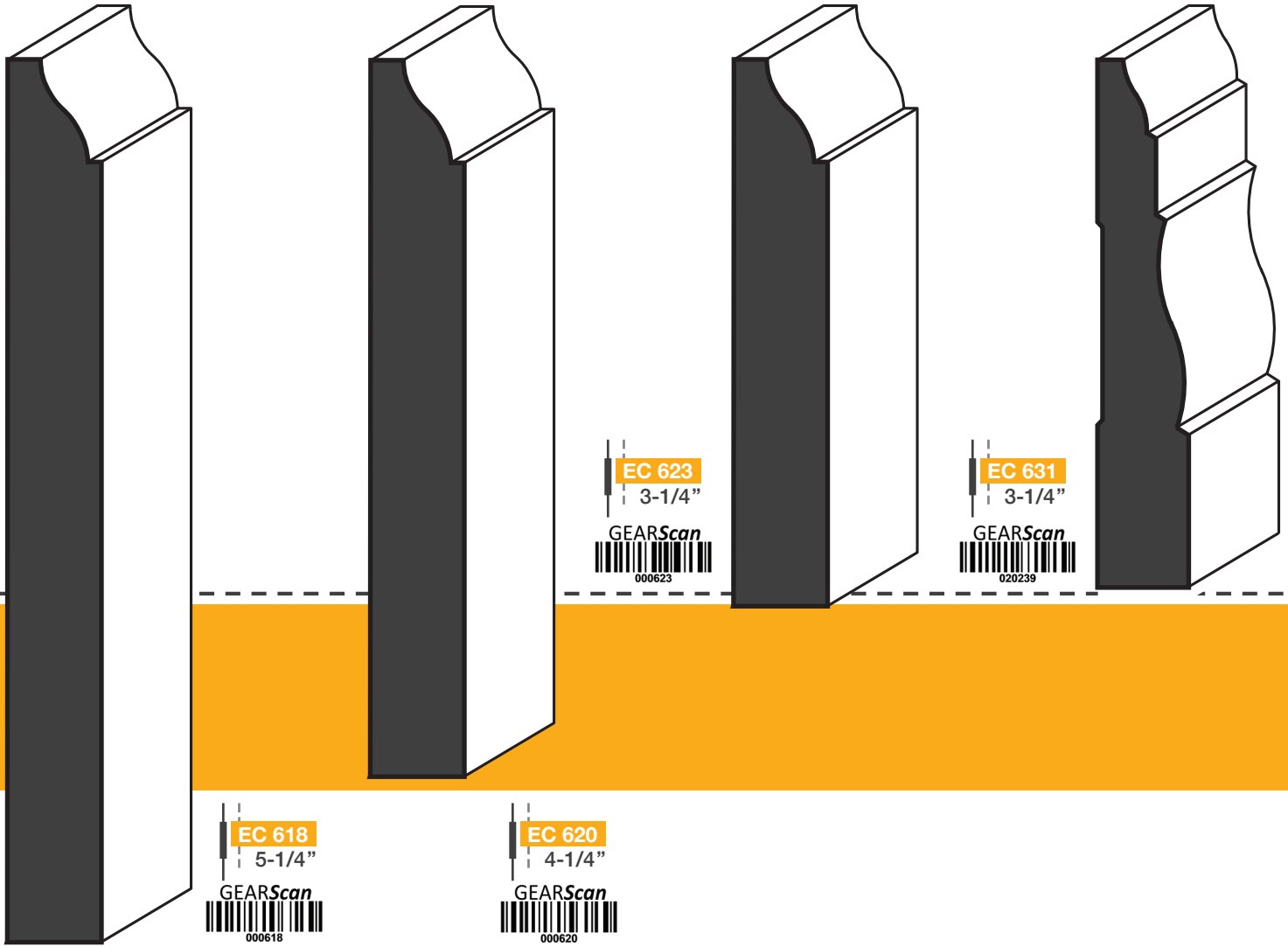

A EC 616 | Base **B** EC 127 | Shoe

BASE MOULDINGS

Including: Base Caps and Shoe

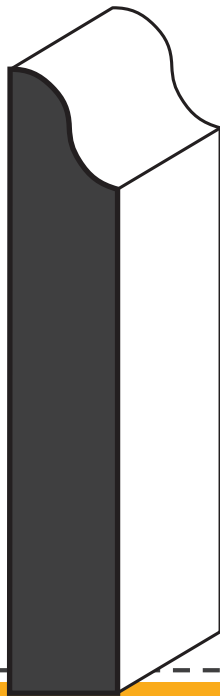

EC 663
3-1/4"
GEARScan
000663

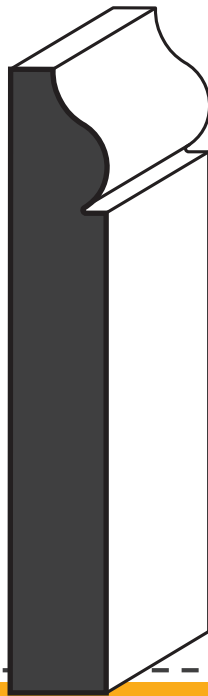

EC 623A
3-1/4"
GEARScan
000624

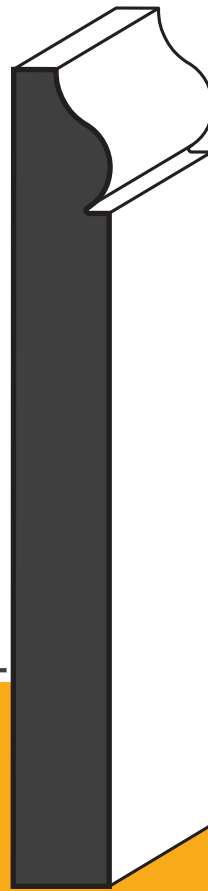

EC 620A
4-1/4"
GEARScan
000621

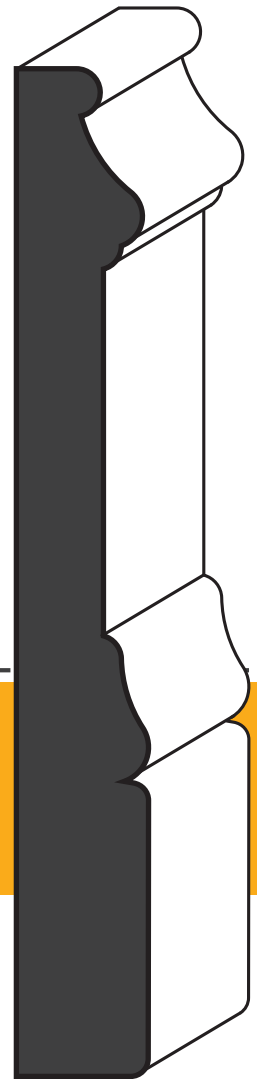

EC 467
5-1/4"
GEARScan
000467

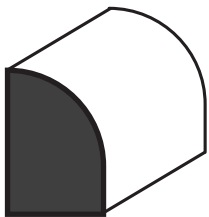

EC 126
3/4"
GEARScan
000126

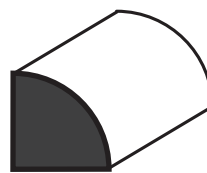

EC 108
1/2"
GEARScan
000108



EC 127
11/16"
GEARScan
000127

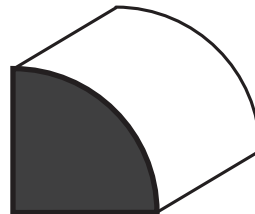

EC 105
3/4"
GEARScan
000105

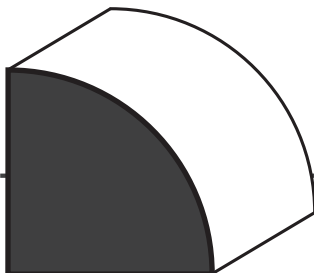

EC 103
1-1/16"
GEARScan
000103

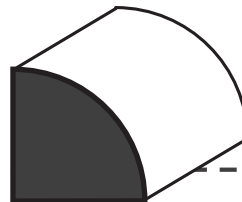

EC 106
11/16"
GEARScan
000106

BASE MOULDINGS

Including: Base Caps and Shoe

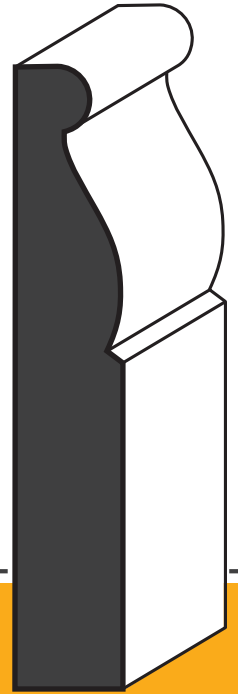
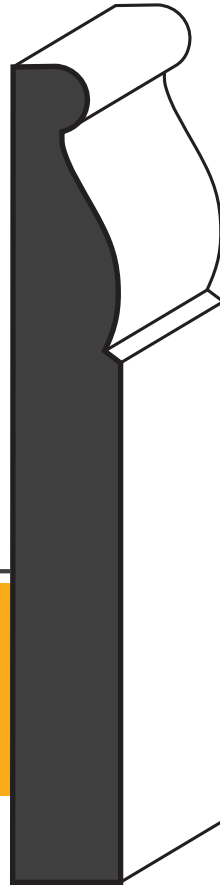
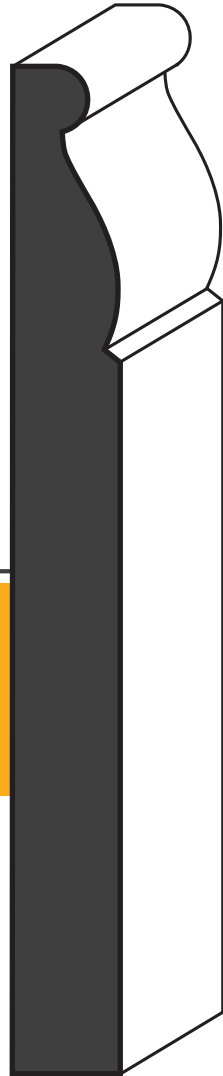
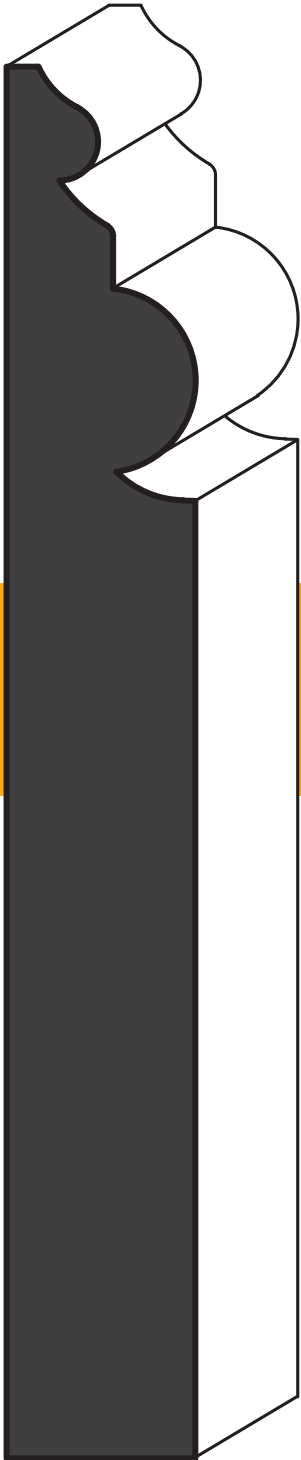

A EC 24 | Crown **B** EC 436 | Casing

BASE MOULDINGS

Including: Base Caps and Shoe

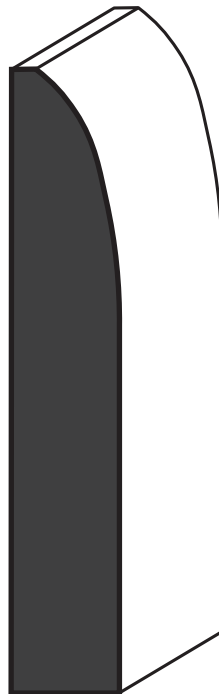
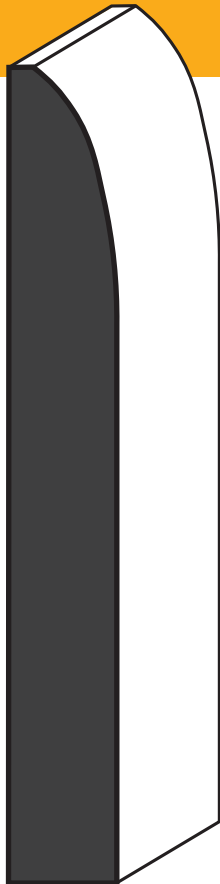
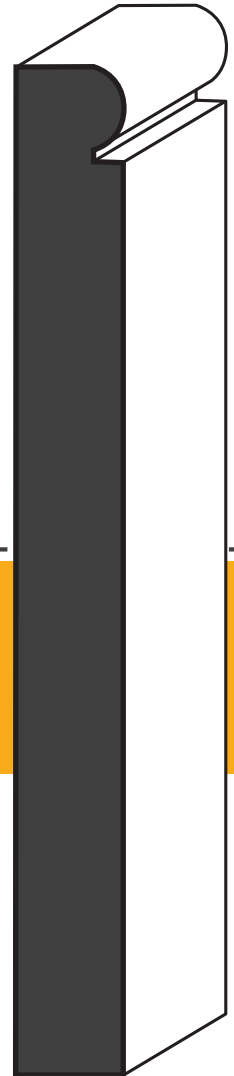
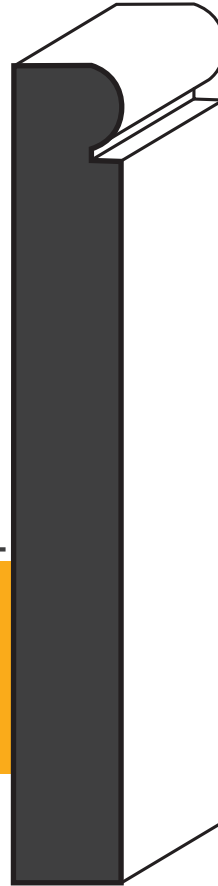
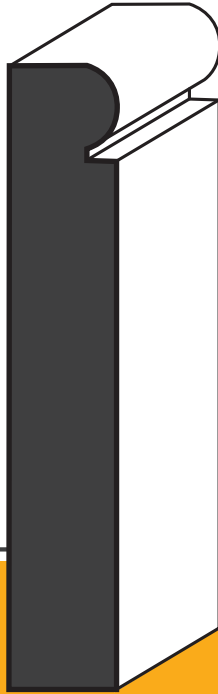
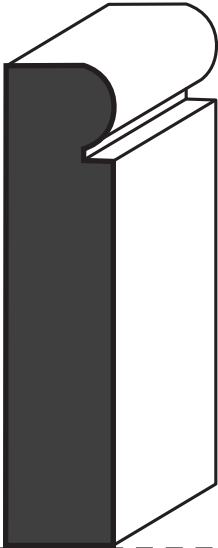

BASE MOULDINGS

Including: Base Caps and Shoe

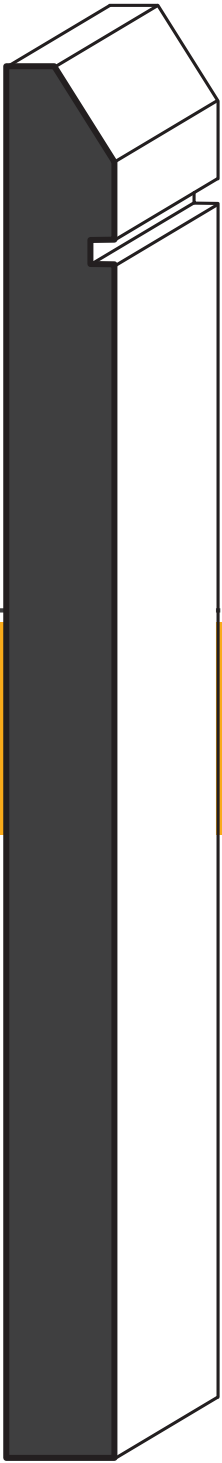

EC 700
7-1/4"

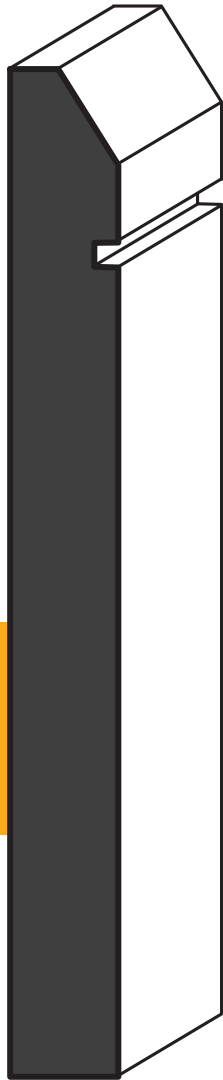

EC 705
5-1/4"

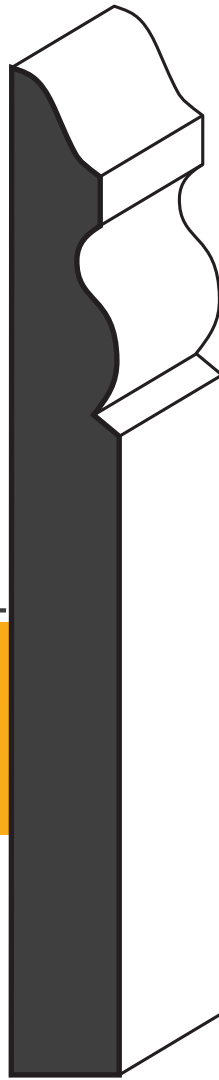

EC 5180
5-1/4"

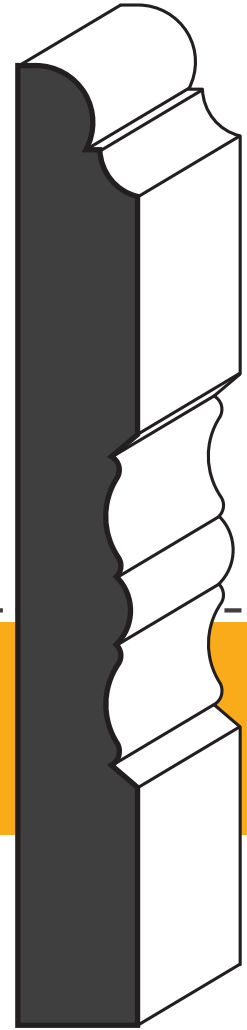

EC 19
5"

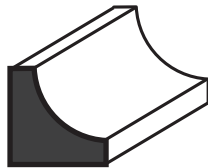

EC 101
1/2"

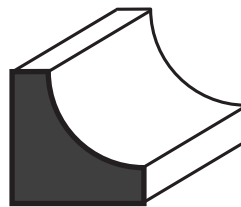

EC 100
11/16"

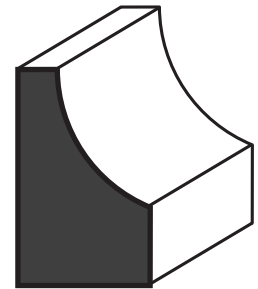

EC 94
1-1/8"



CHAIR RAILS

Including: Rail Backers, Mullions and Panel Moulds



EC 520

5-1/4"

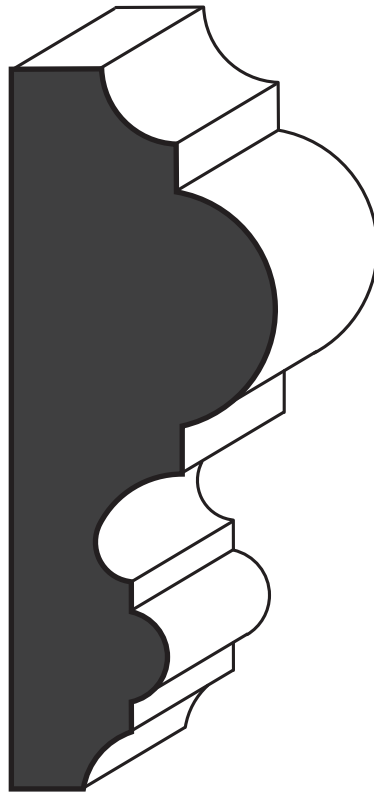

EC 340
3-3/4"

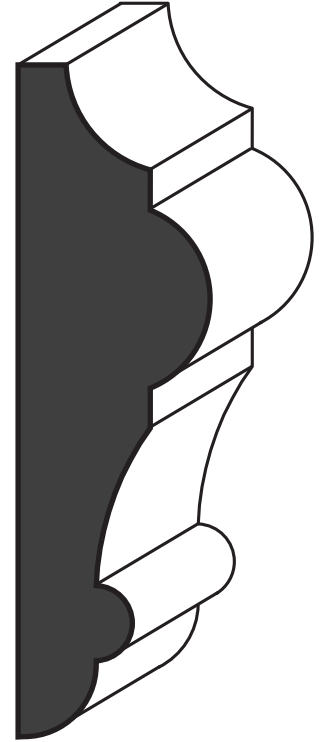

EC 397
3-1/2"



EC 2

3-7/16"



EC 390

2-5/8"



A EC 397 | Chair Rail w/ 1 x 4

B EC 100 | Cove

CHAIR RAILS

Including: Rail Backers, Mullions and Panel Moulds

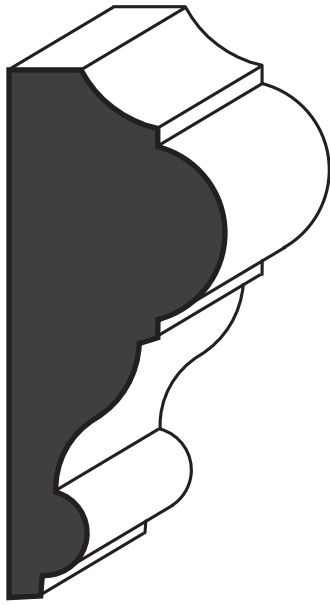

EC 299
2-3/4"
GEARScan
000299

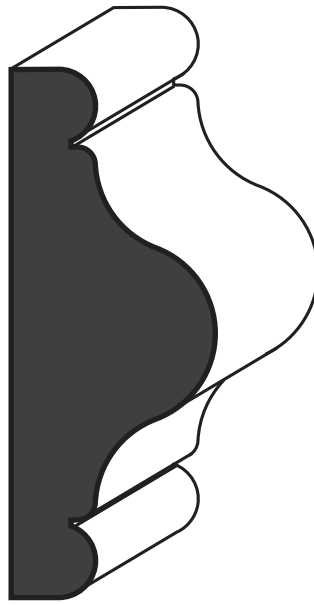

EC 302
2-3/4"
GEARScan
000302

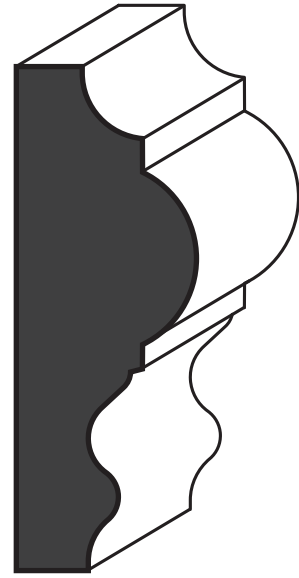

EC 394
2-5/8"
GEARScan
000394



EC 394A
2-5/8"
GEARScan
000395



EC 5
2-5/8"
GEARScan
000005



EC 336
2-1/2"
GEARScan
000336

Including: Rail Backers, Mullions and Panel Moulds

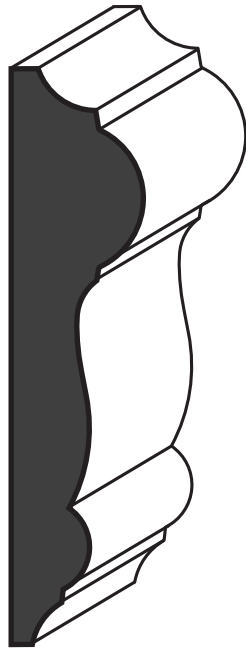

EC 297 | GEARScan
3" | 000297



EC 300 | GEARScan
3" | 000300

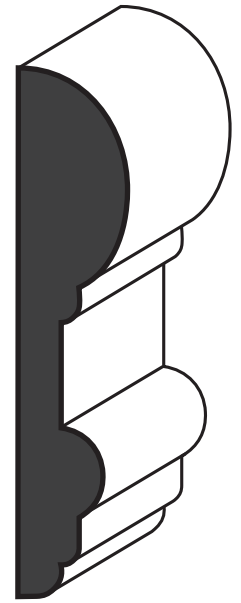

EC 1001 | GEARScan
2-3/4" | 001001

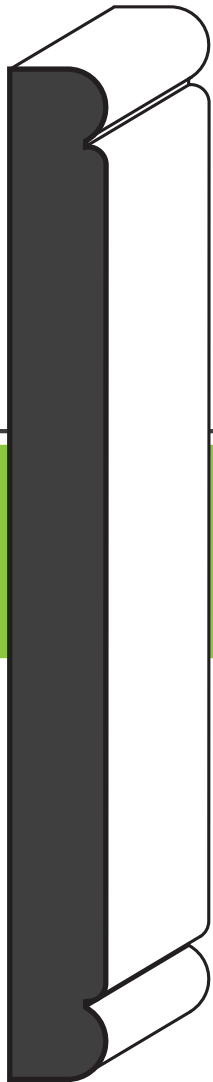

EC 398 | GEARScan
5-1/4" | 000398



EC 425 | GEARScan
4-1/2" | 000425

EC 6 | GEARScan
4-1/2" | 000006

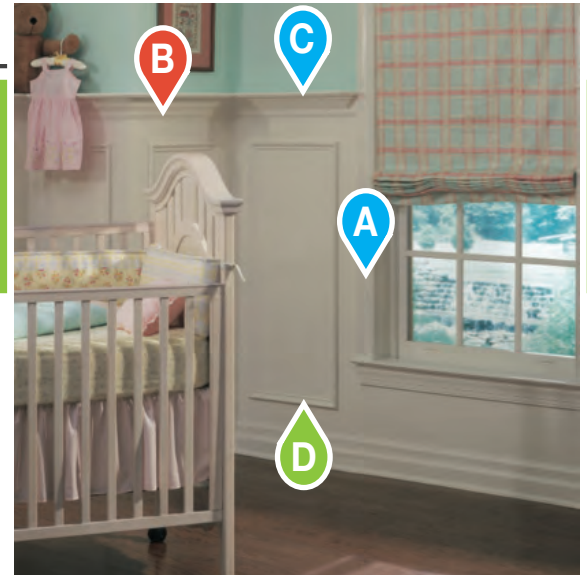

- A** EC 445 | Casing
- B** EC 54 | Crown
- C** EC 1021 | Stool
- D** EC 163 | Panel

CHAIR RAILS

Including: Rail Backers, Mullions and Panel Moulds

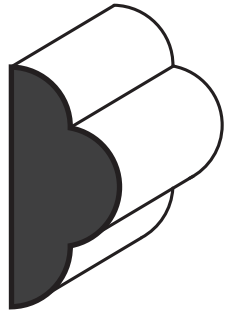

EC 137
1-1/4"
GEARScan
000137



EC 292
1-1/8"
GEARScan
000292

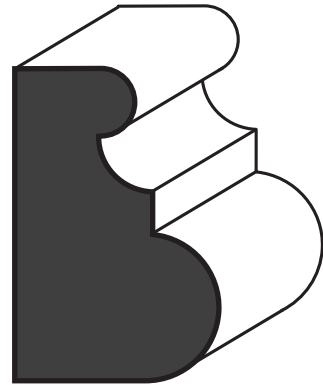

EC 42
1-5/8"
GEARScan
000042



EC 135
1-3/16"
GEARScan
000135



EC 182
1-5/8"
GEARScan
020193



EC 1219
1-5/8"
GEARScan
001219



EC 4234
1-5/8"
GEARScan
004234



EC 139
1-3/16"
GEARScan
000139

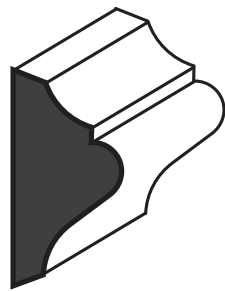

EC 183
1-1/8"
GEARScan
000183



EC 1217
1-1/2"
GEARScan
001219

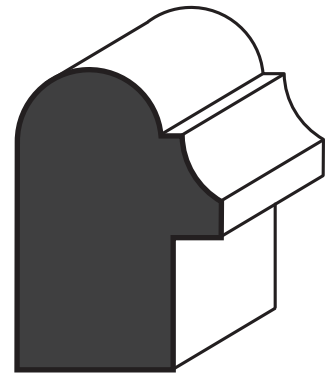

EC 289
1-9/16"
GEARScan
000289

Including: S4S, Screen, Corner Hand Rail, Rake, Shingle, Drip, Corners, Qtr Rounds, and Covers

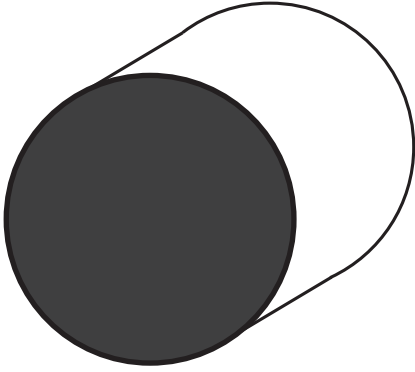

EC 232
1-1/2"
GEARScan
000232

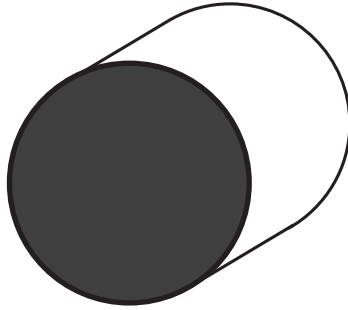

EC 233
1-1/4"
GEARScan
000233

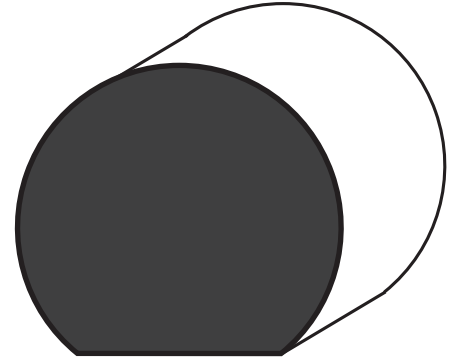

EC 231
1-11/16"
GEARScan
000231

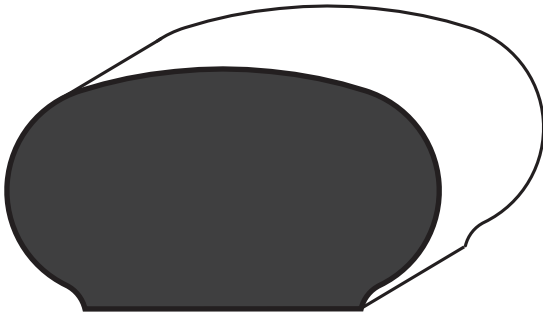

EC 240
2-1/4"
GEARScan
000240

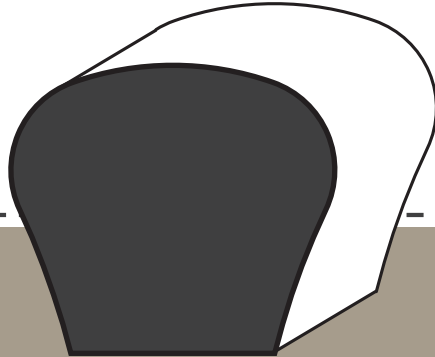

EC 230
1-11/16"
GEARScan
000230

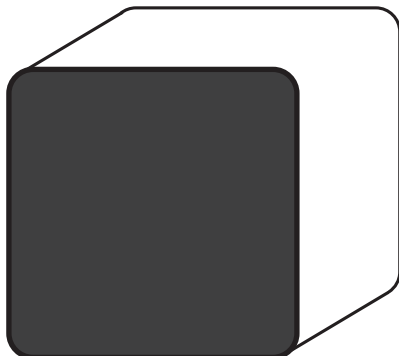

EC 236
1-1/2"
GEARScan
000236



EC 47 | Crown



EC 54 | Crown

MISCELLANEOUS

Including: S4S, Screen, Corner Hand Rail, Rake, Shingle, Drip, Corners, Qtr Rounds, and Coves

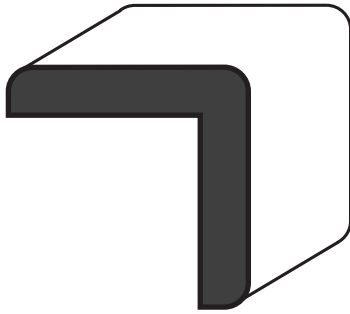

EC 204
1-1/4"
GEARScan
000204



EC 740
1-1/8"
GEARScan
000740

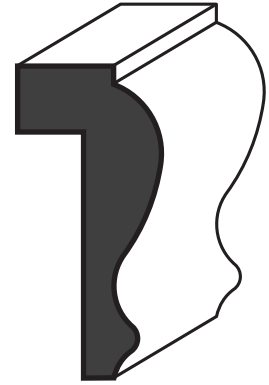

EC 741
1-5/8"
GEARScan
000741

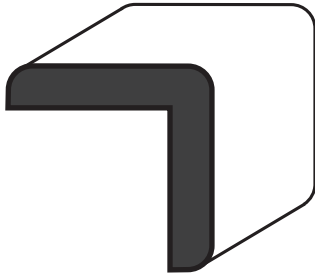

EC 205
1-1/16"
GEARScan
000205

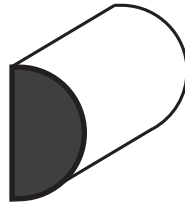

EC 122
1/2"
GEARScan
000122

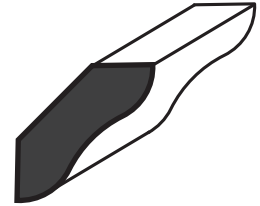

EC 999
1"
GEARScan
000999

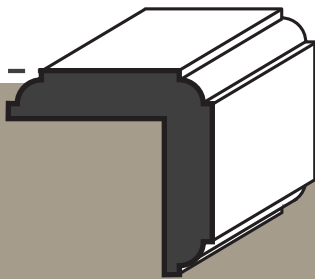

EC 202
1-1/16"
GEARScan
000202

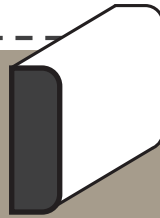

EC 142
3/4"
GEARScan
000142



EC 144
3/4"
GEARScan
000144



EC 206
3/4"
GEARScan
000206

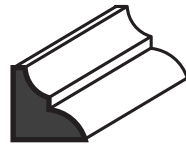

EC 148
3/8"
GEARScan
000148

MISCELLANEOUS

Including: S4S, Screen, Corner Hand Rail, Rake, Shingle, Drip, Corners, Qtr Rounds, and Covers

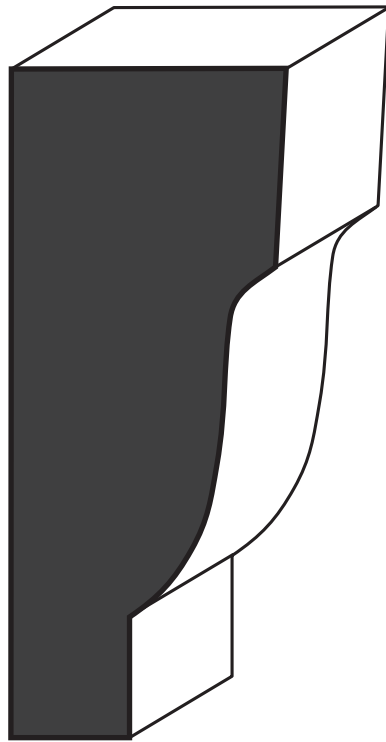

EC 1229
3-1/2"
GEARScan
001229

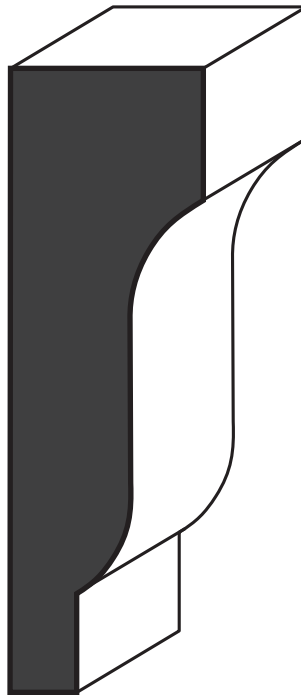

EC 1206
3-1/4"
GEARScan
001206

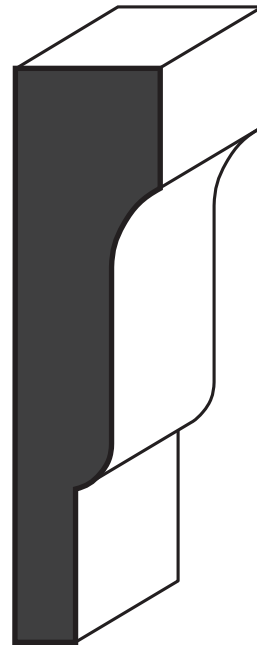

EC 1228
3"
GEARScan
001228

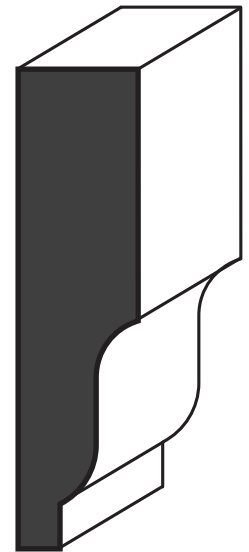

EC 207
2-1/2"
GEARScan
000207



EC 212
2-1/2"
GEARScan
000212

EC 197
1-5/8"
GEARScan
000197

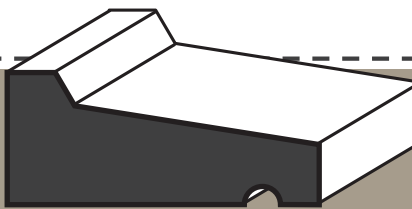

EC 210
1-5/8"
GEARScan
000210

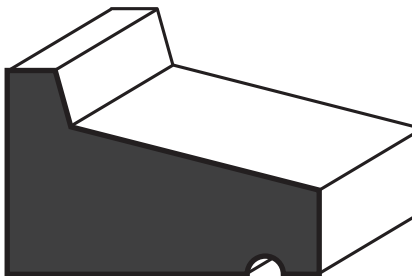
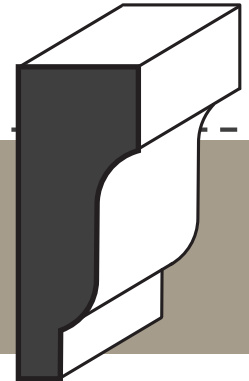

EC 188
1-5/8"
GEARScan
000188

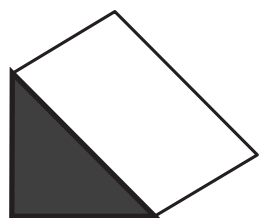

EC 995
3/4"
GEARScan
000995

MISCELLANEOUS

Including: S4S, Screen, Corner Hand Rail, Rake, Shingle, Drip, Corners, Qtr Rounds, and Covets

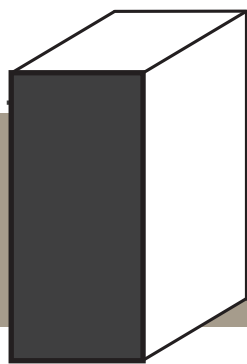
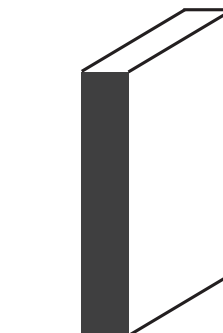
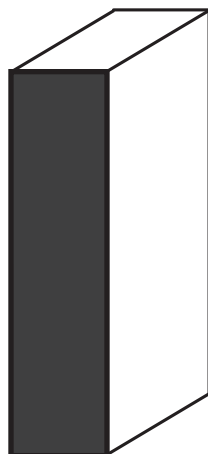
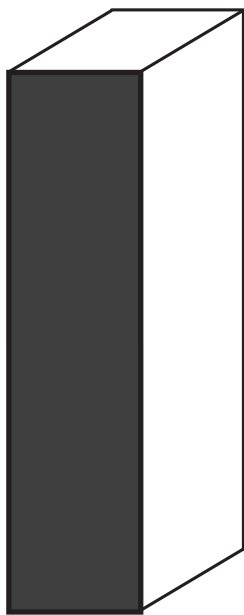

- A** EC 9 | Dentil Crown
- B** EC 163 | Base Cap
- C** EC 5/4 x 6 | S4S
- D** EC 1 | Casing

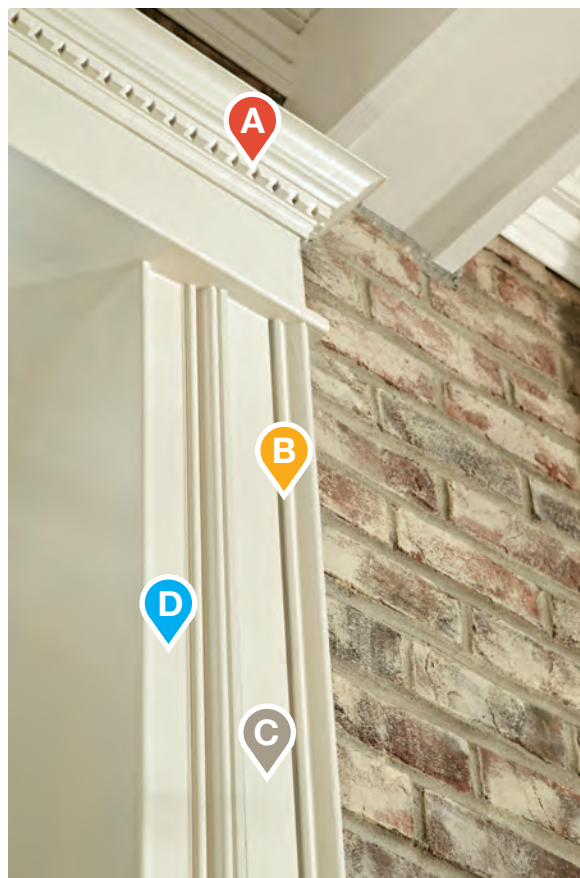

BOARDS AND PANELS

Including: Pattern Stock, S4S Boards and Panels

Square edge also available in these sizes:



EC 1x4
3-1/2"
GEARScan
520004
(DRAWING NOT TO SCALE)

EC 1x2
1-1/2"
GEARScan
520002

EC 1x10
9-1/4"
GEARScan
520010

EC 1x12
11-1/4"
GEARScan
520012



EC 1x6
5-1/2"
GEARScan
520006
(DRAWING NOT TO SCALE)

EC 1x16
15-1/4"
GEARScan
520016

EC 1x18
17-1/4"
GEARScan
520018



EC 1x8
7-1/4"
GEARScan
520008
(DRAWING NOT TO SCALE)

EC 1x24
23-1/4"
GEARScan
520024

Eased edge also available in these sizes:

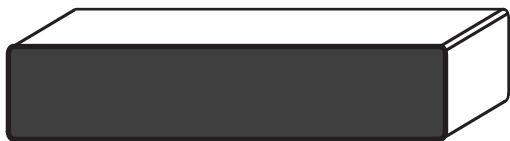

EC 1x4
3-1/2"
GEARScan
522004
(DRAWING NOT TO SCALE)

EC 1x10
9-1/4"
GEARScan
522010

EC 1x12
11-1/4"
GEARScan
522012

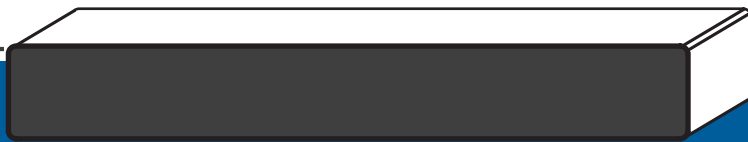

EC 1x6
GEARScan
522006
(DRAWING NOT TO SCALE)



EC 1x8
7-1/4"
GEARScan
522008
(DRAWING NOT TO SCALE)

BOARDS AND PANELS

Including: Pattern Stock, S4S Boards and Panels

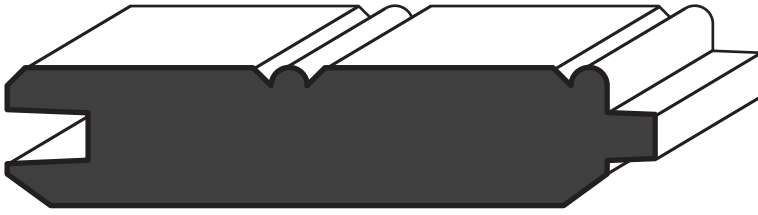

T&G V-JOINT

1 x 4"

GEARScan



010005

T&G V-JOINT

1 x 6"

GEARScan



010004



T&G FLOORING

1 x 4"

GEARScan



010008

T&G FLOORING

1 x 6"

GEARScan



010009



105 SIDING

1 x 6"

GEARScan



010011



WP4

1 x 6"

GEARScan



010017

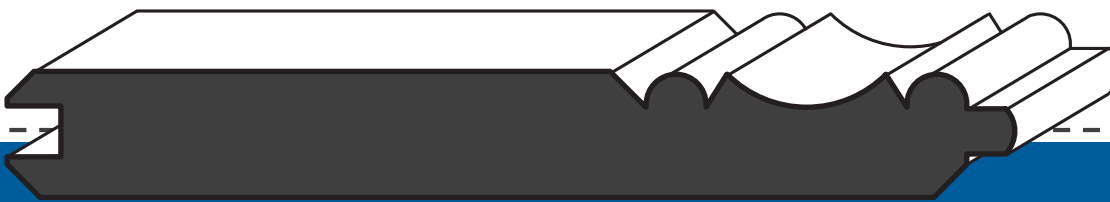

PICKWICK SIDING

1 x 6"

GEARScan



010002

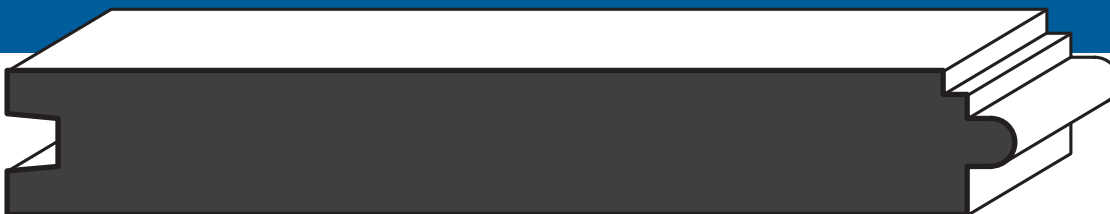

PENNY GAP

1 x 6"

GEARScan



010018

BOARDS AND PANELS

Including: Pattern Stock, S4S Boards and Panels

SIS2E also available in these sizes:



(DRAWING NOT TO SCALE)



(DRAWING NOT TO SCALE)

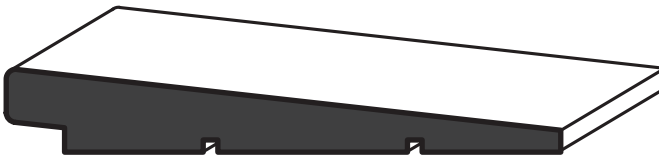

(DRAWING NOT TO SCALE)

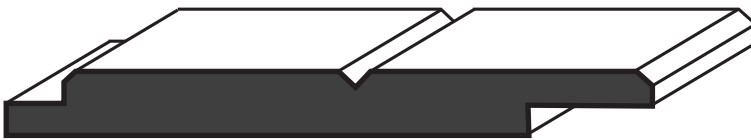

(DRAWING NOT TO SCALE)

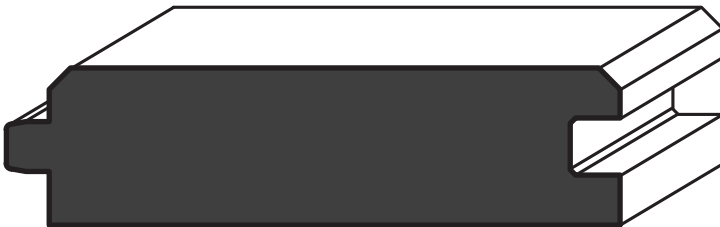

(DRAWING NOT TO SCALE)



(DRAWING NOT TO SCALE)

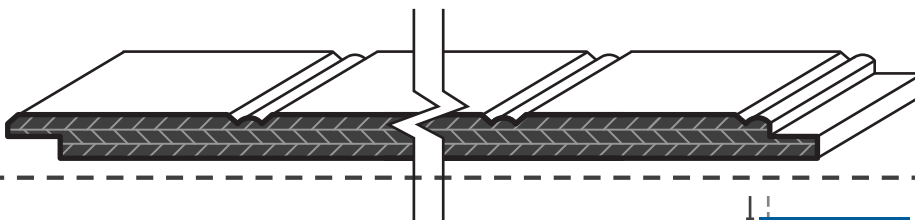

(DRAWING NOT TO SCALE)



Moulding Tips & Suggestions

The most visually pleasing crown and base mouldings are applied in proportion to the ceiling height.

Suggestions for 8 ft. ceiling heights

- 2-1/4 in. - 3-5/8 in. crown mouldings
- 3-1/4 in. - 5-1/4 in. base mouldings

Suggestions for 9 ft. ceiling heights

- 4-1/4 in. - 5-1/2 in. crown mouldings
- 4-1/4 in. - 6-1/8 in. base mouldings

Suggestions for 10 ft. ceiling heights

- 5-1/4 in. - 7-1/4 in. crown mouldings
- 5-1/4 in. - 9-1/4 in. base mouldings

Greater than 10 ft. ceiling heights

- Lots of opportunities for compound crowns and bases to achieve the desirable look.

Again, scale the dimensions proportional to the living space.

Door and window casings are influenced by the ceiling heights but are also selected according to door heights.

- Door heights of 6 ft. 8 in. - 2-1/4 in. - 3-1/2 in. casing
- Door heights of 7 ft. - 2-1/2 in. - 4 in. casing
- Door heights of 8 ft. - 3-1/2 in. and larger

Base caps offer a decorative transition from the S4S base to the wall. Base caps are also commonly used to design wainscoting panels for less expense.

Chair rails should be installed at the height to protect the wall at the height of your chair back. Decoratively, chair rails break up a room creating an opportunity for multiple color schemes or panel options.

Picture mould was historically used to hang pictures from when walls were plaster and difficult to drive nails into. Today, picture moulding is frequently used as an extension of the crown, enhancing the wall treatment.

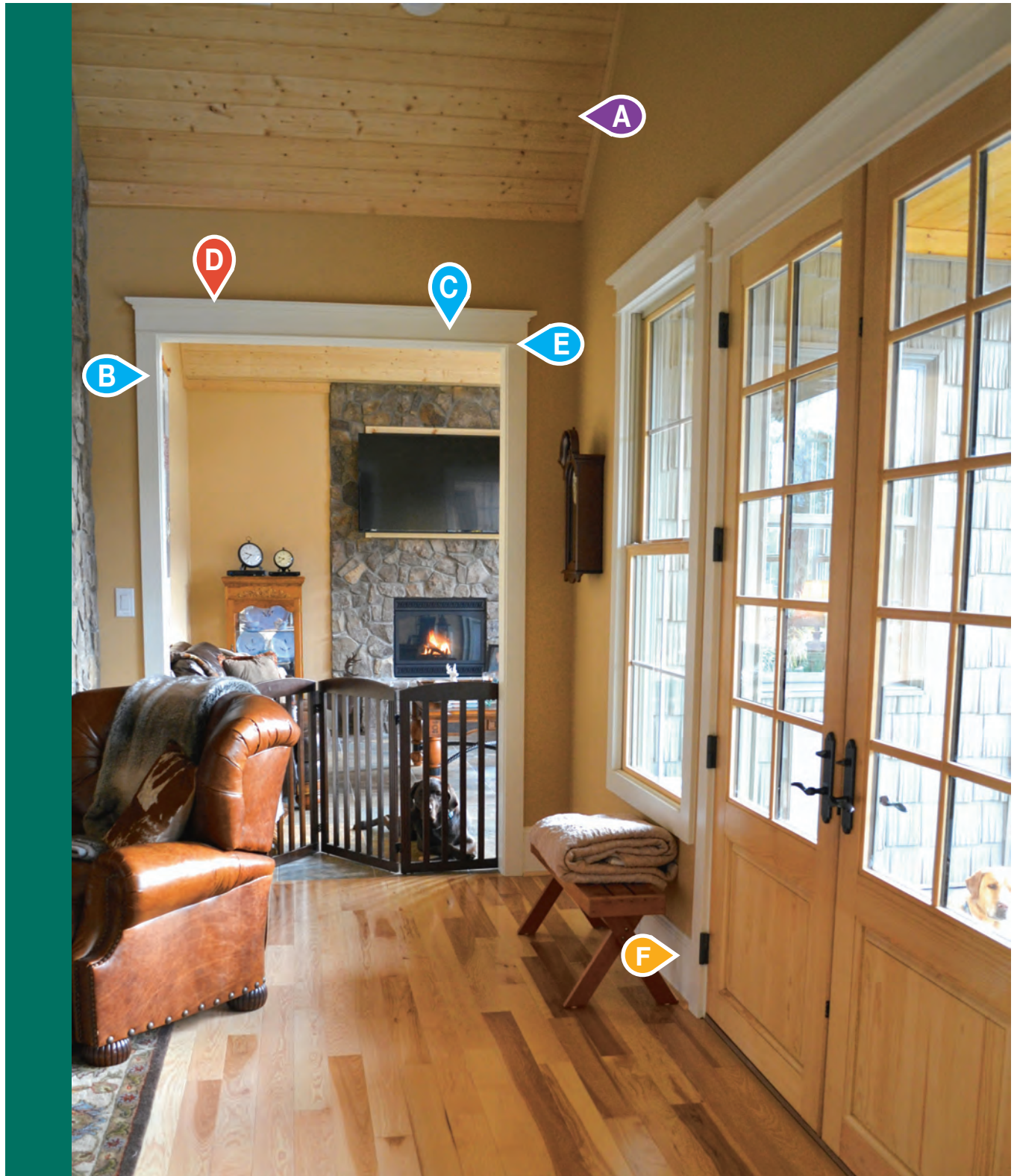

A Spruce ECB | Ceiling

E EC 887 | Casing

B 1 x 4 | Casing

F EC 810 | Base

C 1 x 6 | Header

D EC 3609 | Crown

Moulding designs should complement the architectural design of your home and your furnishings.

Below is an illustrated guide with suggestions on how to pair mouldings best suited for the dimensions of a room.

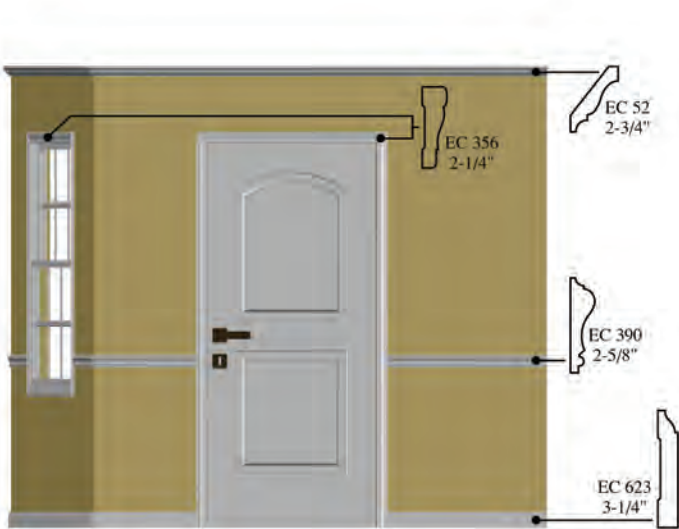

8 ft. Ceiling with a 6 ft. 8 in. Door

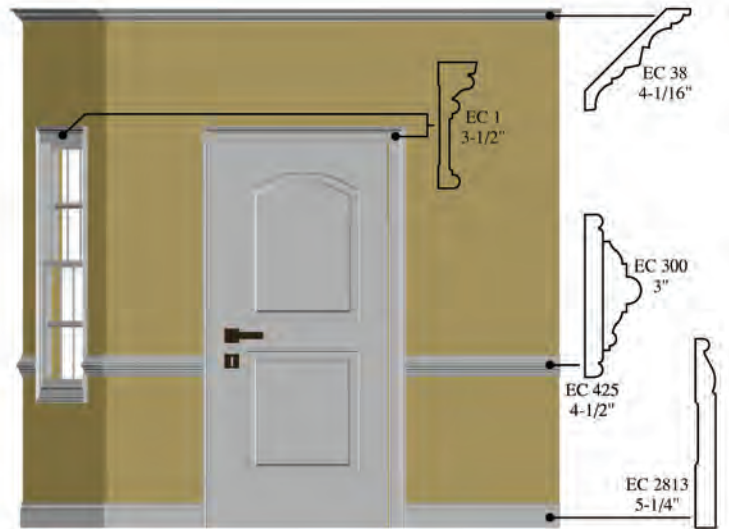

9 ft. Ceiling with a 6 ft. 8 in. Door

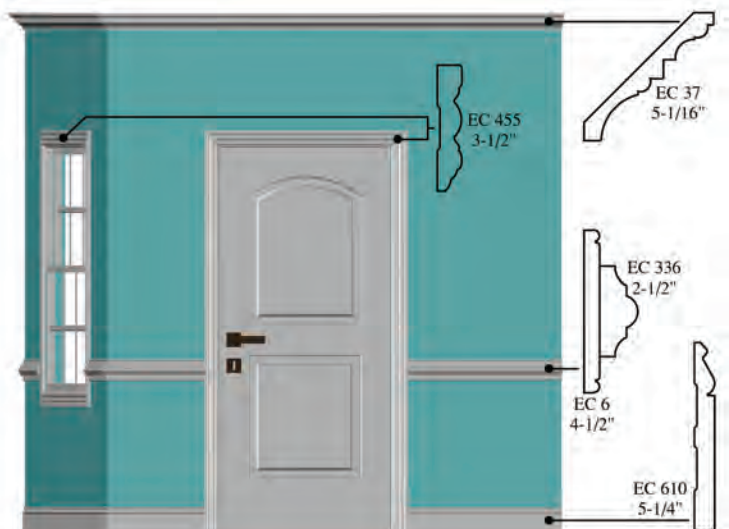
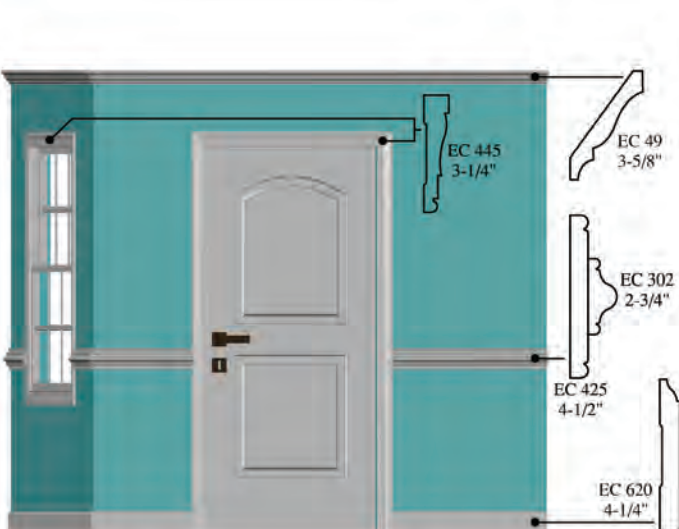

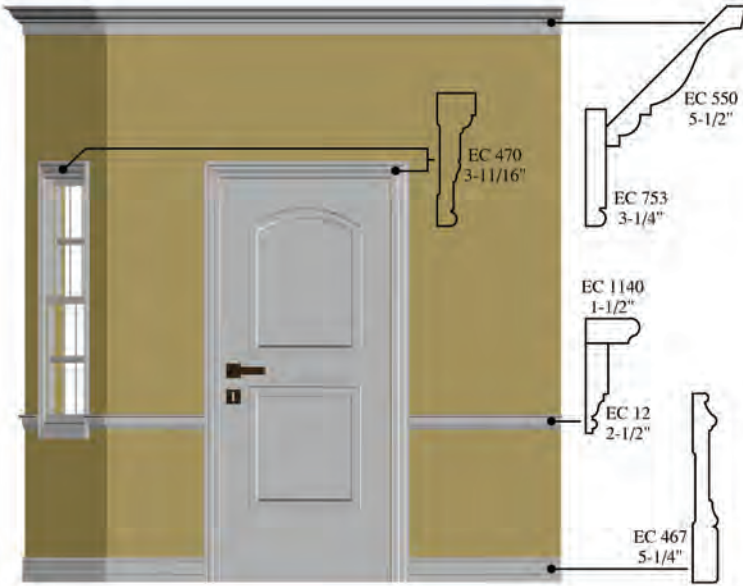

10 ft. Ceiling with a 7 ft. Door

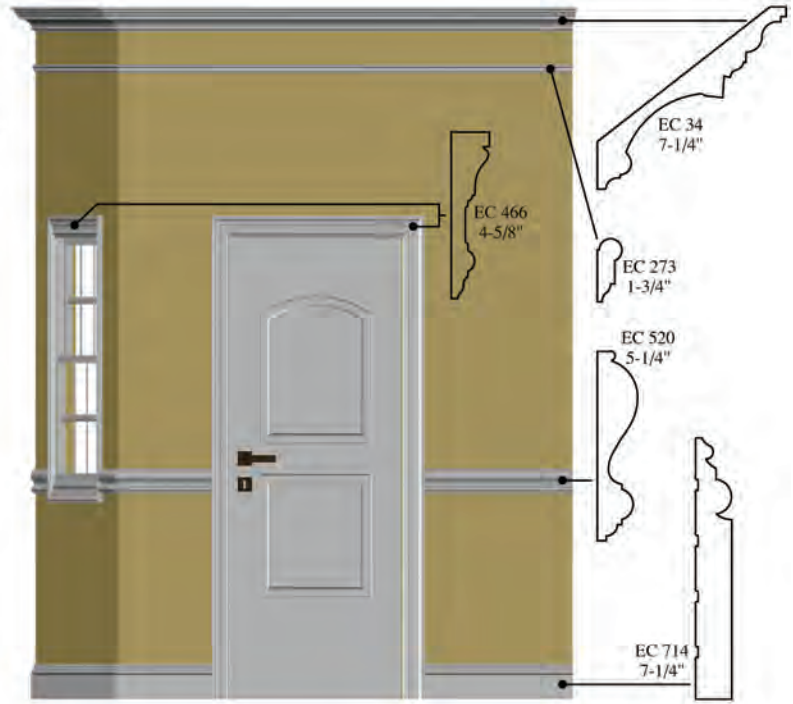

12 ft. Ceiling with an 8 ft. Door

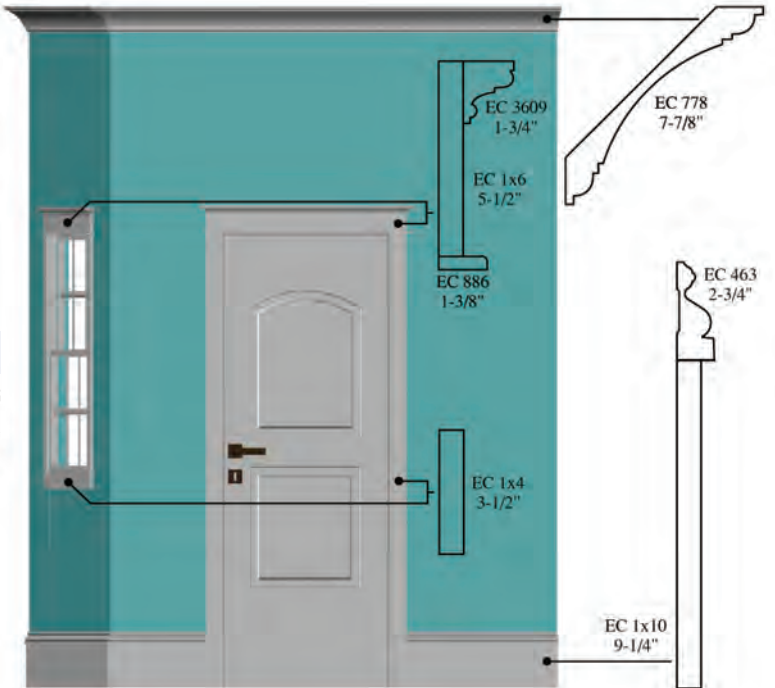
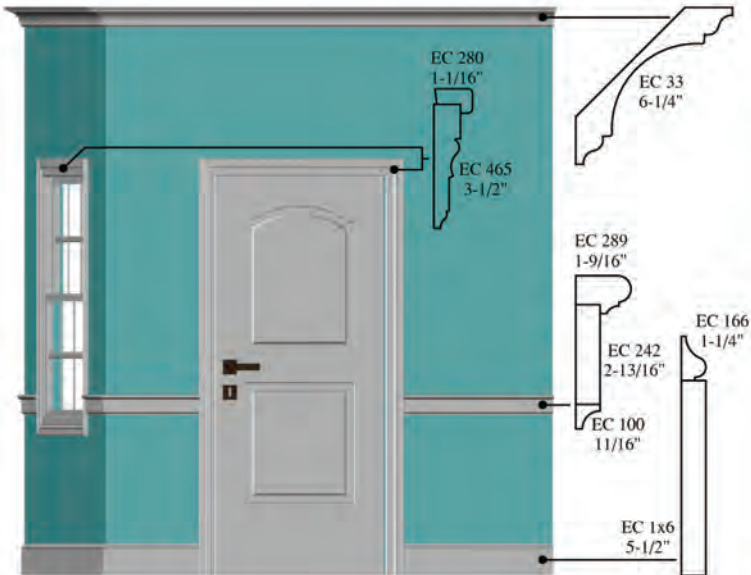

PRODUCT SELECTION GUIDE

Profile	Type	Stock	Page	Profile	Type	Stock	Page	Profile	Type	Stock	Page
EC 1	Casing	F, P, M, S	16	EC 60	Crown	S	4	EC 205	Corner	S, O	36
EC 2	Chair	S	31	EC 61	Crown	S, M	9	EC 206	Corner	S, O	36
EC 3	Dentil	S	8	EC 68	Crown	S, F, P	10	EC 207	Shingle	P	37
EC 3	Dentil Insert	S	8	EC 70	Crown	P	4	EC 210	Shingle	F, P	37
EC 4	Casing	M	15	EC 74	Crown	S, P	4	EC 212	Shingle	P	37
EC 5	Chair	S	32	EC 75	Crown	S, P	5	EC 230	Handrail	S	35
EC 6	Backer	S	33	EC 80	Cove	M	6	EC 231	Handrail	S	35
EC 8	Dentil	S	8	EC 81	Cove	M	6	EC 232	Full Rd.	H	35
EC 9	Dentil	P, S	8	EC 84	Cove	S	6	EC 233	Full Rd.	H	35
EC 12	Apron	F, P, M	16	EC 85	Cove	S	6	EC 236	S4S	S	35
EC 13	Dentil	S	8	EC 94	Cove	S	30	EC 240	Handrail	S	35
EC 14	Casing	P, S	19	EC 100	Cove	S, O, P	30	EC 242	S4S	F, P	38
EC 18	Crown	F	9	EC 101	Cove	S	30	EC 247	S4S	S	38
EC 19	Base	P	30	EC 103	Qtr. Rd.	S	27	EC 248	S4S	S	38
EC 20	Casing	F, P	16	EC 105	Qtr. Rd.	S	27	EC 249	S4S	S	38
EC 24	Crown	P	7	EC 106	Qtr. Rd.	S, P	27	EC 254	S4S	S	38
EC 25	Rosette	S	20	EC 108	Qtr. Rd.	S	27	EC 266	S4S	S	38
EC 26	Plinth	S	20	EC 122	Half Rd.	S	36	EC 267	S4S	S	38
EC 28	Rosette	S	20	EC 126	Shoe	S, O, P	27	EC 273	Picture	S, P, F	9
EC 29	Rosette	S	20	EC 127	Shoe	S, P	27	EC 280	B. Band	S	14
EC 30	Rosette	S, O	20	EC 135	Chair	P	34	EC 281	B. Band	S, F	14
EC 33	Crown	M	7	EC 137	Chair	S, P	34	EC 282	B. Band	P	13
EC 34	Crown	M	8	EC 139	Chair	P	34	EC 283	B. Band	P	14
EC 35	Crown	M	12	EC 142	Screen	S	36	EC 284	B. Band	F	13
EC 36	Crown	M	5	EC 144	Screen	S	36	EC 284A	B. Band	F	13
EC 36A	Crown	M	5	EC 148	Glass Bd.	S	36	EC 289	Panel	S	34
EC 37	Crown	F, P, M, S	8	EC 150	Base Cap	P	7	EC 292	Chair	S	34
EC 38	Crown	F	8	EC 154	Base Cap	P	12	EC 297	Chair	S, F	33
EC 39	Crown	P	7	EC 162	Base Cap	O	24	EC 299	Chair	P	32
EC 40	Crown	P, S	6	EC 163	Base Cap	S, P, M	25	EC 300	Chair	S, P, F	33
EC 41	Crown	M, S	10	EC 164	Base Cap	S	25	EC 302	Chair	P	32
EC 42	Panel	P	34	EC 166	Base Cap	S	25	EC 310	Base	M	25
EC 45	Crown	S, F, P, M	11	EC 167	Base Cap	S	25	EC 327	Casing	S, F, P	17
EC 46	Crown	F	10	EC 172	Base Cap	S	25	EC 336	Chair	F, P	32
EC 47	Crown	S, F, P, M, O	11	EC 180	Brick	S, F, P	21	EC 340	Chair	P	31
EC 48	Crown	F, P, M	11	EC 182	Panel	P	34	EC 350	Casing	M	15
EC 49	Crown	S, F, P, M	11	EC 183	Chair	S	34	EC 351	Casing	S	17
EC 50	Crown	P, M	7	EC 188	Drip	P	37	EC 356	Casing	S, F, P, M, O	17
EC 51	Crown	S, P, M, O	11	EC 190	Brick	P	13	EC 361	Casing	S, F, P	18
EC 52	Crown	S, F, P	11	EC 197	Drip Cap	S, P	37	EC 366	Casing	S, F, P, M	18
EC 54	Crown	S, P, O	10	EC 202	Corner	S	36	EC 371	Casing	F	15
EC 58	Crown	S	4	EC 204	Corner	S	36	EC 376	Casing	S, F, P, M	15

F = FJ, Raw P = FJ Primed M = Primed MDF S = Solid Pine O = Oak H = Poplar
R = Raw U = Spruce L = Alder C = Inland Red Cedar A = Maple Y = Cypress

PRODUCT SELECTION GUIDE

Profile	Type	Stock	Page	Profile	Type	Stock	Page	Profile	Type	Stock	Page
EC 387	Casing	S, P	17	EC 623	Base	S, F, P, M	26	EC 990	Mullion	S	22
EC 390	Chair	S, F, P	31	EC 623A	Base	O	27	EC 995	Chamfer	S	37
EC 394	Chair	S	32	EC 625	Base	M	22	EC 999	Cove	S	36
EC 394A	Chair	F	32	EC 631	Base	S, P	26	EC 1001	Chair Rail	F	33
EC 397	Chair	S, P, M	31	EC 663	Base	S, P	27	EC 1002	Casing	F	19
EC 398	Chair	P, M	33	EC 683	Casing	S, P	17	EC 1006	Casing	F	19
EC 401	Casing	F, P	16	EC 700	Base	P	30	EC 1021	Stool	S, F, P, M	23
EC 402	Casing	P	16	EC 705	Base	P	30	EC 1121	Stool	P	23
EC 405	Casing	P	18	EC 710	Base	S	29	EC 1140	Stool	S	22
EC 412	Casing	P	13	EC 713	Base	S, F, P	29	EC 1162	Stool	S, P	22
EC 414	Casing	P	13	EC 714	Casing	F	19	EC 1163	Stool	S	22
EC 425	Backer	F, P	33	EC 714B	Base	M	28	EC 1164	Stool	S, F	22
EC 433	Casing	F	18	EC 714	Crown	M	12	EC 1195	Stool	S, F	22
EC 436	Casing	P	14	EC 718	Crown	M	4	EC 1206	Shingle	P	37
EC 442	Casing	S, F, P, M	18	EC 734	Crown	M	12	EC 1217	Chair	S	34
EC 444	Casing	S, F, P, M	17	EC 738	Crown	M	9	EC 1219	Chair	S	34
EC 444A	Casing	S	17	EC 740	Cabinet	S	36	EC 1228	Rake	P	37
EC 445	Casing	S, F, P, M, O	15	EC 741	Cabinet	S	36	EC 1229	Rake	P	37
EC 445A	Casing	F	15	EC 750	Base	S, P	29	EC 1300	Astragal	S	21
EC 446	Casing	P	14	EC 751	Base	S, P	29	EC 1305	Astragal	S	21
EC 453	Casing	P	14	EC 753	Base	S, P	29	EC 2805	Base	P	28
EC 455	Casing	F, P	16	EC 755	Casing	F	17	EC 2808	Base	P	28
EC 458	Crown	M	5	EC 778	Crown	M	6	EC 2813	Base	P	28
EC 460	Casing	F, P, M	14	EC 810	Base	S, F, P, M	24	EC 3609	Crown	P	9
EC 463	Casing	F	16	EC 814	Crown	M	5	EC 4234	Panel	S, F	34
EC 464	Casing	F	15	EC 816	Stop	S	21	EC 5180	Base	P, M	30
EC 465	Casing	P	18	EC 817	Stop	S	21				
EC 466	Casing	P	13	EC 818	Crown	M	9	<u>Boards and Patterns</u>	<u>Stock</u>	<u>Page</u>	
EC 467	Base	F, M	27	EC 838	Crown	M	4	S4S	F, P, M, S, O, H	39	
EC 470	Casing	F, P	15	EC 886	Stop	S	21		A, L, R, Y, U, E, J		
EC 473	Casing	F	18	EC 910	Base	M	24	T&G V-Joint ECB	P, S, Y, U	40	
EC 480	Casing	P	16	EC 935	Stop	S	21	Pickwick	S	40	
EC 501	Crown	M	7	EC 936	Stop	S	21	Flooring	S	39	
EC 514	Casing	F	19	EC 937	Stop	S	21	105 Siding	S	40	
EC 520	Chair Rail	F	31	EC 940	Stop	S	21	Eased-Edge S4S	U, M, I	41	
EC 545	Casing	P	19	EC 941	Stop	S	21	S1S2E	C, Y	41	
EC 550	Crown	M	4	EC 941A	Stop	S	21	S1S2E Bevel	C, Y	41	
EC 610	Base	S, F, P, M	25	EC 972	Mullion	S	23	S1S2E RBT Bevel	C	41	
EC 616	Base	S, F, M	24	EC 987	Mullion	S	23	WP4	C, Y	40	
EC 618	Base	S, F, P, M	26	EC 988	Mullion	S	23	Channel	C	41	
EC 620	Base	S, F, P, M	26	EC 988A	Mullion	S	23	Decking	U	41	
EC 620A	Base	O	27	EC 989	Mullion	S	23	Penny Gap	M	40	

F = FJ, Raw P = FJ Primed M = Primed MDF S = Solid Pine O = Oak H = Poplar
R = Raw U = Spruce L = Alder C = Inland Red Cedar A = Maple Y = Cypress

CROWN

DOOR & WINDOW

BASE

CHAIR RAIL

MISC.

BOARD & PANEL

| Sales and Customer Service |

| ECMD Corporate Office |

| 2 Grandview Street |

| North Wilkesboro, NC 28659 |

| T: 888.222.3961 |

| F: 866.314.0747 |

| www.eastcoastmouldings.com |

EastCoast[®]
Mouldings