

Arndt & Herman

BUILDING PRODUCTS®



Exterior Vinyl Railings

SOLUTIONS

- Series 3000 and 3250
- Highest quality low-maintenance PVC
- Quick snap screw covers
- Easy-to-assemble components
- ADA compliant secondary rail
- Series 3000
ICC approved - ESR-1912
- Stair sections with multiple angles
- Choice of post, baluster and cap styles
- Weather-resistant system prevents cracking, rotting, splitting or rusting
- Posts and accessories work with either system
- Series 3250
NES approved NER#571

Vinyl Railing Systems

Table of Contents

Column Cladding	2	Series 3250 Stair Rail Kits	7	4" Fluted Porch Posts	12
Structural Posts and Sleeves	3	Series 3000 Specialty Brackets	8	Railings and Green-Clad Rail Kits	13
Series 3000 Level Rail Kits	4	Series 3250 Specialty Brackets	9	Screen Clad System	14, 15
Series 3000 Stair Rail Kits	5	Column Cladding Accessories	10	Gate Kits	16
Series 3250 Level Rail Kits	6	Base Trim and Post Caps	11	Secondary Handrail	16

Arndt & Herman Vinyl Railings

- Engineered and designed to work together
- Quick snap screw covers (Series 3000)
- Easy to use, come in kits
- Stair sections with multiple angles
- Contemporary or Colonial look
- Installs quickly, saves time
- Highest quality low-maintenance PVC
- ADA compliant secondary rail
- Backed by the Arndt & Herman name

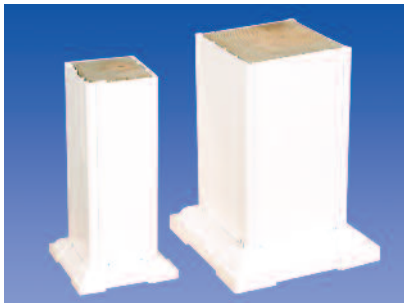

4" and 6" Smooth Cladding

Column Cladding

For load bearing, full height posts where it is not feasible to cover 4x4, 6x6 or 8x8 wood posts with a sleeve, use our 4-piece Column Cladding to cover the wood. Available in smooth or fluted in 8.5' and 10' heights. Ideal for retrofit or remodel applications.

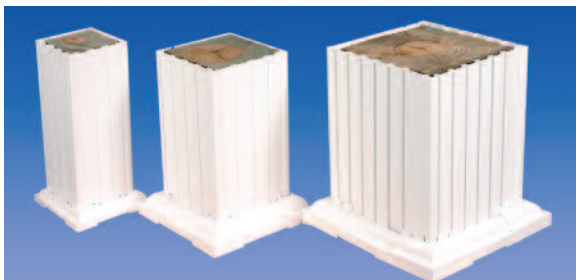

4", 6" and 8" Fluted Cladding

Smooth Cladding	8.5' Long		10' Long	
	White	Beige	White	Beige
For 4" Post	602408W	602408B	602410W	602410B
For 6" Post	602608W	602608B	602610W	602610B

Fluted Cladding	8.5' Long		10' Long	
	White	Beige	White	Beige
For 4" Post	604408W	604408B	604410W	604410B
For 6" Post	604608W	604608B	604610W	604610B
For 8" Post	604808W	604808B	604810W	604810B



Series 3250 Railing, Fluted Column Cladding

Colonial Newel Post

For the same colonial elegance found in our Porch Post, use a Colonial Newel Post. Use 38" newel for 36" high level rails and use the 54" newel for 36" stair rails, 42" level rail and 42" stair rails. Comes with hardware for wood mount, masonry mount, shims, plain cap and base and gasket for ACQ lumber.



4" Colonial Newel Post
60138W 60154W

Colonial Porch Post

For added elegance and durability, use our 5" Colonial Porch Post. Load bearing up to 7,400 pounds and reinforced with aluminum tubing. Turnings match those on 1.5" colonial balusters. Comes with top and bottom mounting plates and screws for wood or masonry mounting.



Colonial Porch Post
5" x 104"
60159W 60159B
5" x 108"
60160W 60160B

Utility Flush Mount Posts

Arndt & Herman Utility Posts offer the advantage of screwing brackets to a post without pre-drilling the post. Available in 4" size. Use 38" post for 36" high level rails, use 44" post for 42" level rails and use 54" post for landings and some stair railings. Comes with hardware for wood mount, masonry mount, shims and gasket for ACQ lumber. Finish by covering with vinyl sleeve and post cap of your choice. Also available in kit form with plain cap, base and white sleeve.



Utility Flush Mount Post
601438U 601444U 601454U
Kit 601438UKW
Kit 601444UKW
Kit 601454UKW

Vinyl Sleeves

Many railing systems are installed on wood decks or porches where 4x4 or 6x6 wood posts are used. Use our 4" or 6" Vinyl Sleeves to cover wood posts. Available in 38", 54" and 108" lengths.

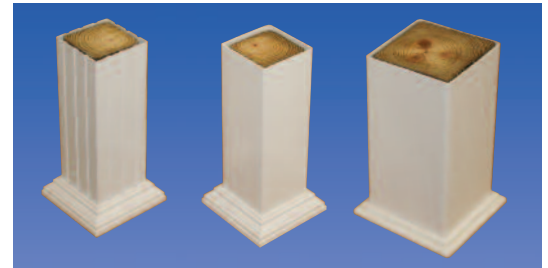

4" and 6" Vinyl Post Sleeves

Size	White Plain	Beige Plain	White Fluted	Beige Fluted
4" x 38"	60238W	60238B	60438W	60438B
4" x 54"	60254W	60254B	60454W	60454B
4" x 108"	60208W	60208B	60408W	60408B
4" x 120"	60220W			
6" x 38"	60338W	60338B		
6" x 54"	60354W	60354B		
6" x 108"	60308W	60308B		
6" x 120"	60320W			

Flush Mount Posts

Arndt & Herman Flush Mount Posts come in 4" and 6" sizes. Use 36" height for residential applications and 42" height for commercial applications. Ideal for concrete or other solid surfaces. Aluminum "H" beam is finished by covering with a vinyl sleeve and post cap. No hardware included.



4" and 6" Flush Mount Posts

Size	36" High	42" High
4" Post	601436F	601442F
6" Post	601636F	601642F

Series 3000 Level Railings

Arndt & Herman Series 3000 vinyl railing is an attractive, long-lasting and easy-to-use system that is packaged in convenient kits. It is extruded from 100% U.V. stabilized, high impact rigid PVC and meets the structural requirements of the International Building Code (IBC). Each kit contains the appropriate length of top and bottom rails, and all of the necessary balusters, mounting brackets, bottom rail supports, quick snap screw covers, hardware and installation instructions.

ESR #1912

Approved by ICC Evaluation Service.

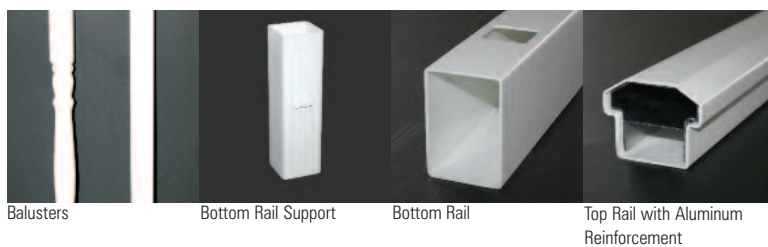
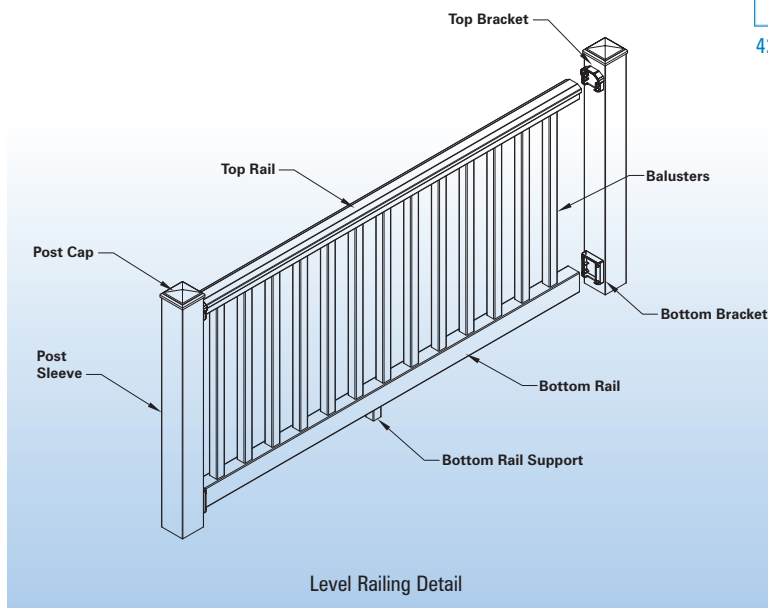

Residential Level Railing Kits

Square Baluster 1-1/2"	White	Beige
4' Level Railing Kit - Square	62504W	62504B
6' Level Railing Kit - Square	62506W	62506B
8' Level Railing Kit - Square	62508W	62508B
10' Level Railing Kit - Square	62510W	62510B
Turned Baluster 1-1/2"	White	Beige
4' Level Railing Kit - Turned	62604W	62604B
6' Level Railing Kit - Turned	62606W	62606B
8' Level Railing Kit - Turned	62608W	62608B
10' Level Railing Kit - Turned	62610W	62610B

36" handrail height with 2" deck clearance

Commercial Level Railing Kits

Square Baluster 1-1/2"	White	Beige
4' Level Railing Kit - Square	6250442W	6250442B
6' Level Railing Kit - Square	6250642W	6250642B
8' Level Railing Kit - Square	6250842W	6250842B
10' Level Railing Kit - Square	6251042W	6251042B

42" handrail height with 2" deck clearance



Series 3000 Railing, Round Fiberglass Columns

Series 3000 Stair Railings

Residential Stair Railing Kits		
Square Baluster 1-1/2"	White	Beige
6' Stair Railing Kit - Square - 29°-35°	625296W	625296B
8' Stair Railing Kit - Square - 29°-35°	625298W	625298B
6' Stair Railing Kit - Square - 36°-41°	625366W	625366B
8' Stair Railing Kit - Square - 36°-41°	625368W	625368B
Turned Baluster 1-1/2"	White	Beige
6' Stair Railing Kit - Turned - 29°-35°	626296W	626296B
8' Stair Railing Kit - Turned - 29°-35°	626298W	626298B
6' Stair Railing Kit - Turned - 36°-41°	626366W	626366B
8' Stair Railing Kit - Turned - 36°-41°	626368W	626368B

36" handrail height with 2" deck clearance



Series 3000 Railing, Colonial Porch Post

Commercial Stair Railing Kits		
Square Baluster 1-1/2"	White	Beige
6' Stair Railing Kit - Square - 29°-35°	62529642W	62529642B
8' Stair Railing Kit - Square - 29°-35°	62529842W	62529842B
6' Stair Railing Kit - Square - 36°-41°	62536642W	62536642B
8' Stair Railing Kit - Square - 36°-41°	62536842W	62536842B

42" handrail height with 2" deck clearance



Bottom Rail Stair Bracket with Screw Covers

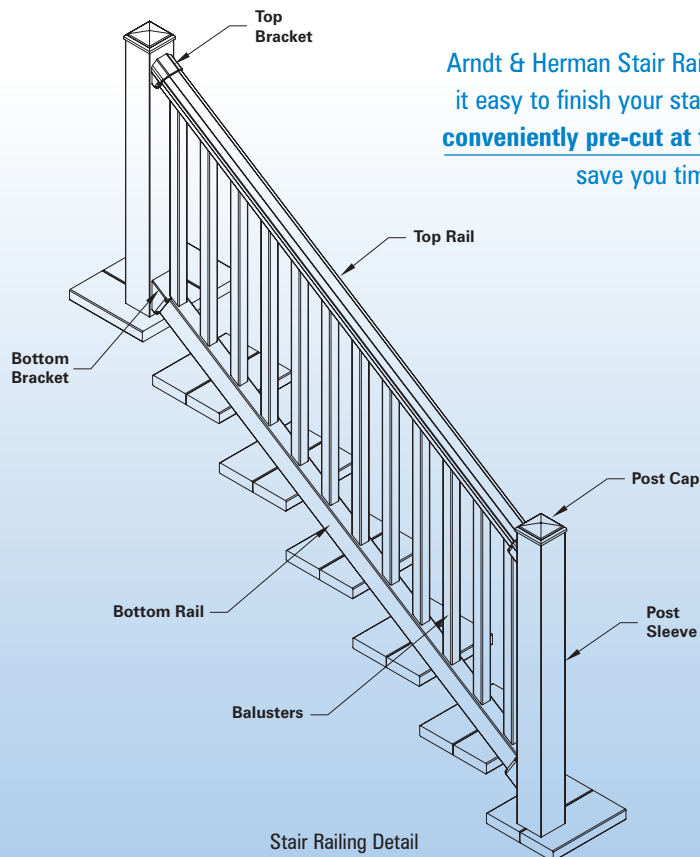

Arndt & Herman Stair Railing kits make it easy to finish your stairs. Each kit is **conveniently pre-cut at the factory** to save you time and money.



Top Rail Stair Bracket with Screw Covers



Top Rail Stair Bracket with Screw Covers

Series 3250 Level Railings

Arndt & Herman Series 3250 Vinyl Railing is a fine contrast to the Series 3000. The 3250 boasts a large, multi-shadow-line top rail and hefty bottom rail. Extruded from the same 100% U.V. stabilized, high impact rigid PVC, this rail system is one of the strongest in the marketplace. Each kit contains the appropriate length of top and bottom rails, all the necessary balusters, mounting brackets, bottom rail supports, hardware and installation instructions.

NER#571

Approved by National Evaluation Service



Series 3250 Railing, Colonial Porch Posts

Residential Level Railing Kits

Turned Baluster 1-1/2"	White
4' Level Railing Kit - Turned	61604W
6' Level Railing Kit - Turned	61606W
8' Level Railing Kit - Turned	61608W
10' Level Railing Kit - Turned	61610W

36" handrail height with 2" deck clearance

Commercial Level Railing Kits

Fluted Baluster 1-3/4"	White
4' Level Railing Kit - Fluted	6170442W
6' Level Railing Kit - Fluted	6170642W
8' Level Railing Kit - Fluted	6170842W
10' Level Railing Kit - Fluted	6171042W

42" handrail height with 2" deck clearance

Residential Level Railing Kits

Fluted Baluster 1-3/4"	White
4' Level Railing Kit - Fluted	61704W
6' Level Railing Kit - Fluted	61706W
8' Level Railing Kit - Fluted	61708W
10' Level Railing Kit - Fluted	61710W

36" handrail height with 2" deck clearance



Fluted Baluster

Bottom Rail Support

Bottom Rail

Top Rail with Aluminum Reinforcement



Series 3250 Railing
4" Vinyl Post Sleeve

Series 3250 Stair Railings



Series 3250 Porch Railing,
Round Fiberglass Columns

Commercial Stair Railing Kits

Fluted Baluster 1-3/4"	White
6' Stair Railing Kit - Fluted - 29°-35°	61729642W
8' Stair Railing Kit - Fluted - 29°-35°	61729842W
6' Stair Railing Kit - Fluted - 36°-41°	61736642W
8' Stair Railing Kit - Fluted - 36°-41°	61736842W

42" handrail height with 2" deck clearance

Residential Stair Railing Kits

Turned Baluster 1-1/2"	White
4' Stair Railing Kit - Turned - 29°-35°	616294W
6' Stair Railing Kit - Turned - 29°-35°	616296W
8' Stair Railing Kit - Turned - 29°-35°	616298W

36" handrail height with 2" deck clearance

Residential Stair Railing Kits

Fluted Baluster 1-3/4"	White
4' Stair Railing Kit - Fluted - 29°-35°	617294W
6' Stair Railing Kit - Fluted - 29°-35°	617296W
8' Stair Railing Kit - Fluted - 29°-35°	617298W
4' Stair Railing Kit - Fluted - 36°-41°	617364W
6' Stair Railing Kit - Fluted - 36°-41°	617366W
8' Stair Railing Kit - Fluted - 36°-41°	617368W

36" handrail height with 2" deck clearance

Bottom Rail Stair
Bracket 3250

Top Rail Stair Bracket
with Plain Cap

Top Rail Stair Bracket with
New England Cap



Series 3250 Porch Railing,
Round Fiberglass Columns



Series 3250 Stair Railing
Colonial Porch Posts

Series 3000 Specialty Brackets

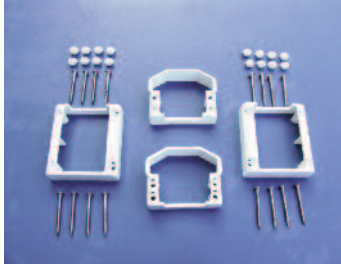

Level Railing Mounting Kit
62420W 62420B

Level Railing Mounting Bracket Kit

Use when cutting one level kit into two sections. For example, a 5' and 3' section could be made from one 8' kit. Mounts to wall or post with supplied stainless steel screws and screw covers.



45° Angle Bracket
62424W 62424B

45° Angle Bracket Kit

Use when connecting level rail to post or building at this angle. Mounts with supplied stainless steel screws and screw covers.

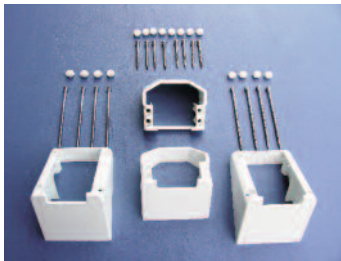

29°-35° Stair Bracket-A
62421AW 62421AB

Stair Mounting Bracket Kit-A

Use when cutting a kit into two sections for a stair with a rake angle of 29°-35°. Mounts to wall or post with supplied stainless steel screws and screw covers.

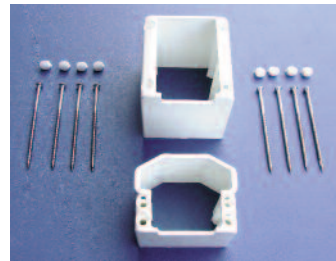

0-40° Bracket
62423W 62423B

0-40° Angle Bracket Kit

Can be cut on the job site for any angle between 0°-40° not covered by 22.5° or 45° angle kits. Mounts to wall or post with supplied stainless steel screws and screw covers.

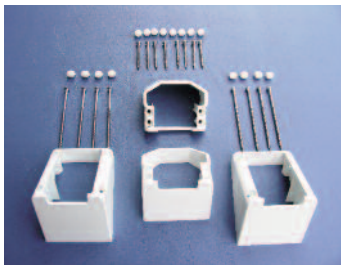

36°-41° Stair Bracket-B
62421BW 62421BB

Stair Mounting Bracket Kit-B

Use when cutting a kit into two sections for a stair with rake angle of 36°-41°. Mounts to wall or post with supplied stainless steel screws and screw covers.

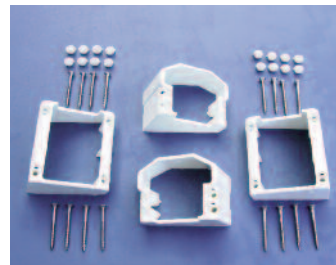

22.5° Angle Bracket
62421CW 62421CB

22.5° Angle Bracket Kit

Use when connecting level rail to post or building at this angle. Most common angle used in gazebos. Mounts with supplied stainless steel screws and screw covers.

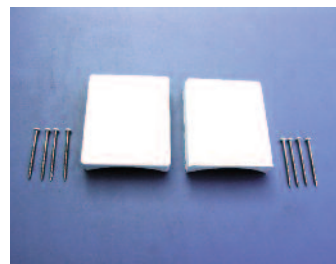

Round Column Bracket

604226W 604226B
604228W 604228B
6042210W 6042210B
6042212W 6042212B

Round Column Adapter Kit

Use this kit to attach level or stair railing to a round column. Specify: 6", 8", 10" or 12" column diameter.

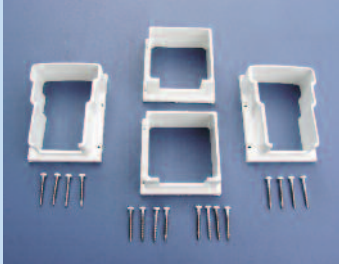

Level Railing Mounting Kit
61420W

Level Railing Mounting Bracket Kit

Use when cutting one level kit into two sections. For example, a 5' and 3' section could be made from one 8' kit. Mounts to wall or post with supplied stainless steel screws.



45° Angle Bracket
61424W

45° Angle Bracket Kit

Use when connecting level rail to post or building at this angle. Mounts with supplied stainless steel screws.

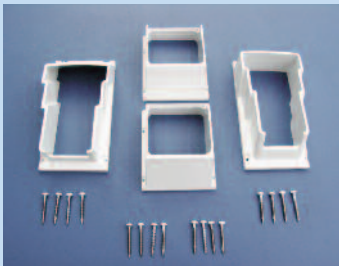

29°-35° Stair Bracket
61421W

Stair Mounting Bracket Kit

Use when cutting a stair kit into two sections for a stair rail with a rake angle of 29°-35°. Mounts to wall or post with supplied stainless steel screws.



22.5° Angle Bracket
61447W

22.5° Angle Bracket Kit

Use when connecting level rail to post or building at this angle. Most common angle used in gazebos. Mounts with supplied stainless steel screws.

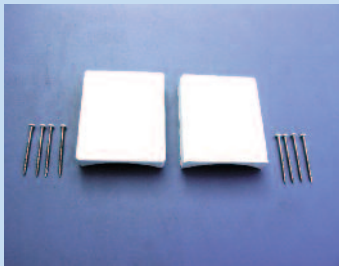

Round Column Bracket
604226W 604226B
604228W 604228B
6042210W 6042210B
6042212W 6042212B

Round Column Adapter Kit

Use this kit to attach level or stair railing to a round column. Specify 6", 8", 10" or 12" column diameter.

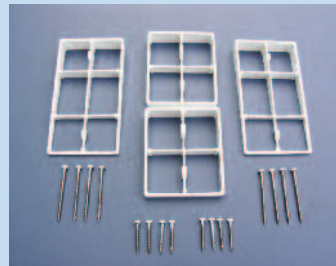

Adjustable Stair Adapter
61446W

Adjustable Stair Adapter Kit

Used in conjunction with 61421W stair bracket to increase the rake angle to 36°- 41°.

Column Cladding Accessories



4" Cladding Cap
60404CCW 60404CCB

Column Cladding Caps

Use this cap to trim smooth or fluted column cladding. Caps are available in 4" and 6" sizes.



6" Cladding Cap
60406CCW 60406CCB

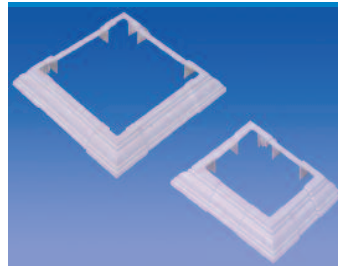

Cladding Base
604294W 604296W 604298W
604294B 604296B 604298B

Column Cladding Base

Use this base to trim smooth or fluted column cladding. Four-piece easy-lock bases are available in 4", 6" and 8" sizes.



Base Trim and Post Caps



4" x 4" Rounded Base
60440W 60440B

4" x 4" Rounded Base

Use to trim vinyl sleeves at the top or bottom. As a base trim, install before handrail.

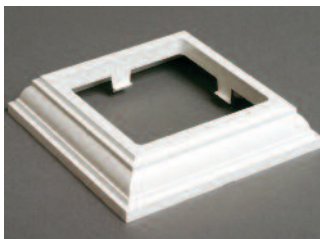

4" x 4" New England Base
60441W 60441B

4" x 4" New England Base

Use this for an upscale look to trim vinyl sleeves at the top or bottom. As a base trim, install before the handrail.



6" x 6" Rounded Base
60460W 60460B

6" x 6" Rounded Base

Use to trim vinyl sleeves at top or bottom. As a base trim, install before handrail.

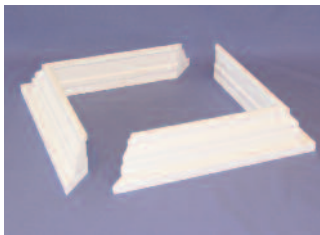

6" x 6" Two Piece Base
60460W2

6" x 6" Two Piece Base

Use this sleeve base for an upscale look. Can be installed on existing post with vinyl sleeve.

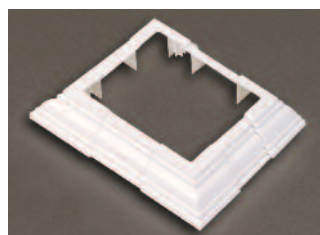

5" Colonial Post Trim
60159TW 60159TB

5" Colonial Porch Post Base/Cap Trim

Use this four-piece trim as a base or cap trim.

Post Caps

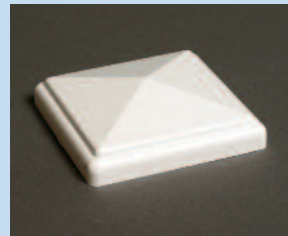

4" Flat Cap
60404FW 60404FB

4" Flat Cap

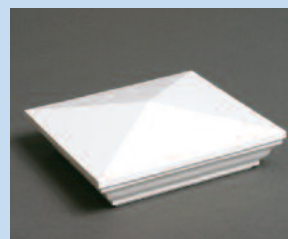

4" New England Cap
60404NW 60404NB

4" New England Cap



4" Ball Top Cap
60404BW 60404BB

4" Ball Top Cap



4" x 4" Gothic Cap
60404GW 60404GB

4" x 4" Gothic Cap

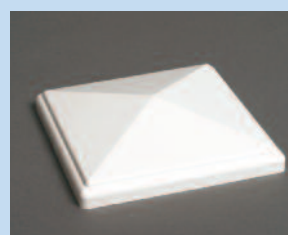

6" Flat Cap
60406FW 60406FB

6" Flat Cap

4" Fluted Porch Post Sleeves

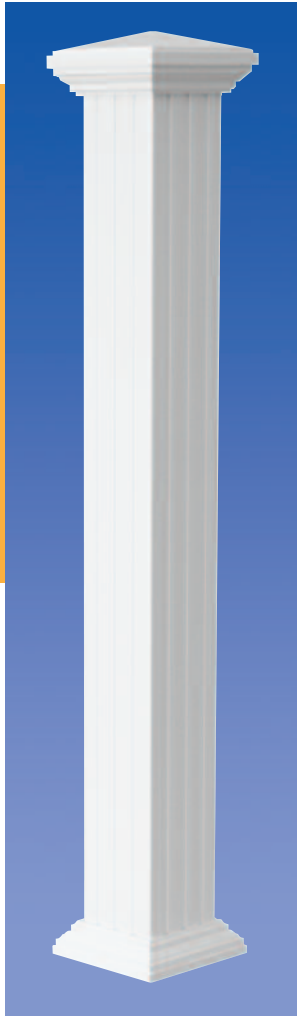

4" Fluted Post Sleeves

Fluted Post Sleeves add style and elegance to any outdoor application. The ultra-sharp corners and dimensional shadow lines achieve a remarkable wood-like appearance. Our New England style post caps and bases are designed to provide a classic architectural look. The Fluted Post Sleeves fit over nominal 4x4 wood posts or can be utilized with all-purpose surface mounts.

- Available in white, beige and clay colors
- Offered in a variety of lengths ranging from 38 inches up to 10 feet
- Available with our 4" x 4" x 8' Structural Porch Posts

Choose Top Rail Caps in 5 Colors

Our 3250 and 3000 Series Top Rail Caps offer a way to dramatically heighten the exterior appeal of a home with pleasing decorative colors to match the existing color scheme or introduce an entirely new look. The color Rail Caps fit over all rail lengths and are ready to add to any application. If a home is repainted, the color Rail Caps can be added or changed to suit any application. Our color Rail Caps provide an attractive addition to pair with our ProDek decking colors of Oak and Driftwood.

Size	White Fluted	Beige Fluted
4" x 38"	60438W	60438B
4" x 54"	60454W	60454B
4" x 108"	60408W	60408B

Available Color Rail Caps

Brick Red



Forest Green



Black



Oak

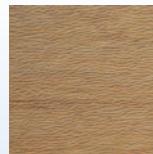

Driftwood

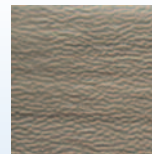

Railings and Screen-Clad Rail Kits



Available in 4' and 5' widths and 38" heights

Sturdy, Simple Railing Solutions with Screen Clad Rail Kits

The new Screen Clad Rail Kits are a simple solution for elevated screen porches. The easy-to-install kits provide additional safety without dramatically reducing airflow or the view. Now, you can use our mid-rail system with balusters to complete the look of a screened exterior application.



Sturdy construction in an easy-to-use kit

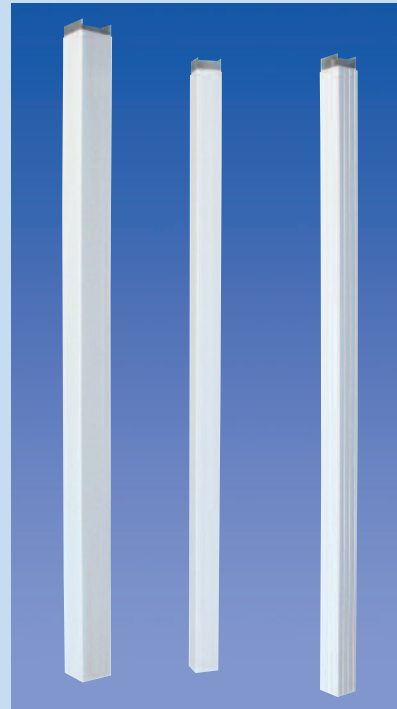

Structural Porch Posts—Ready to Install

Our 4" x 4" x 8' Structural Porch Posts are available in Fluted or Smooth, with a load bearing capacity of 6,800 pounds. The 6" x 6" x 9' Structural Porch Posts are available in Smooth and have a load bearing capacity of 22,800 pounds. Both systems are ready to install with all the hardware needed for both wood and concrete applications.

Size	White Plain	White Fluted
4" x 4 x 8'	60148PW	60148FW
6" x 6 x 9'	60169PW	

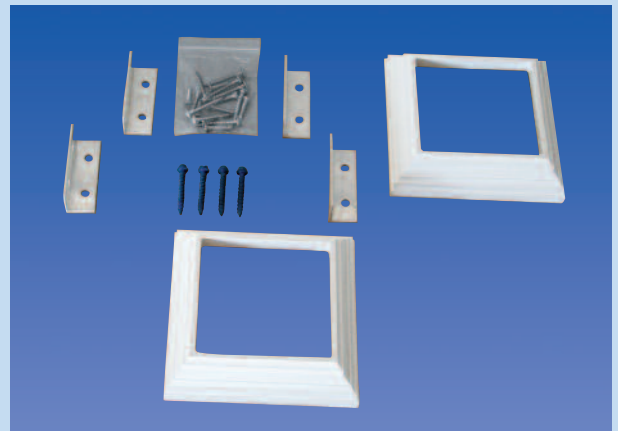

Sturdy construction in an easy-to-use kit

Screen Clad System



- Covers 4x4, 2x4, 6x6 and 2x6 structural components
- Easy to install
- Rigid PVC never requires painting
- Protects wood from UV and water damage
- Will not react with ACQ treated lumber

The patented Screen Clad System is an easy-to-install system that provides a low maintenance, attractive screen porch.

The system is just as easy to install on an existing screen porch, as it is for new construction—Simply attach base profiles, roll in the screen and tap in the attractive trim pieces.

Unlike wood or other screen systems, the Screen Clad system completely covers all porch components and uses a spline system for a professional installation of the screen sections.

Components used for installation include pieces to cover vertical posts, headers, sills and horizontal rails.



Size	Base	Cap	Cladding
2"	60BASE2WH	60CAP2WH	60CLAD2WH
4"	60BASE4WH	60CAP4WH	60CLAD4WH
6"	60BASE6WH	60CAP6WH	60CLAD6WH

Screen Clad System

Step 1



Install the vertical components around each post.

Simply measure and install all vertical components on each post. All four sides of the post will be covered.

Step 2



Install the horizontal components around all 2 x 4 railings.

Measure and cut each component to fit snugly around each 2x4. Attach screen base to outside face.

Step 3



Cut and install each screen panel.

Cut each screen panel to appropriate size and roll in spline to tighten and secure the screen.

Step 4



Install outside face components to finish.

After all screen is securely attached, simply cut and install the outside face components to finish the installation.



Gate Kits

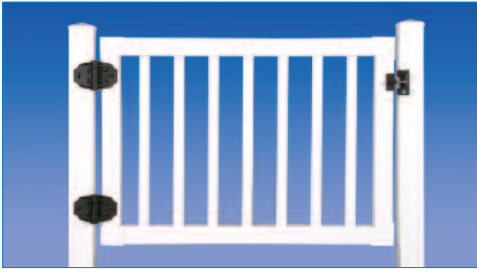

All kits come complete with black mounting hardware and installation instructions.

Gate Kits		
Dimensions	White	Beige
Gate Kit Square Balusters 48" W x 34" H	60834SW	60834SB
Gate Kit Square Balusters 48" W x 40" H	60840SW	60840SB
Gate Kit Turned Balusters 48" W x 34" H	60834TW	60834TB
Gate Kit Fluted Balusters 48" W x 34" H	60834FW	

Arndt & Herman Secondary Handrail

Our 1-1/2" round vinyl secondary handrail system is ideal for use with the Series 3000 or Series 3250 Railing System. The secondary handrail system may be attached to existing railing or as a stand-alone system, and can be customized for a home's exterior.

The aluminum reinforced secondary rail offers builders a simple and safe option and meets local or state building codes, as well as exceeding the requirements of the 1999 BOCA National Building Code. The 8' rail may be cut to length and is available only in white.

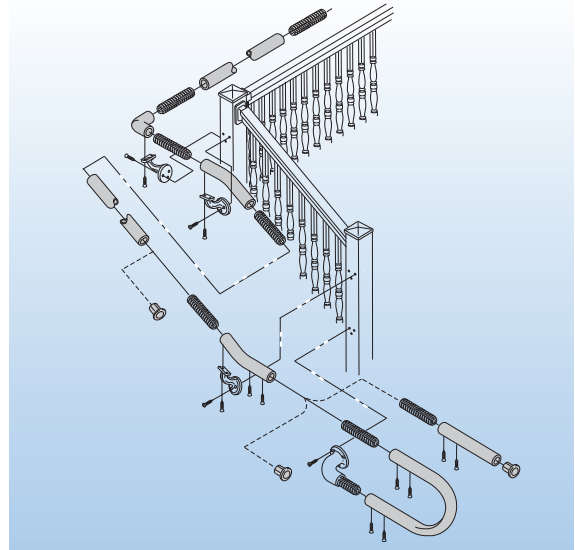

Components



For more information, contact
1-866-204-3139 or visit www.arndtandherman.com
Prices and products subject to change

ACB352/09.13.09/8000

Arndt & Herman
BUILDING PRODUCTS